

Easy Fit Touch Screen alarm system (EF-Panel)

Installation · Programming · Operating

Keep this manual safe for reference and future maintenance

Introduction

Thank you for choosing the Yale Wireless Alarm System. This simple to install system has been designed with the user in mind.

All the components are self contained and no connections are needed between the units. There is no need to damage the home decor, lift carpets or run cables.

You can install up to 20 devices in this system. As well as extra door/window contacts, PIRs and smoke detectors, you can add keyfob remote controls and keypads for added control convenience.

There is no need to wire into the mains supply or seek the services of a qualified electrician. The control unit is powered by a plug top supply and all other components are powered by battery (all batteries included). Batteries will operate for 2 years or more before they need changing. Regular testing and battery changes (when notified by the system) will ensure reliability and peace of mind.

The security detectors, control panel and external siren are 'tamper' protected. Any unauthorised tampering with these items will result in an alarm. This feature can be turned off by the user when a battery change is required.

Display extreme caution when using ladders or steps, please follow manufacturer's instructions.

Be careful when using hand and power tools and follow the manufacturer's guidelines when using them. Take care that the correct tools are used. Wear goggles or protective clothing where required.

The external Siren is extremely loud, please ensure you replace the cover and retreat to a safe distance before testing.

The dialling facilities must only be used with persons who have consented to being contacted by the system.

The system is not to be used to make 999 emergency calls directly. Yale do not hold responsibility for any actions taken by emergency services for incorrect use of the dialling facility.

Special Notes on Compatibility:

This alarm system is NOT compatible with SmartHome Alarm, HSA6000 series and HSA3000 series accessories. Please note the prefix "**EF-**" on the front of the part number to indicate compatibility.

Contents

Contents

1	Location planning	2
2	Unpack all the parts	4
3	First Time Easy Install	6
4	Mounting alarm devices	8
5	Control Panel Menu System in Detail	11
6	Using the System	17
	Adding and using Accessories	20
	Changing the batteries	22
	Troubleshooting	24
	Sensor response table	27
	Specifications	28

Recommended Installation Sequence

We recommend you follow the simple install sequence, headings numbered **1-6**.

Information and illustrations are subject to change within this document. Yale reserves the right to alter the specification and product design at anytime without notice. Yale® is a registered trademark. © 2012 ASSA ABLOY. All rights reserved.

1 Location planning

Work out the best places to locate the devices for maximum protection. Having chosen the locations do not mount at this stage.

Home and Away Mode Planning

The home arming mode allows the premises to be part armed so that no one can get inside without warning the occupier, yet the person already inside the house can move freely without triggering the alarm. For example the downstairs of a house can be armed while upstairs can be disarmed allowing the user to go to bed without causing an alarm.

If this feature is to be used, then it should be planned now, before installation.

Decide what areas can be occupied when in home arming mode, the sensors for these areas should be ignored using the "Home-arm set" option (see page 11); and the sensors activated on the path to access the control unit should be to be set to either Entry or Away Entry as explained in Chapter 5.

Operating Range

All devices must be within 30 metres of the control unit and must not be mounted on or near large metal objects. Avoid obvious sources of electrical interference such as fridges and microwave ovens.

Tamper Switches

When mounting devices ensure that any tamper switches close fully. On uneven surfaces it may be necessary to place packing behind the switch for reliable operation.

Extend The System

Extend the system in the future to increase your security or as your needs change. For example, add extra PIR detectors and extra door/window contacts.

Choosing Location

To minimise interference, avoid locating devices close to metal framework, glass, electrical appliances (especially wireless devices) and electric cables.

Please note that the present of high density material (metal, glass etc) in the transmission path will significantly reduce the wireless transmission range.

Keypad remote control accessory

When used as second keypad, it is ideal in bedrooms or at the top of a stairwell so the ground floor can be armed when going to bed for the night. Or, at a side or back door for alternative entry.

- Mount at chest height for ease of use
- Designed for indoor use only
- Keypad should be accessible from a protected entry/exit point
- Ensure that the keypad is not visible from the outside of the premises.

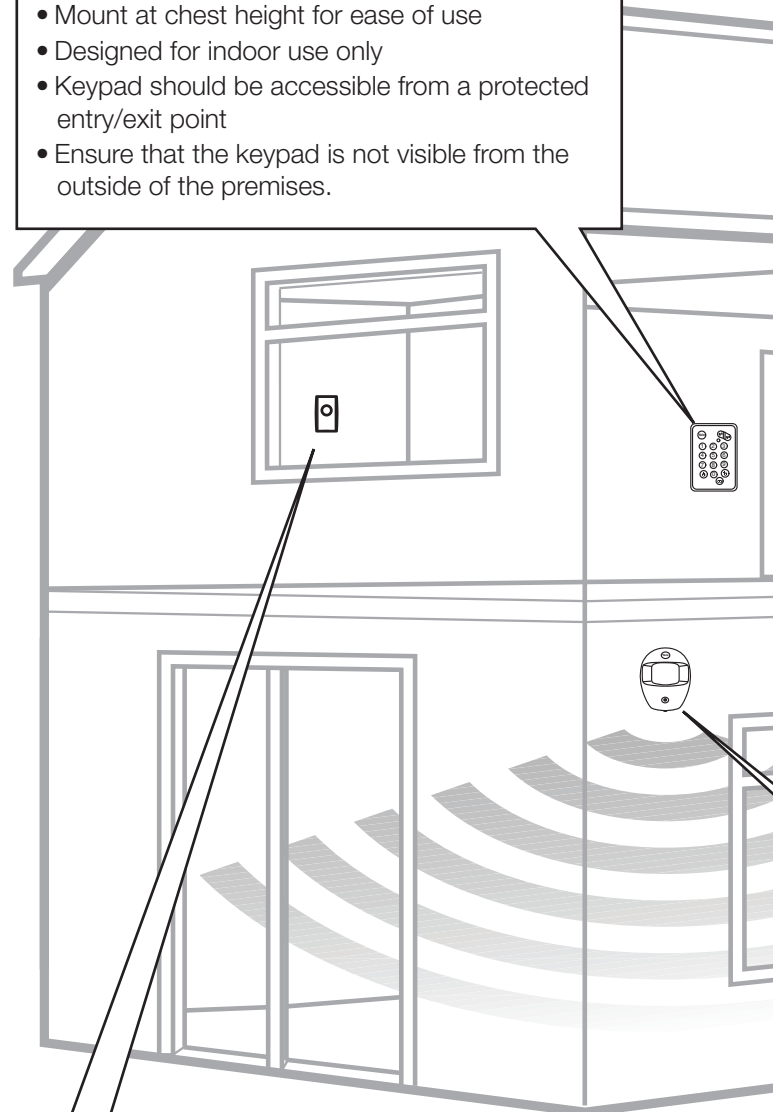

Help button accessory

The help button provides extra protection for you and your family. When help is needed the button can activate your alarm immediately - even when the system is disarmed.

- Mount on flat wall surface
- Designed for indoor use only
- Out of reach of children
- Hidden from view while easily accessible.

Smoke detector

- Mount in the middle of the ceiling at the top of a stairwell, or on the centre of hallway ceilings where smoke would most likely be detected.
- Do not mount in corners or above cooking appliances and heaters.
- Install additional detectors if there are closed doors preventing smoke from reaching detectors.

Siren

Choose a position on an external wall where the siren would be most prominent. Mount as high as possible, out of easy reach.

Door/Window contact

Select a door that will be the main point of entry and exit, usually your front door.

- Mount as high as possible
- Do not aim a PIR at this door or window

Keyfob remote control accessory

Can be used inside or outside the property and can be kept on your keyring.

PIR movement detector

- Mount in a position such that an intruder would normally move across the PIRs field of view.
- Height should be between 1.9 and 2 metres above floor level.
- Location in a corner will ensure wider room coverage.
- Do not mount the PIR where its field of view will be obstructed e.g. by curtains, ornaments etc.
- Do not point directly at sources of heat e.g. fires or boilers, and do not position directly above radiators.
- Avoid mounting the PIR directly facing a window.
- Do not point the PIR at a door protected by a door/window contact.

Control unit

- Ensure it is hidden from view while accessible.
- Access to mains socket and telephone point.

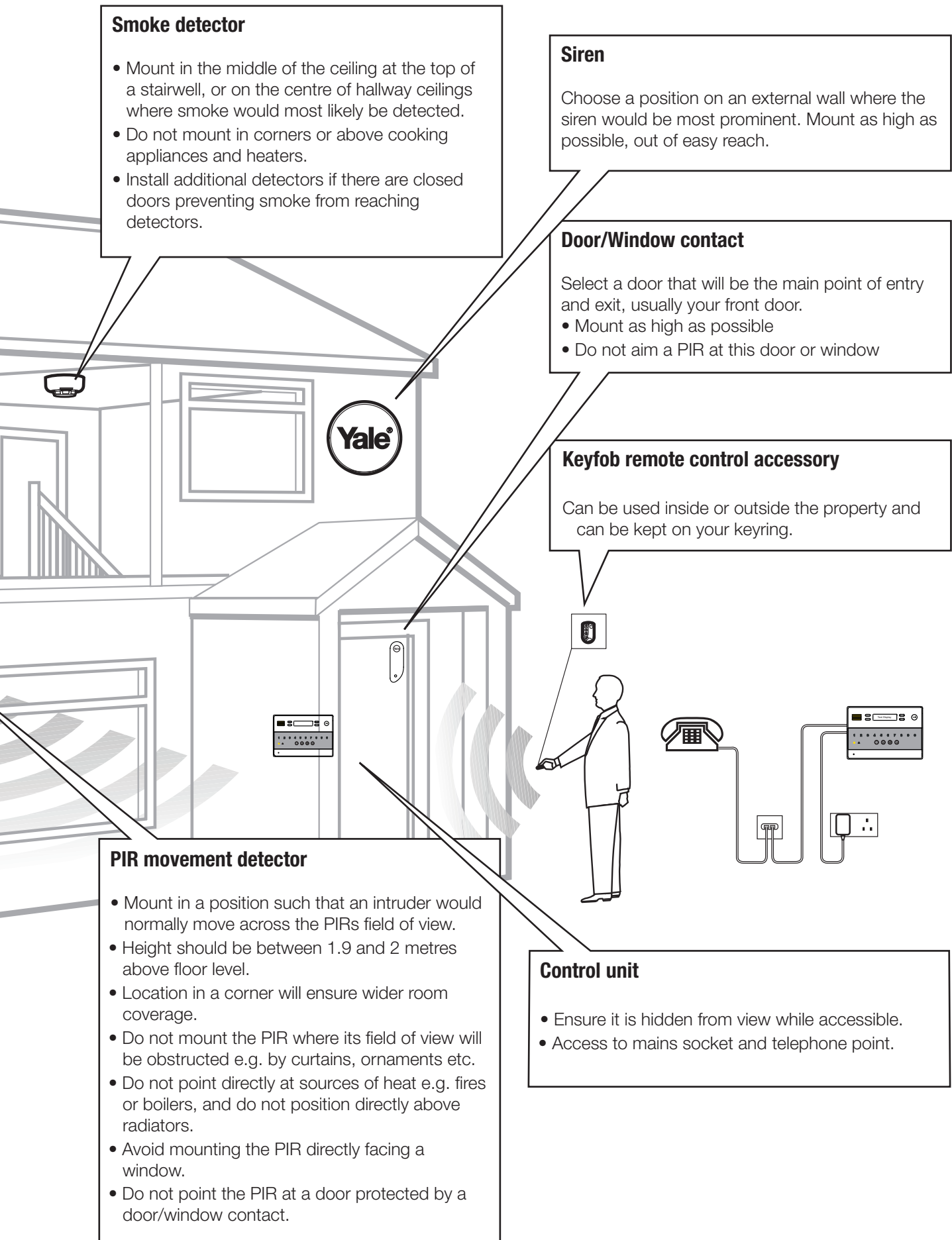

2 Unpack all the parts

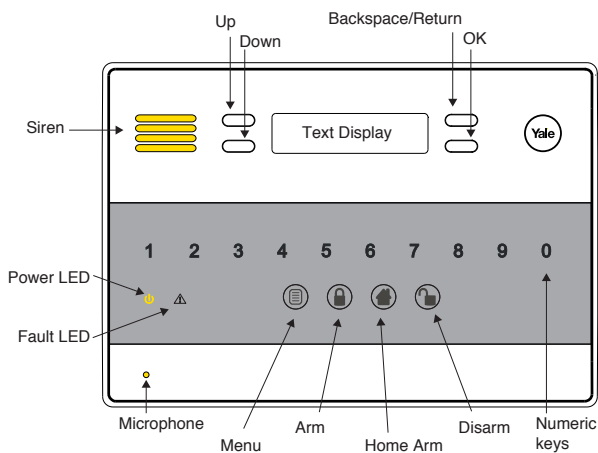

Control unit

Unpack the kit content on a table. Remove the mounting plate (if fitted) from the control unit by sliding plate downwards. A power adaptor is supplied that plugs into the main wall socket and control unit. Do not plug in at this stage, this will be done at Section 3.

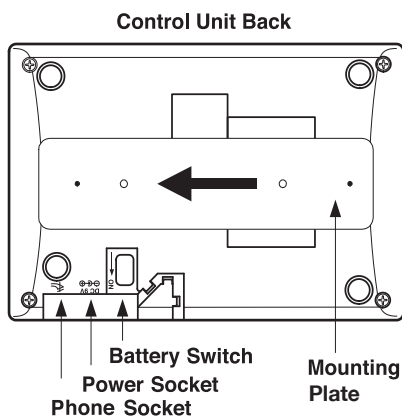

- In addition to the adaptor, there is a rechargeable battery inside the control unit that serves as a backup in case of a power failure. A fully charged battery can provide backup power for a period of at least 10 hours. It takes approximately 36 hours to fully charge the battery. The control unit is equipped with a backlit LCD display and keypad for easy operation in the dark. To conserve backup battery duration the backlights will be switched off during mains power failure.
- Remove the rubber battery switch cover and locate the battery switch to the right in the direction of the arrow to switch the internal battery "on" and replace the rubber cover.

Siren

WARNING

The siren is very loud, be prepared! Take care not to activate the siren tamper switch unnecessarily.

- 1 Remove the cover by unscrewing the single screw located on the lid.
- 2 Power switch to ON position.

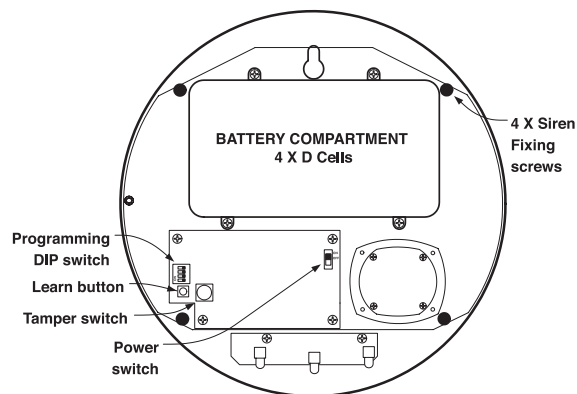

PIR movement detectors

- 1 Pull out the plastic pull tab on the back of the PIR. This will activate the batteries.

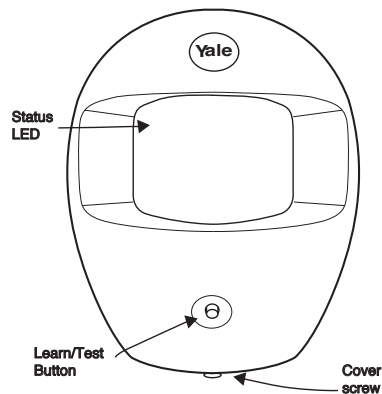

Door/window contacts

- 1 Pull out the battery saver tab on the side to activate the battery.

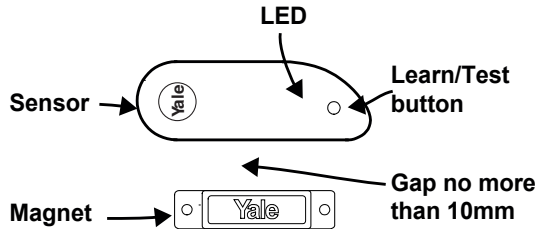

Keyfob remote control accessory

- 1 Open the battery compartment using a coin by turning cover in the direction of the big arrow so the cover small arrow is next to round dot.
- 2 Insert CR2032 battery and replace cover.

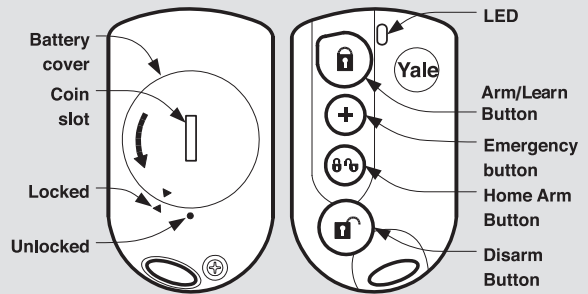

Smoke detector accessory

- 1 Remove the cover and insert three AA batteries
- 2 The Smoke detector will now enter into self-calibration mode for 15-20 minutes. It will resume normal operation after this period.

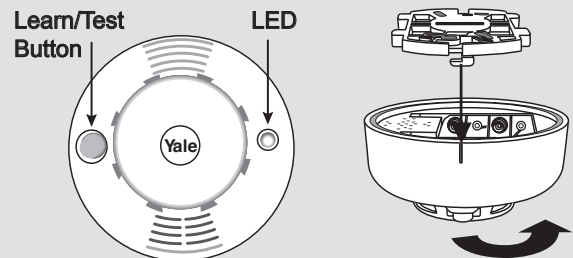

Keypad remote control

- 1 Pull out the plastic battery saver tab at the back of the remote keypad. This will activate the batteries.

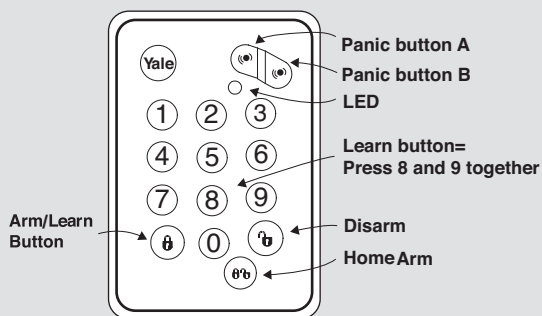

Help button accessory

Remove the cover by loosening the fixing screw and insert the CR2032 battery (supplied) as shown (1). Please ensure you observe battery polarity.

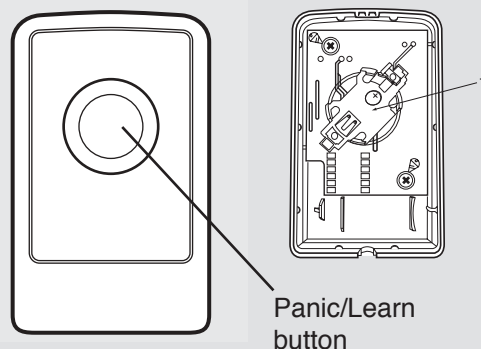

3 First Time Easy Set-up

The installation guide will provide you with prompts to easily set-up the system.

- i** Any omissions or mistakes can be rectified later. Once the first time install has been successfully completed it will not be shown again.
- More advanced programming can be done at a later stage including adding and naming sensors and changing various settings.

Connect the mains power adaptor to the control panel (in the intended location). After the welcome screen, the display will show:

3 STEPS EASY
SETUP (OK?)

Press OK (✓) to continue. You are 3 steps away from completing the initial set-up.

1. Set Time/Date

SET DATE/TIME
(OK?)

Press OK (✓) to continue.

SET DATE, PRESS
OK WHEN DONE (OK)

Press OK (✓) to continue.

DATE SETTING
01 JAN (▲▼OK)

Set the current month using the ▲/▼ key. Press OK (✓) to confirm setting. Set the day using the ▲/▼ key. Press OK (✓) to confirm setting. After setting the day, it will now prompt you to set the time.

Set the current time using the ▲/▼ key. Press OK (✓) to confirm the hour, follow by setting the minutes.

2. Set the phone number to alert

SET 1 PHONE NUM
FOR ALERT (OK?)

Enter a phone number to be alerted in the event of an alarm.

Press “Up arrow” key for * key (3 seconds time gap, useful for switchboard) and “Down arrow” key for the # key.

Press OK (✓) to continue.

Press Return button to skip if you do not want any alert through the phone.

3. Set the Pincode

SET PIN CODE
.....

Enter the four digit pincode you would like to use (e.g. 1234). Press OK (✓) to continue.

Next, the screen will display:



.EXIT SETUP
REPEAT SETUP

Upon selecting “Exit Setup”, you will now be prompted with:



MOUNT DEVICES,
SEE MANUAL

Please leave it on this screen and proceed to mount all your devices (see Chapter 4).

Note: If a different prompt is shown, please see section on the right.

Error Condition (Upon selecting Exit setup)

If there are no device/accessory (accidentally deleted) in the system and you selected “Exit Setup”, you will be prompted with “Please add at least one device”.



PLEASE ADD AT
LEAST ONE DEVICE

If you see this message, please press the test/learn button on all your accessories (including the Siren) **one at a time**.

Every time a button is pressed, the screen will prompt the device and you will need to press OK on the panel to acknowledge/add. It would then be reverted to the “Exit Setup, Repeat setup” screen. Please press the learn button on the next device and repeat the above steps. Please ensure all the devices are added one by one.

Choose “Exit setup” once everything is added.

Alternatively, should you wish to finish initial setup with no device learnt-in, you can force exit by pressing disarm and then followed by the pincode.

You will now be prompted with:



MOUNT DEVICES,
SEE MANUAL

Please leave it on this screen and proceed to mount all your devices (see Chapter 4).

4 Post Installation/Mounting Devices

Note: Tamper is disabled during initial set-up. For details on disabling tamper see Section 6

Control Unit Mounting

Wall Mounting

Using the two holes on the mounting back plate, mark the position of the holes. Drill two holes and fix with the screws and plugs provided. Hook the control panel onto the plate. Ensure that the control unit is fitted at approximately chest height where the display can be easily seen and the keypad convenient to operate.

- The control unit tamper protection will automatically arm when mounted on the back plate.

NOTE: At this point, the control panel screen should be showing:



MOUNT DEVICES,
SEE MANUAL

Mounting other devices

Find a location where the device is to be mounted, see section "Location Planning" for suggestions.

Before proceeding to mount the devices physically, check that the control unit will receive the system radio transmissions by doing a simple radio range test.

Please make sure the control unit screen is displaying:



MOUNT DEVICES,
SEE MANUAL

Hold the devices in the desired location and press the Test/Learn button (see below) on the accessories.

- **KEYPAD:** press button 8 + 9 together.
- **ALL OTHER DEVICES:** Hold the device in the desired location and press the learn/test button, the control unit should respond with a chime.

If the sensor signal reached the control unit, the screen will briefly display:



DC ZONE01 B 6
.....

***Note: this screen shot is use as example only.**

The radio signal strength is shown by a number on the upper right (6 in this case). this number ranges from 1 to 9 (strongest). Where possible please ensure sensor shows 5 or above for optimal performance.

When you are happy that all your devices can communicate with the panel, press the Green "Disarm" button and enter your pincode that you previously defined. The screen will now show:



ALARM OFF
00:00 01 JAN

Leave it at this screen and proceed to mounting the accessories as detailed below. The fault light/beep maybe activating periodically and you can ignore that until you finished mounting.

Mounting the siren

Ensure the tamper switch is fully depressed when the siren is mounted. If there is a gap, pack with a suitable spacing material.

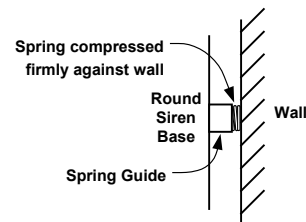

- 1 Using the large screws and wall plugs provided, screw the siren onto the wall through the 4 mounting holes on the siren base.
- 2 Fix the siren cover with the securing screw.

Mounting the PIR

- 1 Open the PIR by loosening the bottom screw. Knock out the relevant holes on the base where the plastic is thinner. The center two knockout holes are for flat wall mounting while the 4 side holes are for corner mounting.

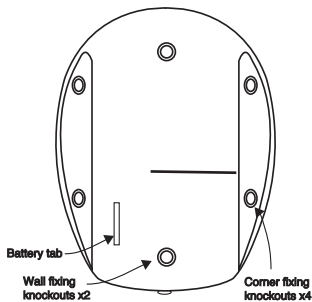

- 2 Drill holes into the wall using the knockout holes on the base as a template.
- 3 Fit wall plugs and secure the PIR base with the screws provided.
- 4 Fit the PIR back together and tighten bottom screw, the PIR installation is complete.

Mounting the Keypad:

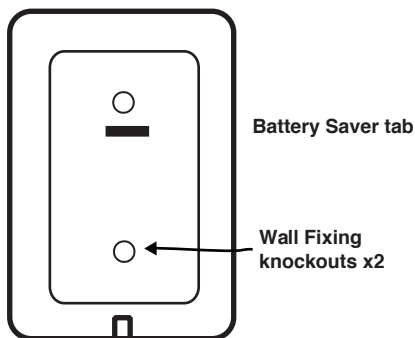

- 1 Knock out the fixing holes. Drill holes into the wall using the fixing holes as a template.
- 2 Fit wall plugs into the wall and fix back cover with the screws provided. Fix front of the keypad onto the back plate.

Mounting the Door Contact

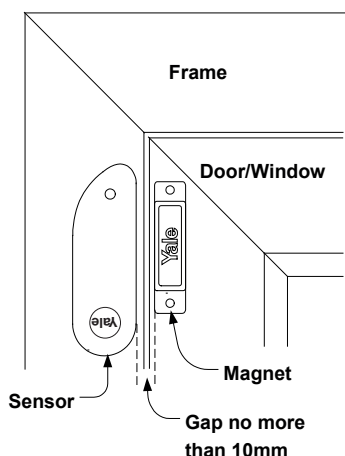

- 1 Find a location on the door/window where you would like the device to be mounted. The sensor should be on the frame while the magnet should be on the door/window. Once mounted make sure the tamper switch spring is fully depressed.



The gap between the magnet and sensor should be no more than 10mm when closed (maybe shorter depending upon the actual environment).

Simple test to see whether the magnet is in range of the sensor: hold the magnet and sensor in place and then pull them apart. If the sensor LED lights up it implies the two items are within range.

-Mounting using adhesive pads

Clean the mounting surface with a suitable degreaser agent. Please note that some surface or environment (i.e. exposure to Sunlight) maybe unsuitable for this mounting method. Please use screw mounting in these cases.

-Mounting using screws and wall plugs

Loosen the bottom screw and open the door/window contact. Knock out the holes on the base as shown. Drill holes into the mounting surface using the holes in the knockouts on the base as template. Fit wall plugs (if required) and secure with the screws provided.

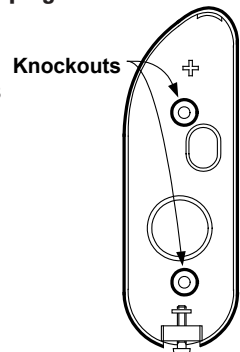

Mounting the Help button

- 1 Break through the knockouts (where the plastic is thinner).
- 2 Using the holes as a template, drill holes in the surface and insert wall plugs if fixing into plaster or brick. Screw the rear case to the wall.
- 3 Replace the cover and tighten the screw.

Mounting the Smoke Detector

- 1 The base has two mounting slots. Using the slots as a template, drill holes and insert the wall plugs if fixing to plaster. Screw the rear case to the ceiling using the screws provided.
- 2 Replace the main unit onto the bracket.

About your alarm system (default settings)

All accessories were pre-set to “entry” attributes.

When the system is first armed, user will have 30 seconds to exit the building. System will ignore any sensors triggering in this duration.

If the system is already armed, triggering any sensors will cause an entry countdown to begin.

i To change the exit and entry timer, see Chapter 5, Adv. Settings.

To change the property of individual sensor (i.e. Burglar attribute where the individual sensor will instantly alarm when triggered), see Chapter 5, Devices, Edit Devices.

Home arming is disabled by default. If you need Home arming function, see Chapter 5, Home-arm set.

When the alarm is triggered, the system will dial out to alert the owner.

i To set up more telephone numbers (maximum 3 in total), please see Chapter 5, Tel. Settings.

When the alarm alerts you via telephone, it will playback the address message: “Yale Alarm System” follow by the specific event message (i.e. burglar).

i You can record a custom address message that will be playback before the event message. Please see chapter 5, Tel. Settings

Siren length is set to 3 minutes.

i To change, please see Chapter 5, Adv. Settings, Alarm Length.

As default, it is possible to arm the system with “open” Door contact (i.e. windows open).

i You can prevent arming when door contact is opened. Please see Chapter 5, Adv. Settings, DC Open/close.

When using a keyfob, you will need to trigger the entry timer (triggering a sensor) before you can disarm the system with the keyfob.

i To change and allow disarming the system (using keyfob) prior to you entering the building, Please see Chapter 5, Adv. Settings, KF Entry.

Jamming and interference detection disabled as default.

i If Jamming and interference is of concern, please see Chapter 5, Adv. Settings, Jamming Det for option.

5 Control Panel Menu System in Detail

Entering Programming Mode

The programming mode is for you to configure the system, and make any changes to the pre-set functions.

If the system is in Disarmed (Alarm off) mode, follow the steps below to enter the programming mode.

- 1 Press 'menu'  key on the control panel.
The screen will prompt you to enter the PIN code.

		P	-	M	o	d	e	e	n	t	e	r		
		P	-	C	o	d	e			

- 2 Key in your PIN code within 30 seconds.

Note

- Press  to clear the entered PIN. If the code field is empty, it will return to the Alarm Off screen.



- 3 Press  to continue.
The following message is displayed for 2 seconds.

		P	r	o	g	r	a	m	m	e	n	u		
M	a	k	e	a	s	e	l	e	c	t	i	o	n	



- 4 Then the Programming Main Menu will typically be displayed.

*	S	y	s	t	e	m	t	e	s	t				
H	o	m	e	-	a	r	m	s	e	t				

Note

- The cursor is indicated by a flashing dot on the left upper corner. It can be moved up and down by pressing   respectively.

- 5 The following items can be selected:
 - Fault log (only if there is a fault condition)
 - System Test
 - Home-arm set.
 - Devices
 - Log
 - Adv. Settings
 - Tel. Settings

- 6 After making a selection by moving the cursor to the desired item, press  to confirm the selection. The display will show you the individual programming screen accordingly. Selecting  will return to the Alarm Off screen.

Important Note

- In programming mode, if no key is pressed within 5 minutes, the panel will exit the programming mode and return to the Alarm Off screen.

System Test

When System Test is selected, you will be given 4 different options: Sensor Test, External Siren (test), Panel Siren (test) and Phone alert.

Sensor Test:

three beeps will sound during a screen self test. This allows you to test the system without causing an alarm. To test the control panel is receiving a signal, do one of the following depending on the device:



- 1 Press button 8 and 9 together on the keypad

- 2 Press the test/learn button on the sensor

- 3 Press the help button

A chime will sound and the display will show you which device is transmitting. The upper right corner will show the radio signal strength ranging from 1 to 9 (strongest). Relocate the sensor if this is below 5 (unstable).

Ext. Siren and Panel Siren (test):

- The external siren and control unit (panel) siren can be tested by pressing  when prompted. Press  once more to stop the siren.

Phone alert:

- Select this option for a test call via phone dialer.

Home-arm set.

The home mode allows the home to be partially armed so that no one can get inside without first disarming the system. However, the person inside the house can move freely around without triggering the alarm. Home mode is usually used to protect the ground floor when you are upstairs in bed.

To enable home arm, you will first need to choose the sensors to be ignored during this mode. It would typically be the bedroom PIR etc if you want to arm your system during the night.

Selecting this option, the screen will display:

**PRESS TEST ON
SENSOR TO IGNORE**

If you press any test/learn button on any learnt-in sensor (confirm by pressing ✓), these sensors will be ignored during the Home Arm mode.

Repeat this step to ignore additional sensors.

Devices

Select 'Devices' in the main programming menu to add or remove a device. From here you will be able to view a list of all the devices being installed and you can add or delete devices. The following items can be selected.

- Add Device
- Edit Devices
- Remove Device
- Program Siren

Add Devices

1 To learn-in a new device select 'Add Device' then press ✓, a "push Button on Device to Add" message will be shown.

2 Press the learn button on the device within 30 seconds (see Chapter 2 for location).

3 If a signal is detected, the screen will show the type of device found. The upper right corner will show the radio signal strength ranging from 1 to 9 (strongest). Relocate the sensor if this is below 5 (unstable).

• Devices are labeled by the following codes within the control unit:

- Door Contact DC
- PIR Sensor IR
- Smoke Sensor SD
- Remote Keyfob RC
- External Siren BX
- Remote Keypad KP
- Help Button FP (Fix-Panic)

• When a sensor is added to the system for a second time, an error "Already in System" message will be briefly displayed and the control unit will wait for another learn-in signal.

4 Press ✓ to confirm the device type.

5 The following zone types will need setting for door contacts and PIRs:

- Burglar

- Home Omit
- Entry
- Away Entry
- 24 Hour (DC only)

The following devices have a fixed **emergency zone type**:

- Smoke Detector
- Remote Controller emergency Button
- Help Button
- Remote Keypad dual emergency buttons
- Control Unit dual key emergency (1 and 3) keys

Zone Type List

Burglar

- When the system is in home or away armed mode and a burglar device is triggered, a burglar alarm will be activated immediately.
- A device set to burglar will not trigger an alarm during entry or exit delay periods.

Home Omit

- A home omit device will be ignored when the system is home armed.
- A home omit device will give a burglar alarm when the system is away armed.

Entry

- If an entry device is triggered when the system is either away or home armed, it will start an entry delay period to give enough time to disarm the system.
- If the delay period expires without being disarmed, the control panel will respond with a burglar alarm.
- If the device has been set to entry and triggered when the system is in disarmed mode, the control unit will make a 'ding-dong' door chime sound if the door chime feature is enabled.

Away Entry

- If an away entry device is triggered when the system is in armed mode, the control unit will start an entry delay period to give enough time to disarm the system.
- If the delay period expires without being disarmed, the control panel will respond with a burglar alarm.
- An away entry device is ignored when home armed.
- The device will not give a "ding dong" chime sound when door chime is selected.

24 Hour

- The door contact is the only device that has this zone type, the PIR does not.

- A 24 Hour door contact is active all of the time and does not have to be armed or disarmed, if triggered a burglar alarm will be activated immediately.

Emergency

- An emergency device is active all of the time does not have to be armed or disarmed, if triggered an emergency alarm will be activated immediately.

Edit Devices

To edit all of the devices that has already been installed, choose 'edit devices' in the device +/- menu. All of the devices included in the system will be displayed.

- 1 Use ▲▼ keys to scroll the display and choose the device for editing. Press ✓ to select. Depending on the device a list of zone types will be given, otherwise you will be asked to enter a name.
- 2 If available select a zone type and press ✓ to confirm.
- 3 After confirming the zone type (if available), you are now asked to enter a name. Press ✓ to confirm or ⏪ to cancel without naming.

Device Naming

- Each device can be given a 12 character name. Names can be given either when first adding a device or by editing them later.
- When the "Enter New Name" screen is displayed the numeric keyboard can be used to enter text. Simply find the corresponding numeric key with the required character and press repeatedly until the wanted character appears. Release the key and the flashing cursor automatically jumps to the next position for you to continue with the next character by the same method.
- The keys have the following functions:
 - 1 1
 - 2 2ABCabc
 - 3 3DEFdef
 - 4 4GHIghi
 - 5 5JKLjkl
 - 6 6MNOnno
 - 7 7PQRSpqrs
 - 8 8TUVtuv
 - 9 9WXYZwxyz
 - 0 0 <space>/&'."+
 - ⏪ Backspace and delete
- The name can be erased by clearing the display by pressing ⏪ repeatedly, followed by ✓.

- 4 Press ✓ when completed to confirm the name and return to the device list.

Remove Device

To delete a device choose 'remove device' in the "Edit device" menu. A list of all programmed devices will be shown.

- 1 Use ▲▼ keys to select the device you wish to delete and press ✓.
 - 2 The selected device will be displayed again, press ✓ to confirm deletion or ⏪ to return to the device list without deleting.
- If a device name has not been programmed the screen will show the preset zone number instead.

Program Siren

To program the siren, select 'program siren' in the "Edit device" menu. The following items are available in this menu:

- Siren Tamp. On
- Siren Tamp. Off
- Confirm On
- Confirm Off
- Entry Snd On
- Entry Snd Off
- Comfort LED

Siren Tamp. On, Siren Tamp. Off

The siren tamper switch can be enabled and disabled remotely.

- The siren tamper protection automatically switches back on after one hour.

Confirm On, Confirm Off

The siren can be enabled for arming and disarming confirmation where one pip and flash is given for arming, with two pips and flashes from side to side for disarming.

Entry Snd On, Entry Snd Off

The entry and exit warning beeps can be echoed on the siren.

Comfort LED

If enabled, the siren LED will flash periodically according to the set interval. This will reduce the battery life accordingly. Select disable to disable this function (Default Off).

Log

The alarm log memorises the last 30 system events including:

- All alarm events with device names and type
- All fault warning events
- All arming and disarming events
- The logged events are displayed in reversed chronological order (most recent event first).
- The log is marked with a 'start' label before the most recent entry and 'end' after the oldest entry.

To view log:

- 1 Select the Log menu and press ✓.
- 2 The log can now be scrolled up and down and viewed with the ▲▼ keys; the most recent event will be at the start.
- 3 The first line displays the time and date of the event, the second line displays the type of event and the third line either states the user or the device that caused the event. Abbreviations used are:
 - "LB": low battery
 - "Tamp": tamper
 - "R": restore.
 - AC: mains power
 - Panic: emergency
 - Perimeter: entry or away entry device
 - Cancel: silencing an alarm with a help button

Adv. Settings

The settings will initially have factory default values. If you do not want to change them then you can escape any menu by pressing ⏪ without making changes.

The following items are available in this menu:

- Pin Code
- Entry Time
- Exit Time
- Entry Sound
- Exit Sound
- Door Chime
- DC Open/Close
- LCD Backlight
- Key Tone
- Ring Tone
- Alarm Length
- C.U. Siren
- Jamming Det

- KF Entry
- Tamper Alarm
- Mobility CHK
- Siren Delay
- Warning Beep
- Time
- Date
- Supervision

Pin Code

The PIN Code (password) is used to configure the control unit and to disarm the system.

- To disarm, press the 'disarm' key followed by your PIN code.
- To enter the program menu press the 'menu' key, enter a PIN code followed by ✓.
- Up to 4 Pin codes can be stored.

- 1 Select 'Pin Code' then press ✓, a list of 4 PIN codes will be shown, occupied codes are shown with ****. The list can be scrolled up and down using the ▲▼ keys.

- 2 Select the code you want to change and press ✓, enter your new PIN code and press ✓. You will be asked to repeat the PIN code, enter it again and confirm by pressing ✓, the new code is now programmed.

- ⏪ can be used to correct entry errors, pressing ⏪ repeatedly will return you to the PIN code list.
- User 1 code can only be changed and cannot be erased. All other codes can be erased by selecting them and pressing ✓.
- An error message will be shown if either an incorrect repeat code is used or a duplicate code is entered for another user. All codes have to be different.

Entry Time

Note: Ensure device is set to entry on control unit for the entry time to work (see section 5, Add Devices)

Entry time gives you a delay to allow you time to enter your premises and disarm the system. Times can be set from 00 seconds (no delay) up to 70 seconds in 10 second increments.

- 20 seconds is the factory default.

Exit Time

Exit time gives you a delay to allow you leave you premises before the system arms. Times can be set from 00 seconds (no delay) up to 70 seconds in 10

second increments.

- 30 seconds is the factory default.

Entry Sound

The control unit will beep during the entry delay period as an entry warning, you can switch the sound on and off with this setting.

- Entry sound on is the factory default.

Exit Sound

The control unit will beep during the exit delay period as an exit warning, you can switch the sound on and off with this setting.

- Exit sound on is the factory default.

Door Chime

Any door contact or PIR set to entry will cause the control unit to chime when activated when the system is disarmed. This is used to signal when anyone has entered your premises. You can switch the sound on and off with this setting.

- Chime off is the factory default.

DC Open/Close

If this is turned On, the control panel will sound a door chime and display a fault message when user tries to arm the system with Door contact opened.

- DC Open/Close Off is the factory default.

LCD Backlight

The control unit display LCD can be turned on Permanently or set to auto turn off after 30 seconds of last key pressed.

- Auto off is the factory default.

Key Tone

The control unit can be made to beep when a key is pressed. Key Tone can be selected to On or Off.

- Key Tone On is the factory default.

Ring Tone

The control unit can be made to beep when the phone is ringing, you can switch the sound on and off with this setting.

- Ringing off is the factory default.

Alarm Length

The siren (both external and built-in) will sound when an alarm is activated. The length of the alarm can be set from 1 to 10 minutes in 1 minute increments with this setting.

- 3 minutes is the factory default.

C.U. Siren

You can disable the control unit's built-in siren with this setting.

- Siren on is the factory default.

Jamming Det

Enable or disable Jamming/Interference detection on the control panel. Confirmed by pressing the ✓ key. Default setting is Disable (recommended).

KF Entry

When selected as Off, user must first trigger an entry sensor before the keyfob can disable the system. Please select On if you wish to disarm the system without first triggering an entry sensor.

- KF Entry Off is the factory default.
- If the Keyfob's Panic button is triggered, the same keyfob cannot be used for disarming the siren.

Tamper Alarm

If set to Away Arm only, it will trigger the alarm when tamper is active under away arm mode (also known as full arm). It will only give a fault LED indication in all other mode. If set to Normal, a tamper condition will always trigger a burglar alarm under disarm, home arm and away arm mode.

- Away Arm Only is the factory default.

Mobility CHK (for elderly or infirm)

If there is no movement around the house for a preset period of time (from home omit sensors under part arm and all sensors under disarm mode), an emergency alarm will be activated and reported over the telephone line. Any key presses on the panel and entry sensor triggering will reset the countdown timer. The monitoring can be disabled or set at 4, 8 and 12 hour.

- Disable is the factory default.

Siren Delay

This setting allows a delay before the control unit and external sirens are activated. You might want to use this if you do not want the control unit to draw attention to itself during an alarm, to give it time to dial out on the telephone line. The delay can be set from Disable (no delay) to 10 minutes in increments of 1 minute.

- Disable is the factory default.

Warning Beep

The control unit will give a reminder beep every 30 seconds in the event of a system fault, such as tamper or a low battery etc. This setting allows this feature to be switched on and off.

-
- Warning on is the factory default.

Time

The control unit uses a 24 hour clock. The time is set by using the ▲▼ keys and confirmed by pressing the ✓ key.

Date

The day and month are set by using the ▲▼ keys and confirmed by pressing the ✓ key.

Supervision

Enable or disable supervision detection on the control panel. PIR, Door Contact, Smoke Detector and Siren can be monitored for outage using this feature. Except for Smoke Detector (which is always on), the other three accessories need to have supervision enabled on board to facilitate this feature.

- Default setting is Disable (recommended).
-

Tel. Settings

This menu allows you to program up to 3 telephone numbers, record an address message and place test calls, The following items can be selected.

- Tel. Numbers
- Rec. Address
- Test Report

Tel. Numbers

This menu has a list of 3 telephone numbers. These numbers are dialed in order, a maximum of 20 digits per number can be stored. Only one number is required to enable the control unit to report over the telephone line.

- 1 Use the ▲▼ keys to select a number from the list.
- 2 Press ✓ to confirm. If there was a number already stored then you will be asked to change the number, if the slot was empty you will be asked to enter a new number, confirm by pressing ✓.

- 3 Enter your phone number and confirm by pressing ✓. Press “Up arrow” key for * key (insert 3 seconds time gap, useful for switchboard) and “Down arrow” key for the # key.

- Errors can be corrected by pressing ⏪ to backspace, pressing ⏪ repeatedly will take you back the telephone number list. Telephone numbers can be deleted in the same manner.

Rec. Address

This menu allows the recording of your address. The maximum length of message is 10 seconds which is ample for most messages, when recording remember to speak clearly and slowly into the microphone.

- 1 Press ✓ and you will be either asked to record a new message or change an old one.
- 2 Press ✓ again and follow the on screen instructions. When you finish recording remember to press ✓ to stop recording. If you go over the 10 second recording time (indicated by a beep) just repeat the recording procedure again taking care not to go over the 10 second time limit. The recording is complete.

Test report

This menu allows you to test the telephone reporting feature.

- Please check with the call recipients before making a test call.
- Ensure that the phone cord is connected.

- 1 Select Test report and press ✓.

- 2 A list of numbers will be displayed, select the number you want to test and press ✓.

- 3 The control unit will now display call progress.

- The address message and pre-recorded emergency, burglar and acknowledgement request messages will be played in a loop for 85 seconds.
- The test can be cancelled at any time by either pressing the ⏪ button or the call recipient pressing “9” on their phone to acknowledge the call. If a radio DECT or mobile phone is used, remember to press 9 repeatedly until the call closes.
- Check that the call has been successfully received.

6 Using the System

Arm and disarm the system and practice using it. Trigger the alarm by arming the system and opening protected door/windows and walking past PIRs. Now is the time to show the rest of the family how simple it is to use.

i The PIRs have a built-in sleep timer to save battery power. If there is no movement in front of the PIRs for 1 minute, the PIRs will become 'ready to signal' and movement will now be reported. The PIRs will sleep for 1 minute after reporting.

Any movement detected in sleep time will not be reported and will extend the sleep period by a further 1 minute.

Away Arm

Arming the System

- 1 When the system is disarmed (alarm off), press the arm key on the control unit, keypad or keyfob.
- 2 The control unit will start its countdown.
- 3 When the exit delay time is up, the control unit will sound a long beep. The siren will beep once and the strobe will flash once after the exit delay has expired. 'Alarm on' will be displayed on the screen and the system is now in away armed.
- 4 If there are faults within the system, i.e. the tamper switch of a sensor left opened, the user will not be able to arm the system with a single press. The user can use the control panel, keypad and keyfob to force arm the system by pressing arm twice.

Stopping the Exit Delay by Disarming

- 1 Press the disarm key on the keyfob or press the disarm key followed by a PIN code on the control unit and keypad.
- 2 'Alarm off' will be displayed on the screen and the system will return to disarmed mode.

Extending the Exit Delay

- The exit delay time can be extended during the exit delay period by pressing the arm button on the keypad or keyfob. Each time the arm button is pressed, the delay time starts counting from the beginning.

Alarm Activation

- If any Door/Window contact or PIR sensor set to entry or away entry is triggered, the entry timer will be started. If the entry timer is allowed to expire and alarm will be activated.
- If other sensors not set to entry or away entry is triggered, the alarm will be activated immediately.

Disarm

Disarming the System

- 1 Press the disarm key on the keyfob or press the disarm key followed by a PIN code on the control unit and keypad.
 - The keyfob only will only disarm the system during entry time after an entry or away entry door/window contact or PIR has been triggered.
- 2 The control unit will sound a long beep. The siren will beep twice and the strobe will flash side to side. 'Alarm off' will be displayed on the screen and the system is now disarmed.
- 3 The control panel will lock out for 5 minutes if the pincodes had been entered incorrectly for five times.

Home Arm

The home mode allows the home to be partially armed so that no one can get inside without first disarming the system. However, the person inside the house can move freely around without triggering the alarm. Home mode is usually used to protect the ground floor when you are upstairs in bed.

Arming in Home Mode

- 1 When the system is disarmed (Alarm off), press the home arm key on the control unit, keypad or keyfob.
- 2 The control unit will start its countdown.
- 3 When the exit delay time is up, the control unit will sound three short beeps. The siren will beep once and the strobe will flash once after the exit delay has expired. 'Home' will be displayed on the screen and the system is now in home armed.
- 4 If there are faults within the system, i.e. the tamper switch of a sensor left opened, the user will not be able to arm the system with a single press. The user can use the control panel, keypad and keyfob to force arm the system by pressing arm twice.

Extending the Exit Delay

- The exit delay period can be extended in a similar manner as described in Away Arm.

Alarm Activation

- If any door/window contact or PIR sensor set to entry is triggered, the entry timer will be started. If the entry timer is allowed to expire and alarm will be activated.
- Home omit and away entry sensors will be ignored.
- If other sensors not set to home omit, entry

or away entry are triggered, the alarm will be activated immediately.

Stop the Alarm and Alarm Display

During an alarm, the control panel and outside siren will sound and dial the emergency phone number. The control unit will display "ALARM! ALARM!" to notify the user.

Stopping the Alarm

- 1** Press the disarm key and enter a user code on the control unit or keypad. The control unit will sound a long beep and display the device that caused the alarm. The siren will beep twice and the strobe will flash side to side.
 - The keyfob cannot stop an alarm caused by burglar or emergency device.
- 2** When the control unit is displaying the source of the alarm, pressing any key will display the telephone number that it dialled out and acknowledged (if any). If there were more than 2 numbers that were acknowledged the numbers will be shown by pressing further keys.
- 3** When "Alarm off" is displayed the system is disarmed.

Alarm Memory

- If an alarm was raised during your absence, and the alarm sequence has been carried out, the screen will continuously show "ALARM! ALARM!".
 - Disarm the system as normal and the siren will give 3-second alarm sound instead of the normal two beeps to indicate that there might still be an intruder still in the house.
 - To clear the display, follow the same steps as 'Stopping the Alarm' described above.
-

Dialling & Call Acknowledgement

Auto Dialling

- If the system is in away arm mode, when an alarm occurs the control unit will immediately dial the preset phone numbers.
- If the system is in home mode or disarmed mode when an audible alarm is initiated, the control unit will wait for 15 seconds before dialling the preset phone numbers.
- After dialling, the control panel will wait 5 seconds then playback the messages in a loop. It will first

play the recorded address message then the pre-recorded messages (Burglar, Emergency) depending on the nature of the alarm and finally an acknowledgement request message.

- The recipient should acknowledge the message by pressing '9' on their telephone when prompted.
- Recipients using radio DECT phones or mobiles should press the numbers repeatedly until the call is closed.
- If the control unit does not receive an acknowledgement, the messages will be repeated for a period of 80 seconds before attempting to dial again. Each number will have 5 call attempts.
- The control panel will continue to dial the number(s) until a call is successfully answered with a '9' acknowledgement.
- System auto-dialling features only operate under tone-dialling method.
- When no telephone number is stored, the control panel will not dial out.

Remote Access

The control unit allows you to control your system remotely through the telephone line.

- 1** Dial the phone number associated with the Control panel.
- 2** Hang up on the first ring.
- 3** Wait 5-10 seconds.
- 4** Dial the number again.
- 5** The control unit will answer the phone on the first ring of that second call.
- 6** Enter your PIN Code within 3 seconds.
- 7** If the PIN code is correct, you will hear a long beep. A list of different functions is detailed below:

Press 2 Put the system into away armed mode (arm the system).

Press 3 Disarm the system.

Press 5 Checking the system status. Long single beep for Away Armed, two beeps for Disarmed and three beeps for Home Armed.

Press 7 Siren on.

Press 8 Siren off.

Press 9 or 0 Disconnect.

- Remember to press 9 or 0 before you hang up, or the control unit will hang up automatically after 30 seconds.

i Disabling the system tamper

Before mounting it is important to disable the siren and system tamper to avoid the siren sounding an alarm.

- 1** Press the **Menu** key and enter a user PIN code followed by ✓.
- 2** The control unit is now in programming mode, Select Devices, then Program Siren and Siren Tamp. Off using the ▲▼✓ keys.
- 3** Press ✓ when in the Siren Tamp. Off menu and the control unit will beep followed by an acknowledgement pip from the siren.
 - *Siren programming is described more fully in "Control Panel Menu System in Detail" in section 5.*
 - *The siren tamper will now be disabled for 1 hour after which it will automatically arm again. If longer is needed to fit the siren then simply repeat the steps above.*
 - **Leave the control unit in programming mode to stop the system responding to tampers. If the control unit automatically times out, re-enter programming mode again.**

i Enabling the system tamper

After mounting the siren and detectors, please enable the system tamper by:

- 1** Press the **menu** key and enter a user PIN code followed by ✓.
- 2** The control unit is now in programming mode, Select Devices, then Program Siren and Siren Tamp. On using the ▲▼✓ keys.
- 3** Press ✓ when in the Siren Tamp. On menu and the control unit will beep followed by an acknowledgement pip from the siren.
- 4** Quit programming mode and system tamper protection will be automatically restored.

Adding and using Accessories

To provide additional protection you can add extra door/window contacts, PIRs, keyfob remote controls, keypad remote controls, help buttons and smoke detectors. These are available separately from your local stockist.

Preparation

See section 2 for battery insertion, activation and part identification. See also section 1 and section 4 for installation details and suggestions.

Adding accessories to your system

- 1 From the programming menu of the control unit, select the 'Devices' and press ✓, select 'Add Device' and press ✓ again.
- 2 Press the Learn button on the device when prompted and confirm it is the correct detector by pressing ✓.

Learn buttons (see Chapter 2 for location):

- Keyfob: Press arm
- PIR: Press the test button
- Door/Window contact: Press the test button
- Help button: Press the emergency button
- Smoke detector: Press the test button
- Keypad: Press 8+9 together. The keypad needs initialising first, see keypad section on the right.

- 3 Depending on the device learnt in, finish the programming as prompted.

Using your keyfob

- The keyfob can be used to Away Arm, Home Arm, and Disarm the system using the buttons as shown.
- An emergency alarm can be activated by pressing the emergency button for 3 seconds until LED stops flashing.
- An emergency alarm can only be stopped by using the control unit keypad or a remote keypad.
- The system can only be disarmed after an entry or away entry sensor is activated (in the entry period).

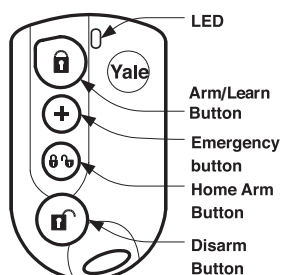

Keypad

Keypad initialisation

If you purchase a keypad as an accessory, you will need to initialise it prior to use with the control panel.

- 1 Press the 'Panic button A' key followed by factory default keypad code '0000' (this is different to your control panel pincode).
- 2 The LED will now flash slowly indicating it is in test (programming) mode.
- 3 Press the 'Panic button A' key followed by the '7' key to set the keypad into Control panel system mode (also known as slave mode).
- 4 Quit test mode by pressing the disarm key twice. The keypad code and mode setting has been completed. The Keypad will now use the same pincode that is set for the control panel unit.

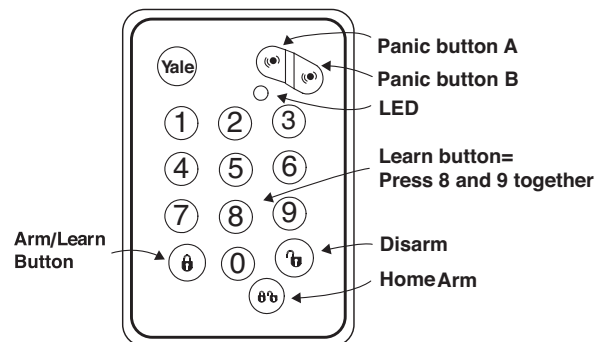

Forgotten keypad code (different to control panel pincode)

If the keypad code is accidentally forgotten, the keypad can be reset to factory default (0000) using the following steps:

- 1 Unscrew the two keypad case screws and remove keypad back cover (please disable tamper first). Locate and remove the battery.
- 2 Press the number '4' key at the same time as reinserting the battery.
- 3 Screw the keypad case together and re-learn the keypad into the system using the steps described above in this section.

Using your keypad

- The keypad can be used to Away Arm and Home Arm the system using the buttons as shown.
- The system is disarmed by pressing the disarm button followed by any user code, similar to using the control unit keypad.
- An emergency alarm can be activated by pressing the panic A and B buttons simultaneously. Deactivate you panic event by pressing disarm button followed by any user code.
- The keypad uses the same user pincodes programmed into the control unit for disarming.
- To extend the exit time, press the arm or home arm button once more on the keypad.
- If there is a system fault. you will need to press the arm/home arm button for a second time to “force arm” the system.

Using your smoke detector

Smoke Detection

When smoke is detected the device will activate for a minimum of 10 seconds with a two tone alarm and flashing LED for a local fire alarm. The detector will send a radio signal to the control unit for activating a system fire alarm.

- Pressing the test button when in an alarm condition will silence the alarm for 10 minutes. It will automatically resume smoke detection again after this period.
- If the smoke density is still over the alarm threshold, then the smoke detector will remain in an alarm condition and it will repeat the local fire alarm with a radio fire alarm signal to the control unit.

Testing

- Smoke detector testing should be done on a regular monthly basis. Pressing the test button will make the LED flash, the audible sounder chime and will send a radio test signal to the control unit when the button is released. If nothing happens after pressing the test button, it indicates the batteries will need changing.

Recalibration

- The smoke detector might need recalibrating after time to ensure it is working at its optimum. This is done by pressing and holding the test button until the LED flashes and beeps after 10 seconds. The detector will then start its self calibration routine.

Using your Help Button

Activate an Alarm

- Press and hold the red button for at least 3 seconds. The LED will light momentarily and the alarm will be activated.

Silence an Alarm

- Press and hold down the red button for 10 seconds. The LED will light momentarily for a second time and the alarm will be silenced.
- Please note that silencing the alarm with the help button does not reset the system. If the alarm is armed prior to activation, the system will re-arm after being silenced with the help button.
- The system will require a reset at the control unit after being silenced with the help button.

Changing the Batteries

Always use alkaline batteries or the correct type of coin cells as replacements because any other battery can cause problems with the operation of the system. Typical life of batteries is two years or more. Ensure the correct steps are taken when changing batteries in tamper protected devices.

Control unit low battery Indication

The control unit will display all device low battery conditions with the exception of the siren. This is shown by a fault display with the fault LED lit on the front panel. In addition the devices also can show low battery conditions as described below. When a device first shows low battery signal it has enough battery capacity to operate for a further month before complete exhaustion.

Siren battery change

When the batteries start getting low the siren will produce a series of pips and flashes during arming and disarming.

- 1 Switch off tamper protection at the control unit as described in the end of section 6.
- 2 Remove the siren lid and switch the siren power switch to OFF.
- 3 Unscrew the four screws on the battery compartment lid and remove the cover.
- 4 Remove the four batteries, wait for 30 seconds, and replace them with four fresh alkaline "D" cells.
- 5 Switch on siren power and check that the siren beeps and flashes.

Warning: After the batteries have been inserted, the tamper will become active after three hours. Please replace the cover back onto the siren quickly.

- 6 Replace battery compartment lid and screws and reattach siren lid. Siren tamper protection will be automatically enabled after 3 hours.
- Siren case tamper conditions are also signalled by a series of beeps when the system is armed but not when the system is disarmed (low battery warning produces a series of pips when armed and disarmed), take care not to confuse the two different conditions.

PIR battery change

When the battery is low the LED will flash when any movement is detected. The batteries are changed as follows:

- 1 Put control unit into programming mode to prevent a tamper alarm.
 - 2 Loosen the case screw and remove PIR sensor from base to reveal three AAA batteries.
 - 3 Insert new alkaline batteries observing correct polarity. The PIR LED will flash for 30 seconds while initialising.
 - 4 Refit sensor on base and tighten bottom case screw. Switch tamper protection back on.
- PIR case tamper conditions are also indicated by a flashing LED, check the tamper before changing the batteries.

Door/Window Sensor battery change

When the battery is low the LED will light up when the door/window is opened. The battery is changed as follows:

- 1 Put control unit into programming mode to prevent a tamper alarm.
 - 2 Loosen the case screw and remove door/window sensor from base to reveal battery.
 - 3 Using a screwdriver gently lever out the old battery.
 - 4 Insert new CR2032 coin cell with the + side uppermost.
 - 5 Press battery into holder firmly with finger and thumb until a click is heard.
 - 6 Refit sensor on base and tighten bottom case screw. Switch tamper protection back on.
- Door/window sensor case tamper conditions are also indicated by a lit LED, check the tamper before changing the battery.

Keyfob battery change

When the battery is low the LED will glow dimly when any key is pressed. The battery is changed as follows:

- 1 Using a coin turn the battery cover anticlockwise to the unlocked position and remove cover and battery.
- 2 Insert new CR2032 coin cell with the + side uppermost.
- 3 Replace battery cover.

Press any key and check that the LED lights. If the LED lights the new battery installation is successful.

Keypad battery change

When the battery is low the LED will flash when any key is pressed. The battery is changed as follows:

- 1 Put control unit into programming mode to prevent a tamper alarm.
- 2 Unscrew the two keypad case screws and remove keypad back to reveal battery.
- 3 Using a screwdriver gently lever out the old battery.
- 4 Insert new CR2032 coin cell with the + side uppermost.
- 5 Press battery into holder firmly with finger and thumb until a click is heard.
- 6 Press a number key and check that the LED lights. If the LED lights the new battery installation is successful, screw keypad back on and the battery change is complete.

Help button battery change

When the battery is low the LED will glow dimly when the button is pressed. The battery is changed as follows:

- 1 Loosen the bottom case screw and take button cover off base.
- 2 Insert new 12V 23A/MN21 alkaline miniature 'lighter battery', taking care to observe polarity (see Section 2).
- 3 Replace button cover.

Press the button and check that the LED lights. If the LED lights the new battery installation is successful.

Smoke detector battery change

When the battery is low the LED will flash accompanied with a Low-volume beep once every 30 seconds.

- 1 Rotate smoke detector anti-clockwise to detach from base bayonet fixing.
- 2 Insert new AA alkaline batteries, taking care to observe polarity and wait 15-20 minutes for the smoke detector to recalibrate itself, indicated by a rapidly flashing LED..
- 3 Replace smoke detector on base and rotate clockwise to lock.
- 4 Press the test button and check that the LED lights and the sounder chimes.

Troubleshooting

For online assistance, please visit: www.Yale.co.uk

Siren

Siren does not respond to arming or disarming

- Siren batteries are completely exhausted. Check siren batteries by removing siren cover, if there is no tamper alarm when removed, replace batteries with new alkaline equivalents.
- Siren not learnt-in. If siren produces a tamper alarm when the cover is removed and siren is OK, learn-in the siren.
- Siren out of range.

Siren produces a 3 second alarm when disarmed

- There has been a previous alarm and there might be an intruder still in the premises.

Siren produces a series of pips when armed or disarmed

- The siren has low batteries. Check that the siren produces a series of pips when arming and disarming, indicating low batteries. Change batteries with new alkaline replacements.
- The siren tamper switch has been disturbed. Check that the siren produces a series of pips only when arming, indicating a tamper fault. Check that the siren cover is firmly secured and the tamper switch plunger is in contact with the wall. If not use suitable packing material to fill gap.

Siren produces an interrupted tone when sounding an alarm

- The siren has low batteries. Change batteries with new alkaline replacements.

PIR

PIR does not respond to movement

- Previous movement has triggered the PIR sleep timer and is preventing subsequent movement detection. Arm system and vacate protected room for at least 1.5 minutes before testing.

PIR is slow to respond

- This is normal, the PIR has sophisticated false alarm filtering that will filter out random fluctuations and responds to genuine movement across field of view, it is less sensitive walking directly towards it.

PIR gives false alarms

- Check pets have no access to protected area.
- Check that PIR is not pointed at sources of heat or moving objects, e.g. fluttering curtains.

- Check that PIR is not mounted above convector heaters or pointing directly at windows.

PIR LED flashes

- Batteries are low or the tamper switch is disturbed. Check that the tamper switch spring is making contact with base. If the tamper switch is OK, change batteries with new alkaline replacements.

PIR does not respond to movement

- Batteries are completely exhausted. Change batteries with new alkaline replacements, LED will flash for 30 seconds while components initialise.

Door contact

Door contact LED lights up

- Batteries are low or the tamper switch disturbed. Check that the tamper switch spring is making contact with the mounting surface. If the tamper switch is OK, change batteries with new CR2032 coin cell replacements.

Door contact does not respond to door opening when jumper is in test position

- Batteries are completely exhausted. Change batteries with new CR2032 coin cell replacements.
- The magnet is too far away from the door contact. Check that the gap between door contact and magnet is not greater than 8mm.

Control unit

User PIN code is not accepted by the control unit.

- Do not pause for more than 5 seconds in between pressing the keys on the keypad.
- Incorrect code entered. Re-enter the correct PIN code.
- Reset settings - see 'Reset Procedure' and reprogram the system.

Voice - Dialler not responding to alarm

- Check the telephone line is connected and that the correct telephone numbers have been programmed.

RED triangle LED illuminates and warning beeps (every 30 seconds if enabled)

- There is a fault condition in your alarm system.
Note: this may be a simple fault that can easily be rectified, for example replacing low batteries in an internal PIR (movement) sensor.
- Please view the 'fault log' in the control panel to determine what the issue is. This is the first option in the programming menu. First press the 'menu' key and enter your user PIN code followed by pressing ✓. Select 'fault log' followed by ✓. You may need to scroll down using the ▼ Key to check if there are multiple faults in the system. As an example, the display may read 'DC Z01 tamper', in which case you need to check the mounting of the tamper spring on door contact zone 01 to rectify this fault. In this case of low batteries, you may see 'IR Z02 LB'. Replacing the batteries in PIR zone 02 will clear this particular fault. Other reported faults include: Interference, Tamper, Radio Device Low Battery and AC Power Fail etc.
- If faults have not been cleared from the 'fault log', a fault display will be shown when the Arm or Home Arm keys are pressed, with the device and fault that is causing the problem.
- If more than one fault is present then individual fault messages will be displayed sequentially at 2-second intervals.

IMPORTANT:

Please enter the programming menu first before swapping out batteries- otherwise you will trip the system tamper alarm.

Press the 'menu' key and enter your user Pincode followed by pressing ✓. Stay in the programming menu. Then, disconnect the relevant sensor and replace batteries. If the control panel times out and returns to 'Alarm off', please follow the above steps again and repeat the process.

Complete Reset Procedure

Reset to factory default setting

The control panel can clear all programmed parameters by the following sequence:

- 1 Power down control panel and remove the battery.
- 2 Apply power while holding down the ▲ key.
- 3 Release the ▲ key when a tone is heard, 'Enter Code' will be displayed.
- 4 Enter the following key sequence:
▲▼▲▼▲▼▲▼✓
- 5 Press the ⌂ key.
- 6 All programmed parameters are reset to factory default setting.
- 7 If more than 17 incorrect keys are entered, then the unit will revert to normal Alarm On mode.

Note

- Once the 'System Reset' is executed, all the programmed data is returned to its default value and all the programmed devices will be removed. User will be prompted with the initial setup screen. Press the learn button (see Chapter 2 for location) on all accessories one at a time. Every time a button is pressed, the screen will prompt the device and you will need to press OK on the panel to acknowledge/add. Please ensure you learn in all devices before exiting the initial setup screen.

Partial Reset Procedure

Reset to factory default setting however keeping memory of all learnt sensors.

The control panel can clear all programmed parameters by the following sequence:

- 1 Power down control panel and remove the battery.
- 2 Apply power while holding down the ▲ key.
- 3 Release the ▲ key when a tone is heard, 'Enter Code' will be displayed.
- 4 Enter the following key sequence:
▲▼▲▼✓

5 Press the **⏪** key.

6 All programmed parameters are reset to factory default setting. All learnt sensors will be kept.

7 If more than 17 incorrect keys are entered, then the unit will revert to normal Alarm On mode.

Jamming/Interference detection

User can enable Jamming/interference detection should they feel it is a risk.

Detection via control panel

From the panel's menu system, select:
Adv. Setting -> Jamming Det, Enable.

Detection via External Siren

Open up the siren (Disable tamper first, see earlier section) and switch the Dip Switch 2 to On position.

* Enabling these features increases the likely hood of false alarm (false positive scenario).

Alarm sensor response table

	Disarm	Away Arm	Home Arm	Exit	Away Arm Entry	Home Arm Entry
Burglar	No action	Instant Burglar alarm	Instant Burglar alarm	No action	No action	No action
Home Omit	No action	Instant Burglar alarm	No action	No action	No action	No action
Entry	Door Chime	Start Entry Timer	Start Entry Timer	No action	No action	No action
Away Entry	Door Chime	Start Entry Time	No action	No action	No action	No action
24 Hour	Instant Burglar Alarm	Instant Burglar Alarm	Instant Burglar Alarm	Instant Burglar Alarm	Instant Burglar Alarm	Instant Burglar Alarm

Specifications

All devices

Environmental conditions

-10°C to 40°C, relative humidity 70% non-condensing for all units except the external siren. Siren: -20°C to 50°C, relative humidity 95% non-condensing

Radio operational range

30m in a typical domestic installation, range can vary depending on building construction, device positions and RF environment

Housings ABS/polycarbonate

Control unit

Display Backlit 2 x16 character LCD

Keypad 18 keys (Touch/Physical)

Siren Output 100dBA sound pressure @ 1m minimum

Zones 20 radio devices

Radio system 868MHz FM

Power supply Plug top adaptor type, input 230VAC 50Hz, output 12VDC, 1A, tested to EN 60 950

Rechargeable battery Ni-MH, 7.2V 600mah, charge time 30hrs, standby time 10hrs

Telephone interface Tested to TBR 21.
REN rating 1

Siren

Siren output 104dBA sound pressure @ 1m minimum

Radio 868MHz FM

Power supply 6V, 4 x D alkaline cells. 2.5 years typical service life

Passive infra red (PIR) Detector

Alarm processing Microprocessor controlled dual edge sequential pulse count with pulse length discrimination

Radio 868MHz FM

Power supply 4.5V, 3 x AAA alkaline cells. 2 years typical domestic service life without supervision.

Movement detection range 12m, 110°

Door/window contact

Radio 868MHz FM

Power supply 3V, CR2032 lithium coin cell. 2 years typical domestic service life without supervision.

Smoke detector

Radio 868MHz FM

Power supply 4.5V, 3 x AA alkaline cells. 3 years typical domestic service life

Tested to EN54

Keyfob remote control

Radio 868MHz FM

Power supply 3V, CR2032 lithium coin cell. 3 years typical domestic service life

Keypad remote control

Radio 868MHz FM

Power supply 3V, CR2032 lithium coin cell. 3 years typical domestic service life

Help button

Radio 868MHz FM

Power supply 3V, CR2032 lithium coin cell. 3 years typical domestic service life

ASSA ABLOY Ltd.
School Street, Willenhall
West Midlands
England, WV13 3PW

EC Declaration of Conformity

We: ASSA ABLOY Ltd.
School Street
Willenhall
West Midlands
England
WV13 3PW

declare under our sole responsibility that the following product(s):

Model: EF-KIT1
EF-KIT2
EF-DC
EF-PIR
EF-PETPIR
EF-KF
EF-KP
EF-BX
EF-SD
EF-PB
EF-PANEL

is (are) in conformity with the following relevant harmonised standards:

EN 300 220-1 / V2.3.1 (2010)
EN 300 220-2 / V2.3.1 (2010)
EN 301 489 -1 / V1.8.1 (2008)
EN 301 489-3 / V 1.4.1 (2002)
EN 60 950-1 / 2006 + A11 : 2009 + A1: 2010 + A12:2011

following the provisions of Council Directive 1999/5/EC on radio equipment and telecommunications terminal equipment and the mutual recognition of their conformity,

Name: John Ward

Position: Director

Signature: 

Date: 03/09/12

On behalf of ASSA ABLOY Ltd.

Installation Notes:





2 Year Guarantee Statement

This product is guaranteed for consumers against faulty workmanship, materials and function for a period of 2 years from the date of purchase providing the full installation and maintenance instructions are followed. Please keep your proof of purchase safe, this must be submitted when making a claim under this guarantee.

Please note that it is a condition of this guarantee that your Yale product:

- Has been correctly installed and maintained in accordance with the Yale installation and maintenance instructions provided to you at the time of purchase.
- Has not been modified or damaged in any way.
- Has not been subjected to unauthorized repairs.

Yale are responsible under this guarantee for repairing the product or replacing the product as we deem necessary. If there is fault with the product, please contact Customer Services on 01902 364647, who will give you the name of an expert and confirm what you need to do to make a claim under this guarantee.

Please do not carry out any repairs without our authority or by using an unauthorised expert. Any repairs or other works carried out without our authorization or by using an unauthorized expert will not be covered under this guarantee.

This guarantee is non transferrable and applies to products purchased in the United Kingdom only. This guarantee does not apply to normal wear and tear. This does not affect your statutory rights. A full copy of this guarantee is available upon request by writing to Yale UK, School Street, Willenhall, West Midlands. WV13 3PW or by visiting our website www.yale.co.uk.



WEEE

Note: Waste electrical products and batteries should not be disposed of with household waste. Please recycle where facilities exist. Check with your local authority or retailer for recycling advice.



E2 09\12

THE YALE BRAND, with its unparalleled global reach and range of products, reassures more people in more countries than any other consumer locking solution.

THE ASSA ABLOY GROUP is the world's leading manufacturer and supplier of locking solutions, dedicated to satisfying end-user needs for security, safety and convenience.