

Installation Manual

Premier Elite 24/24-W/48/48-W/88/168 & 640

Revision 9



INS176

Texecom
Designed to Perform

Contents

Contents	2	Trouble-Shooting	42
1. System Overview	4	Reset and Service Messages	44
System Architecture	4	5. Programming the Control Panel	45
Control Panel	4	Introduction	45
Remote Keypads	5	Copying and Pasting	47
Zone Expanders	6	Log Off Engineer	47
Output Expanders	6	Resetting the Engineers Code (User 00)	47
Communicators	6	5.1 Zone Setup	48
Other Devices	6	Ricochet Devices MT2	49
3. Installation	7	Zone Types	50
Installation Sequence	7	Zone Attributes 1	51
Control Panel	7	Zone Attributes 2	51
Power Supply Ratings	18	Attributes for Moment or Latch Keys	52
Connecting AC Mains	19	Attributes for Custom Zones	52
Connecting Batteries	19	Zone Areas 24/48/88/168	52
Connecting Devices to the Network	20	Zone Areas 640	52
Remote Keypads	22	Zone Text	52
8XP-W & 32XP-W V2.xx>	23	Zone Chime	52
System Design Considerations	23	Remote Test Enable	53
Ricochet MT2 Expander Addressing	24	Zone Wiring	53
8XE Zone Expander (24 Only)	25	Zone Groups	53
8XP Zone Expander	25	DD 243	53
Star and Daisy Jumper Option	26	5.2 Area Programming	54
iProx Module	27	Timers	54
60iXD Zone Expander	27	Arming Modes	55
OP16 Output Expander	27	Area Arm Suites 24/48/88/168	55
RM8 Relay Module	28	Area Arm Suites 640	56
Zone and Output Numbering 24/48/88/168	29	Area Suite Text	56
Zone and Output Numbering 640	30	Suite Arm Modes	57
Zone Connections	31	Area Options 24/48/88/168	57
60iXD Zone Expander	32	Area Options 640	57
Auxiliary/Fault Connections	33	Time Arm Area	61
Speaker Connections	33	Area Text	61
External Sounder Connections	33	5.3 Global Options	62
Panel Outputs	34	System Timers	62
Digicom Outputs 1 - 8	34	System Config	63
2-Wire Smoke Detector	35	System Options	67
Expander Auxiliary Input	35	Monitor Hardware	68
Plug-on Communicators	36	Control Timers	68
Com GSM	36	System Text	69
SIM Card Types	37	Part Arm Text	69
Premier Elite ComGSM Layout	37	Holiday Dates	70
Aerial Siting	38	Speaker Tones	70
Installation	38	PC Output Text	71
Panel Configuration	38	Custom O/P Text	71
Using the SMS Control Commands	38	5.4 Keypad Setup	72
What will be sent in the Text Message	39	Keypad Areas	73
AV Module	40	Keypad Zone Mapping	73
ComIP Module	40	Keypad Options	73
Commissioning	41	Keypad Speaker Volume	73
USB-Com	41	Keypad Sounder Options	73
PC-Com	41	5.5 Expander Setup	74
PRINT-Com	41	Expander Areas	75
Connecting a Computer	41	Expander Location Text	75
Connecting a Printer	41	Expander Auxiliary Input	75
4. Commissioning and Troubleshooting	42		
Commissioning	42		

Expander Speaker Volume	75	Change Eng. Code	119
Expander Sounder Options	75	Adjust Volumes	119
5.6 System Outputs	76	Default NVM Data	119
Available Outputs	77	Location Text	119
Programming Outputs	77	Print Log Data	120
Output Group - Not Used	77	Soak Test Areas 24/48/88/168	120
Output Group - System	77	Soak Test Areas 640	120
Output Group - Area	79	View ID Data	121
Output Group - Zone	81	Configure Radio	121
Output Group - User Code Entered	81	Ricochet Diagnostics (MT2 Only)	122
Output Group - Control Timer	81	5.10 Programming Part Arms	124
Output Group - PC Control	81	Alter Part Arms	124
Output Group - Door Control	81	6. Specifications Control Panels	125
Output Attributes	81	Remote Keypads	128
X-10 Outputs	81	Zone Expanders	128
Custom Outputs	82	Output Expanders	128
Zone Group Outputs	82	Standards	129
5.7 UDL/Digi Options	83	Warranty	129
Reset Digi	83	Notes:	130
Start Test Call	83	Notes	131
MSN/Pre-Dial No.	83		
Program Digi	84		
Digi Options	88		
Area Accounts 24/48/88/168	88		
Area Accounts 640	89		
UDL Options	90		
Setup Modules	92		
Com Port Setup	94		
DualCom® Inside (48 Only)	95		
EMIZON 21 TCD	96		
WebWayOne	97		
Chiron IRIS	99		
Zone Alarm Reporting Codes	100		
5.8 Setup Users	107		
Default User Codes	108		
Programming New Users	108		
User Types	108		
User Functions and Options	109		
User Options 1	110		
User Options 2	110		
User Config	110		
User Time Lock	110		
User Name Text	111		
Door Control	111		
Adding Tags	111		
Deleting Users	111		
Adding SmartKey™	111		
5.9 Engineer Utilities	112		
View Event Log	112		
Do Bell Test	115		
Do Walk Test 24/48/88/168	115		
Do Walk Test 640	116		
View Zone Status	116		
Do System Tests	117		
Confirm Devices	117		
View RKP Status	118		
View Exp. Status	118		
Set System Time	118		
Set System Date	118		

1. System Overview

System Architecture

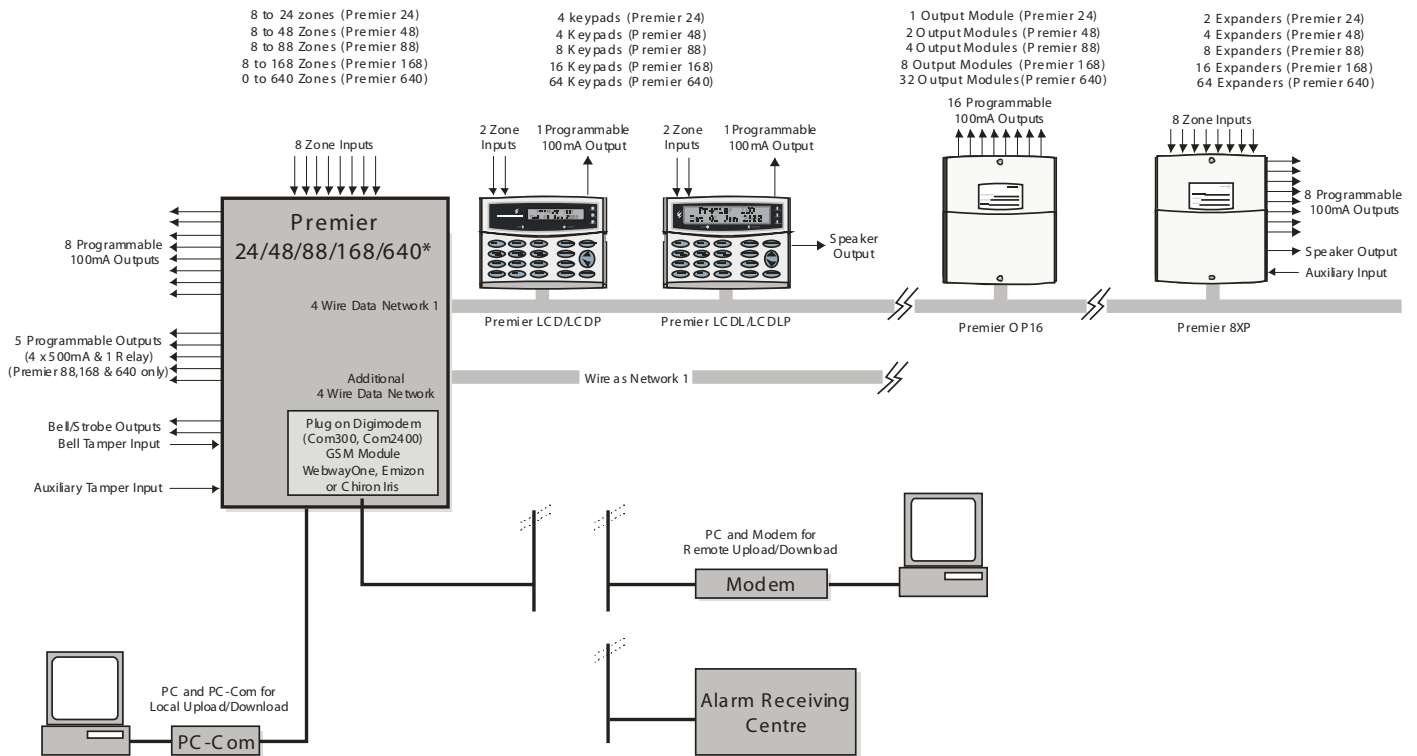

* No Onboard Zones

Control Panel

Premier Elite 24

- 8 fully programmable Double Pole or End Of Line zones
- Expandable to 24 zones via keypads and zone expanders
- 1 x 4-wire data network (standard 7/0.2 alarm cable)
- Up to 4 keypads and 2 zone expanders
- Up to 1 output module
- 2 independent areas each with 3 part arms
- 2 area arm suites
- 25 programmable User codes
- 500 Event Log (time & date stamped)
- 1 programmable panel outputs (1 x 100mA)
- 1.5 Amp power supply (plastic Case)

Premier Elite 48

- 8 fully programmable Double Pole or End Of Line zones
- Expandable to 48 zones via keypads and zone expanders
- 1 x 4-wire data network (standard 7/0.2 alarm cable)
- Up to 4 keypads and 4 zone expanders
- Up to 2 output modules
- 4 independent areas each with 3 part arms
- 4 area arm suites
- 50 programmable User codes
- 500 Event Log (time & date stamped)
- 2 programmable panel outputs (2 x 1A)
- 2.5 Amp power supply

Premier Elite 24-W & 48-W

- 4 Onboard Zones
- 8 wireless device **Ricochet™** enabled receiver onboard (24-W)
- 32 wireless device **Ricochet™** enabled receiver onboard (48-W)
- Expandable to 24/48 zones via keypads and zone expanders
- 1 x 4-wire data network (standard 7/0.2 alarm cable)
- Up to 4 keypads and 2/3 zone expanders
- Up to 2 output modules
- 2 or 4 independent areas each with 3 part arms
- 2 or 4 area arm suites
- 25 or 50 programmable User codes
- 500 Event Log (time & date stamped)
- 1 or 2 programmable panel outputs (2 x 500mA)
- 1.5 Amp power supply

Premier Elite 88

- 8 fully programmable Double Pole or End Of Line zones
- Expandable to 88 zones via keypads and zone expanders
- 1 x 4-wire data network (standard 7/0.2 alarm cable)
- Up to 8 keypads and 8 zone expanders
- Up to 4 output modules
- 8 independent areas each with 3 part arms
- 8 area arm suites
- 100 programmable User codes
- 1000 Event Log (time & date stamped)
- 5 programmable panel outputs (4 x 1A & 3A relay)

- 2.5 Amp power supply

Premier Elite 168

- 8 fully programmable Double Pole or End Of Line zones
- Expandable to 168 zones via keypads and zone expanders
- 2 x 4-wire data network (standard 7/0.2 alarm cable)
- Up to 16 keypads and 16 zone expanders (8 per network)
- Up to 8 output modules (4 per network)
- 16 independent areas each with 3 part arms
- 16 area arm suites
- 200 programmable User codes
- 2000 Event Log (time & date stamped)
- 5 programmable panel outputs (4 x 1A & 3A relay)
- 2.5 Amp power supply

Premier Elite 640

- 0 fully programmable Double Pole or End Of Line zones
- Expandable to 640 zones via keypads and zone expanders
- 8 x 4-wire data network (standard 7/0.2 alarm cable)
- Up to 64 keypads and 64 zone expanders (8 per network)
- Up to 64 output modules (8 per network)
- 64 independent areas each with 3 part arms
- 64 area arm suites
- 500 programmable User codes
- 5000 Event Log (time & date stamped)
- 5 programmable panel outputs (4 x 1A & 3A relay)
- 2.5 Amp power supply

Premier Elite 24, 24-W, 48, 48-W, 88, 168 & 640

- 32 Event Alarm Log
- 500 Event Mandatory Log
- 8 programmable digicom outputs (100mA each)
- 32 character zone text
- Facility for Plug-on Digimodem (*Com300/2400/*)
- Facility for Plug-on IP Module (*ComIP/Chiron/WebWayOne/Emizon*)
- Facility for a plug-on RedCARE/RM8 Relay Module (Not Premier 24)
- PC-Com/printer port

Remote Keypads

LCD

- 32 character text display
- 2 fully programmable DP or EOL zones
- 1 fully programmable output (100mA -ve applied)
- Fully adjustable back-lighting, normally bright, dim or off, changing to bright during entry or following a key press
- Built in piezo sounder
- Programmable 'Info.' LED

LCDL

ALL the features of the LCD plus:

- Larger 32 character text display
- Speaker output

LCDP

- LCD with a built in Proximity Tag Reader

LCDLP

- LCDL with a built in Proximity Tag Reader

FMK/SMK

- LCDLP Metal Flush or Surface Mount
- Various finishes available

RKP8/16Plus

- LED Arming keypad
- 2 fully programmable EOL zones
- CANNOT be used for Programming

Icon Guide

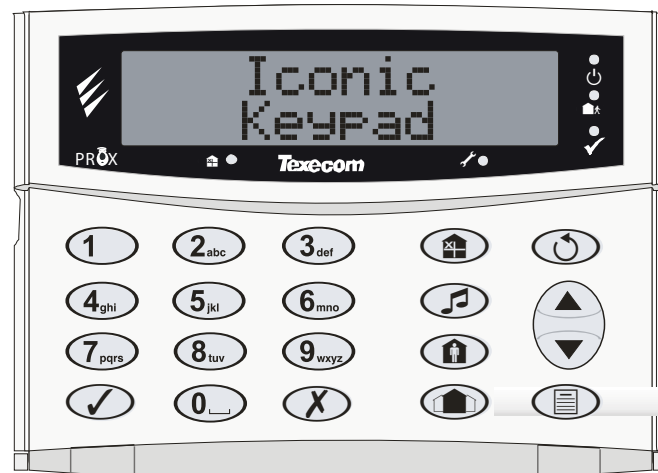

Keys

ICONS	=	UK English	=	English
	=	Omit	=	Bypass
	=	Chime	=	Chime
	=	Part	=	Stay
	=	Area	=	Area
	=	Reset	=	Reset
	=	Menu	=	Menu
	=	Yes	=	Yes
	=	Yes	=	Yes
	=	No	=	No

LED's

	=	Power		=	Ready
	=	Armed/Info		=	Ready
	=	Omit		=	Service

Zone Expanders**8XP**

- 8 fully programmable DP or EOL zones
- 8 fully programmable outputs (100mA -ve applied each)
- Speaker output
- Programmable auxiliary input
- Remotely wired

60iXD

- 2 loops x 30 fully programmable iD zones
- iD biscuit technology
- Plug-on

"iD" is a registered trade mark of Chloride Safety System Limited.

Output Expanders**OP16**

- 16 fully programmable outputs (100mA each)
- 1 fault output (100mA -ve applied)
- Can be connected to mimic panels to give zone indication
- Can be connected to relays and sounders

RM8 Relay Module

- Plug-on relay card (RedCARE footprint)
- 8 separate inputs for standalone operation
- 8 x 3Amp relay outputs (n/o, n/c, com)
- Output 'ON' LED indication

Communicators**Com300**

- Multi-protocol communicator supporting Fast Format, Contact ID, SIA Level II and EasyCom Pager protocols
- 300-baud modem for remote uploading and downloading using the *Wintex UDL* software and a PC

- For use with an analogue telephone line (REN = 1)

Com2400

- Multi-protocol communicator supporting Fast Format, Contact ID, SIA Level II and EasyCom Pager and SMS Messaging protocols
- 2400-baud modem for remote uploading and downloading using the *Wintex UDL* software and a PC
- Sends SMS text messages to mobile phones
- For use with an analogue telephone line (REN = 1)

ComIP

- Multi-protocol communicator supporting Fast Format, Contact ID and SIA Level II protocols via TCP/IP
- High speed modem for remote uploading and downloading using the *Wintex UDL* software and a PC
- For use with ADSL/DSL/Broadband/WAN/LAN etc.

ComGSM

- Provides a GSM telephone path for Com300 & Com2400 Digital Communicators
- Sends SMS text messages to mobile phones
- Arm, Disarm, Reset the alarm, turn outputs on and off, omit zones and send messages to the control panel using SMS text messages
- 9600-baud modem for remote uploading and downloading using the *Wintex UDL* software and a PC

Other Devices**PC-Com**

- For connecting a PC to the control panel via an RS232 Serial port allowing local uploading and downloading using *Wintex UDL* software

USB-Com

- For connecting a PC to the control panel via a USB 1.0 or 2.0 port allowing local uploading and downloading using *Wintex UDL* software

PRINT-Com

- For connecting a serial printer to the control panel

Memory Module (not 640)

NOTE Fits onto the expansion port to provide a 10,000 event log.

Battery Splitter

NOTE Allows two backup batteries to be connected to a single set of battery terminals, and will provide appropriate monitoring and charging for each.

External Sounders

NOTE Texecom supply a range of external sounders

3. Installation

Installation Sequence

Before attempting to install the alarm system, read this section. Once you have an overall understanding of the installation sequence, carefully work through each step.

1: Design the Layout

Make a rough sketch of the premises to get an idea of where the alarm detection devices, keypads, zone expanders etc. are to be located.

2: Mounting the Panel

The control panel should be mounted in a dry area close to an unswitched AC power source and the incoming telephone line (if using a communicator).



NOTE You must complete all wiring before connecting the battery or applying AC mains to the control panel.

3: Install the Keypads and Zone Expanders

Mount and connect the keypads, zone expanders and output modules to the control panel (see page 20 for wiring details).

4: Install the Alarm Detection Devices

Install the detection devices, PIR's, Contacts, PA Buttons etc. and connect them to the control panel (see page 31 for wiring details).

5: Install the External Sounder

Install the external sounder and connect to the control panel (see page 33 for wiring details).

6: Other Wiring

Complete all other wiring including speakers, telephone line and output connections etc. (see pages 33 - 34 for details).

7: Applying Power to the Control Panel

Once steps 1 to 6 are completed, power can be applied to the control panel.

When applying power for the first time, the factory default settings must be loaded (see page 42 for details). Power should always be connected in the following order:

- Connect the red battery lead to the positive terminal of the battery and then connect the black battery lead to the negative terminal



NOTE The panel will only become 'live' when the AC Mains is connected or the 'Battery Kick-start' button is pressed.

- Connect the AC mains

For a complete list of factory default settings, see the **Quick Reference Guide** supplied with your panel.

8: Programming the Control Panel

Please refer to section 5 for instruction on programming the control panel.

9: Testing the System

Test the system thoroughly to ensure that all features and functions operate as required (see page 112 for details).

Control Panel

Mounting

Mount the control panel on a flat, plumb wall using at least three screws of appropriate size.



NOTE It is essential to ensure that none of the fixing slots or cable entries are accessible after fixing.

Mains cabling must be secured (e.g. with a cable tie) to one of the anchor points provided.

Wiring the Control Panel

WARNING: ELECTRICITY CAN KILL

BEFORE connecting the control panel ALWAYS disconnect the supply at the consumer unit. If in ANY doubt consult a qualified electrician.



IMPORTANT SAFETY INFORMATION. HAZARDOUS VOLTAGES INSIDE, NO USER SERVICEABLE PARTS, NO USER ACCESS.



NOTE ONLY connect the mains supply to the mains terminal block, NEVER connect the mains supply directly to the PCB.

ALWAYS refer to National Wiring Regulations when conducting installation.

An appropriate and readily accessible disconnection device (e.g. an unswitched fused spur) MUST be provided as part of the installation.

The disconnection device must NOT be fitted in a flexible cord.

Where identification of the neutral in the mains supply is NOT possible a two-pole disconnection device MUST be used.

Use mains cable of adequate carrying capacity for the rated current (i.e. at least 0.75mm²).

Premier Elite 24 Control Panel Layout Polymer

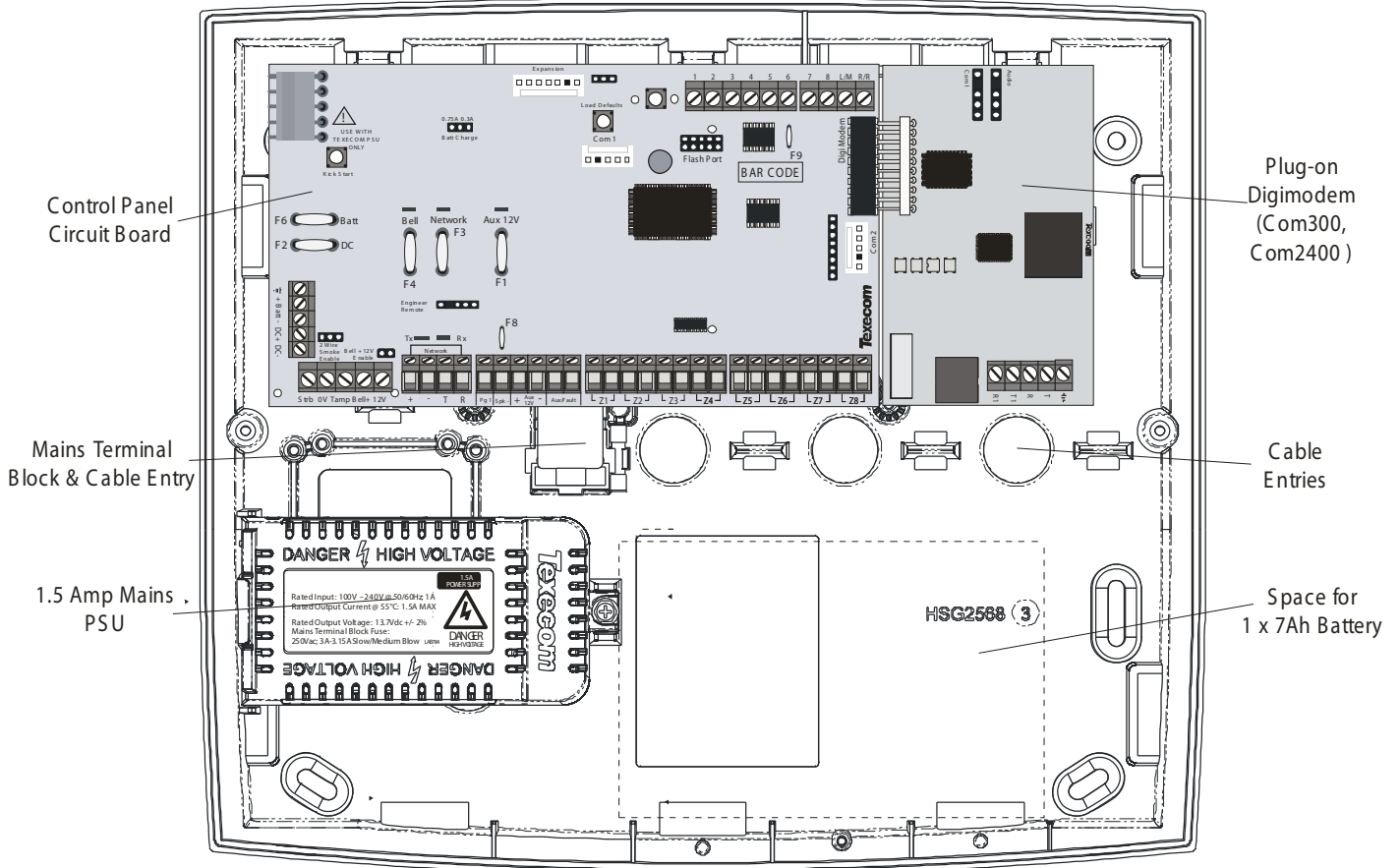

Premier Elite 24-W & 48-W Control Panel Layout

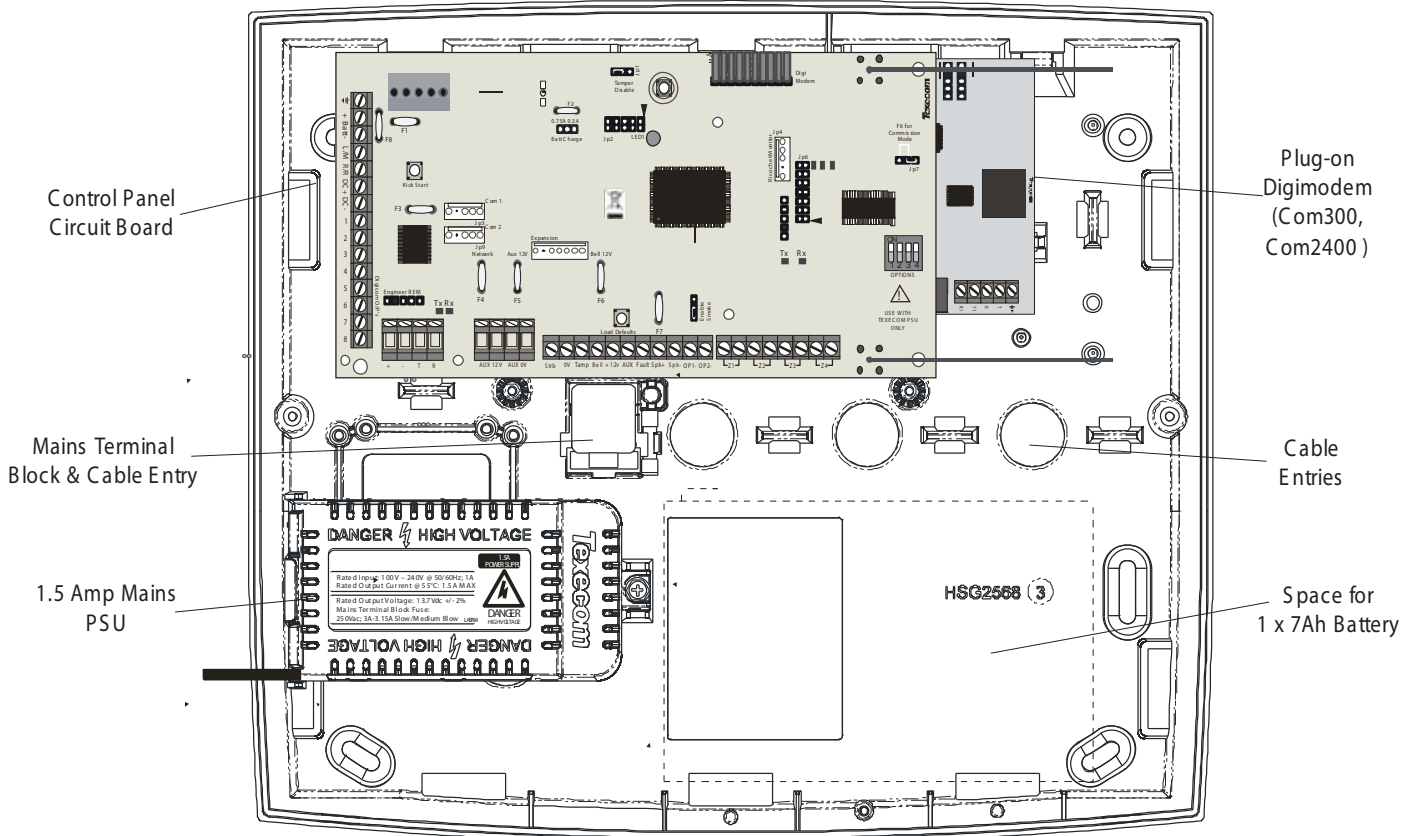

Control Panel Layout Metal All Models (168 shown)

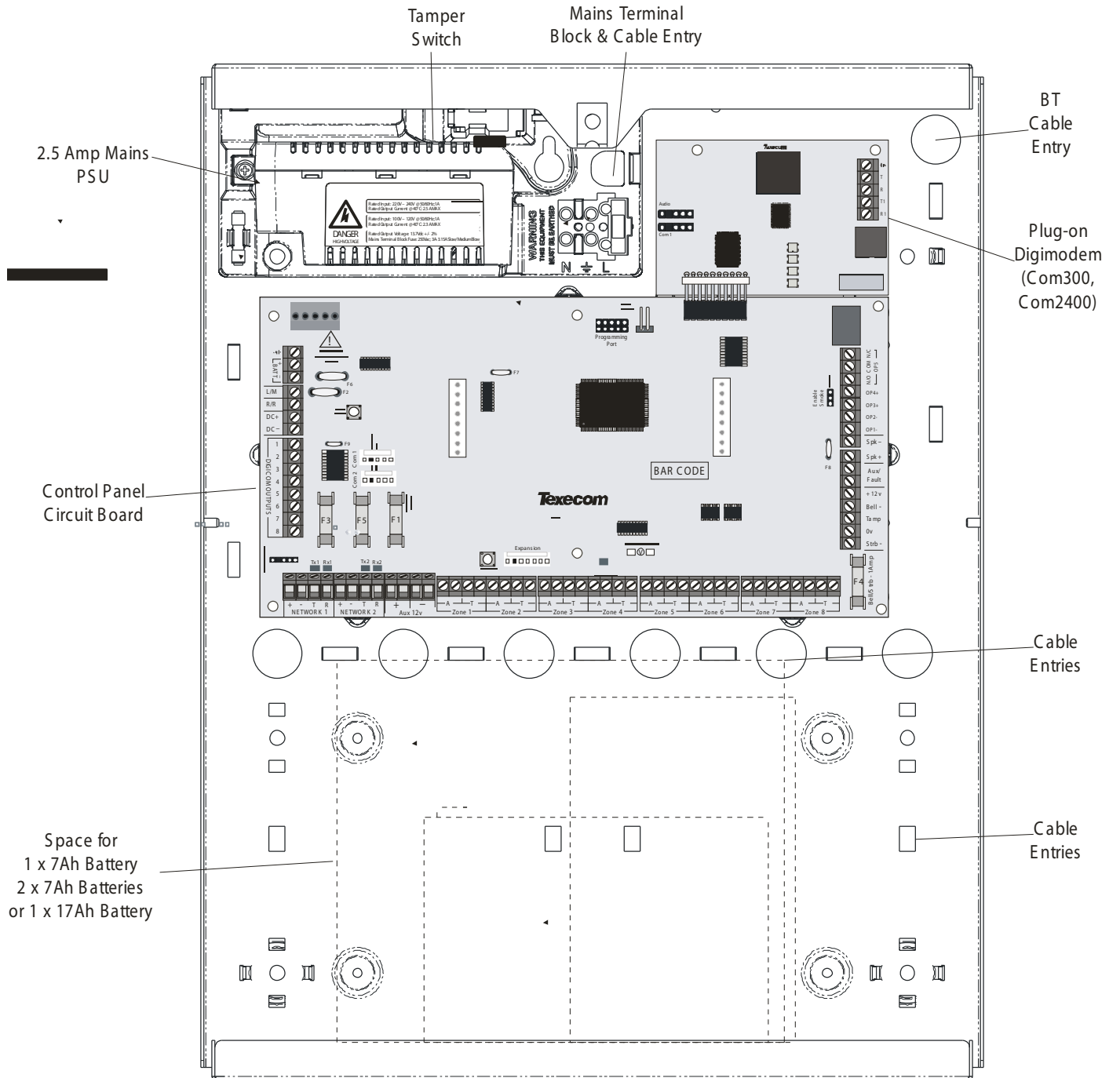

Premier Elite 24 PCB Layout

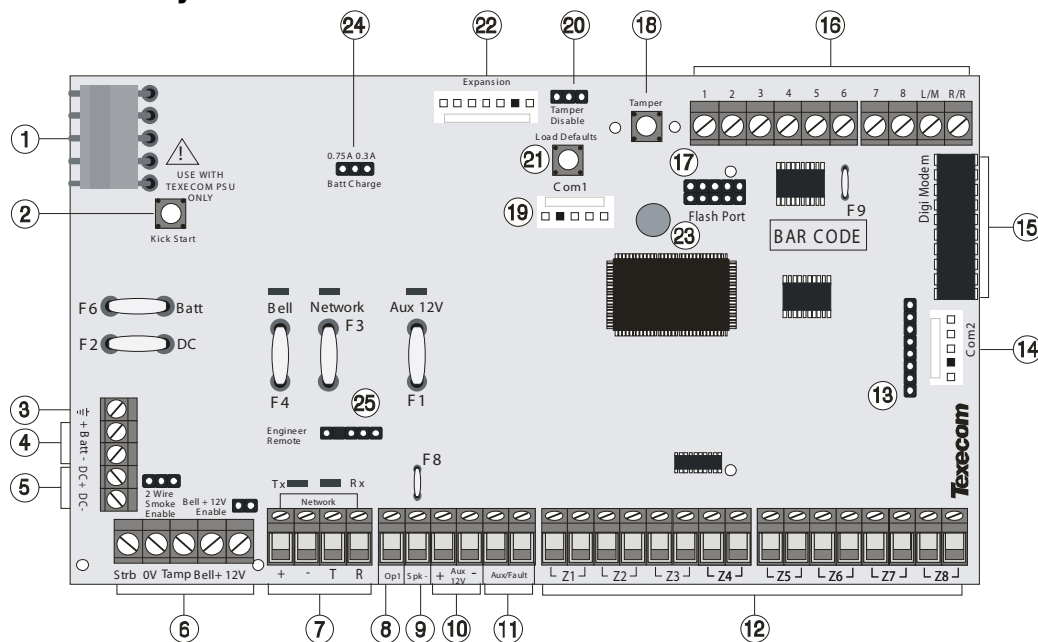

1: Texecom PSU Connection

Connect to the Texecom Switch Mode Power Supply. DO NOT CONNECT THE MAINS SUPPLY TO ANY TERMINALS ON THE PCB.

2: Battery Kick-start Button

When powering up the panel without AC Mains present, this button must be pressed in order to connect the battery.



NOTE If AC Mains is present this button does not need to be pressed.

3: Earth Connection

Connects the PCB to earth

4: Battery Connections

A 12V rechargeable battery must be connected to these terminals in order to provide continuous system operation in the event of an AC Mains failure (see page 19 for details).

5: Digicom Power

These terminals provide power; and are normally used for connecting a stand-alone communicator to the control panel (see page 34 for details).

6: External Sounder Connections

These terminals are used for connecting to an external sounder unit (see page 33 for details).

7: Network Data Connections & LED's

Networks provide connection for the keypads and zone expanders. The '+' and '-' terminals provide power whilst the 'T' transmits data and 'R' receives data (see page 20 for details). The red LED indicates that data is flowing out of the control panel and normally flashes very quickly. The green LED indicates that data is flowing into the control panel and normally flashes slowly, the green LED flashes faster as more devices are connected (see page 20 for details).

8: Panel Output 1

OP1 is a low current (500mA '-ve' applied) output (see page 34 for wiring details). The output is also fully programmable (see page 77 for programming details).

9: SPK- Loudspeaker Connection

These terminals can be used for connecting up to one 16Ω or two 8Ω loudspeakers (see page 33 for wiring details).

10: Auxiliary 12V Power

These terminals are for connecting devices that require 12V power (protected by a 1A fuse).

11: Auxiliary/ Fault Connections

These terminals can be used for monitoring the tamper loop of an auxiliary device (see page 33 for details).

12: Programmable Zones 1 - 8

These terminals provide the connections for the zones (see page 31 for wiring details). Each zone is fully programmable (see page 48 for details).

13: Expander Port

The expansion port is used for plugging on a local zone expander (see page 23 for details).

14: Com Port 2

Com Port 2 is a serial communications port and can be used for connecting a PC running *Wintex* or any supported serial device to the control panel (see page 94 for details).

15: Plug-on Communicator Connections

This socket provides connection for the plug-on communicator (see page 36 for details).

16: Digicom Outputs

Outputs 1 to 8 are low current (100mA '-ve' applied) and would normally be used when connecting a stand-alone communicator to the control panel (see page 34 for details). Each output is fully programmable (see page 77 for details). A remote reset input and a line fault input are also provided.

17: Flash Upgrade Port

For use with the *Flasher* interface to update panel firmware.

18: Box Tamper Connection

The micro switch provides tamper protection for the main control panel in case of unauthorised access.





19: Com Port 1

Com Port 1 is a serial communications port and can be used for connecting a PC running *Wintex* or any supported serial device to the control panel (see page 94 for details).

20: Tamper Disable Link

This can be used to disable the box tamper when working with the box lid removed.

21: Load Defaults Button

Press and hold this button whilst applying power to the control panel to load the factory default settings. Press and hold this button for 7 seconds with power already on the panel to restore just the Engineer code to the factory setting of    .



NOTE Loading the factory defaults can take up to 30 seconds to complete.

Loading defaults will only be possible if the NVM has not been locked (see page 64 for details).

For a complete list of factory defaults, see the **Quick Reference Guide** section of this manual.

22: Expansion

The Expansion Port can be used for connecting a 60XiD Zone Expander (see page 32 for details) or an AV Module (see page 40 for details), X-10 Module or a Memory Module.

23: Heartbeat LED/Power Light

Flashes steadily to indicate that the control panel is functioning correctly. If the light is ON or OFF all the time, then there could be a problem (see page 42 for details).

24: Battery Charge Current Selector

When using a 7Ah standby battery the charge current selector should be set to 300mA. If a 17Ah battery is connected (metal cabinet only) the selector should be set to the 750mA position.

25: Engineers Keypad

A portable Engineers keypad can be plugged on here to allow easier access for programming and testing.



NOTE When using a keypad as an Engineers keypad, the address must be set to '10' (see page 22 for details). The keypad zones and lid tamper are not monitored.

F1 – F6: Protection Fuses (electronic PTC)

The following fuses are provided:

- F1 (900mA) Auxiliary 12V Power fuse (electronic PTC)
- F2 (900mA) Digicom Power (electronic PTC)
- F3 (900mA) Network 1 fuse (electronic PTC)
- F4 (900mA) Bell/Strobe fuse (electronic PTC)
- F6 (1.6 Amp) Battery fuse (electronic PTC)

Premier Elite 24-W & 48-W PCB Layout

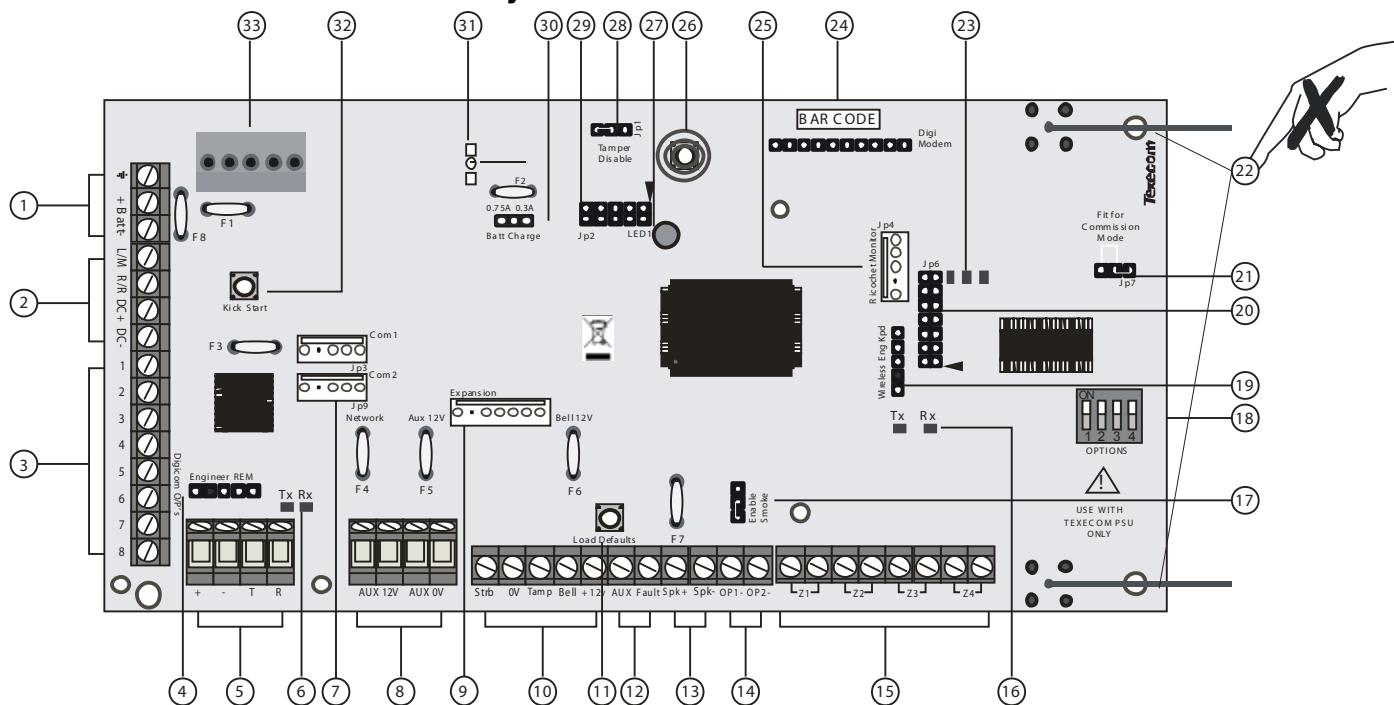

1: Battery Connections

A 12V rechargeable battery must be connected to these terminals in order to provide continuous system operation in the event of an AC Mains failure. (protected by 1.6 Amp PTC Fuse)

2: Digicom Power & Inputs

These terminals provide un-fused power; remote reset and line fault inputs and are normally used for connecting a stand-alone communicator to the control panel.

3: Digicom Outputs

Outputs 1 to 8 are low current (100mA '-ve' applied) and would normally be used when connecting a stand-alone communicator to the control panel. Each output is fully programmable.

4: Engineers Keypad

A portable Engineers keypad can be plugged on here to allow easier access for programming and testing.

NOTE When using a keypad as an Engineers keypad, the address must be set to '10'. The keypad zones and lid tamper are not monitored.

5: Network Data Connections

Network 1 provides connection for the keypads and zone expanders. The '+' and '-' terminals provide power whilst the 'T' transmits data and 'R' receives data.

6: Network Data Indicators

The red LED indicates that data is flowing out of the control panel and normally flashes very quickly. The green LED indicates that data is flowing into the control panel and normally flashes slowly, the green LED flashes faster as more devices are connected.

7: Communication Ports

Com Port 1 is a serial communications port and can be used for connecting a PC running *Wintex* or any supported serial device to the control panel.

Com Port 2 is a serial communications port and can be used for connecting a PC running *Wintex* or any supported serial device to the control panel.

8: Auxiliary 12V Power

These terminals are for connecting devices that require 12V power (protected by a 0.9A PTC fuse).

9: Expansion

The Expansion Port can be used for connecting a 60XiD Zone Expander (see page 32 for details) or an AV Module (see page 40 for details), X-10 Module or a Memory Module.

10: External Sounder Connections

These terminals are used for connecting to an external sounder unit.

11: Load Defaults Button

Press and hold this button whilst applying power to the control panel to load the factory default settings. Press and hold this button for 7 seconds with power already on the panel to restore just the Engineer code to the factory setting of (1) (2_{abc}) (3_{def}) (4_{ghi}).

NOTE Loading the factory defaults can take up to 30 seconds to complete.

Loading defaults will only be possible if the NVM has not been locked.

For a complete list of factory defaults, see the **Quick Reference Guide** supplied on the enclosed CD.

12: Auxiliary/Fault Connections

These terminals can be used for monitoring the tamper loop of an auxiliary device (see page 33 for details).

13: Loudspeaker Connections

These terminals can be used for connecting up to one 8Ω or two 16Ω loudspeakers.

14: Panel Outputs

Outputs 1 & 2 are 500mA '-ve'. These outputs are all fully programmable. (24-W only output 1)

15: Zone Connections

4 Fully programmable zone inputs

16: Ricochet™ Network LED's

Green LED = Data received by the expander from the panel Red LED = Data transmitted by the expander to the panel. (The flash rate depends on the mode and RF activity)

17: Enable 2 wire smoke

Panel Output 1 can be used for connecting up to 10, 12V 2-Wire smoke detectors.

18: Options Switch

Use to select the receiver functionality.

Switch 1 OFF = not used on 48-W.

Switch 2 OFF = 24-W & 48-W **RICOCHET™** Mode

ON = Not Used

Switch 3 ON = Impaq Contact-W Wired Input 2 will report as Tamper (default)

OFF = input 2 will report as an Alarm.

Switch 4 OFF Walk test

19: RICOCHET™ Eng keypad connection

An engineer's keypad (LCD keypad and interface lead) can be temporarily plugged onto this connector to allow system programming and testing. Set the keypad address switches to all ON.

20: RICOCHET™ Firmware Flash Port

Connections for flasher interface to update **RICOCHET™** receiver firmware.

21: Commission Mode Jumper

Fit when learning and placing devices, remove once complete.

22: Antenna

RF antenna

23: RF LED's

Left = RED Transmit, Middle = GREEN Receive, Right = RED Wireless Network Tick.

24: Plug-on Communicator Connections

This socket provides connection for COM300/COM2400 plug-on communicators via the lead provided.

25: Ricochet™ Comm. Port Connection

Serial communications port for connecting to a PC via PC Com/USB Com or Com IP for use with **RICOCHET™ Monitor** Software.

26: Cover Tamper

Provides tamper protection for the control panel.

27: Heartbeat LED/Power Light

Flashes steadily to indicate that the control panel is functioning correctly. If the light is ON or OFF all the time, then there could be a problem.

28: Cover Tamper Disable

Disables the lid tamper

29: Flash Programming Port

For upgrading the panel firmware.

30: Battery Charge Selection

Select .03A or 0.75A battery charging current

31: Current Reading Pads

To calculate the current draw of the control panel, measure the voltage across the two pads and multiply by 10 i.e. Reading = 34mV (x10) = 340mV = 340mA.

32: Battery Kick-start Button

When powering up the panel without AC Mains present, this button must be pressed in order to connect the battery. If AC Mains is present this button does not need to be pressed.

33: Power Supply Connection

Only for use with the Texecom PSU.

DO NOT CONNECT ANY OTHER MAINS SUPPLY TO THESE TERMINALS

PTC Protection Fuses

The following fuses are provided:

F6 PTC (0.9A) Auxiliary 12V Power fuse

F4 PTC (0.9 A) Network 1 fuse

F5 PTC (0.9 A) Bell/Strobe fuse

Premier Elite 48/88/168 PCB Layout

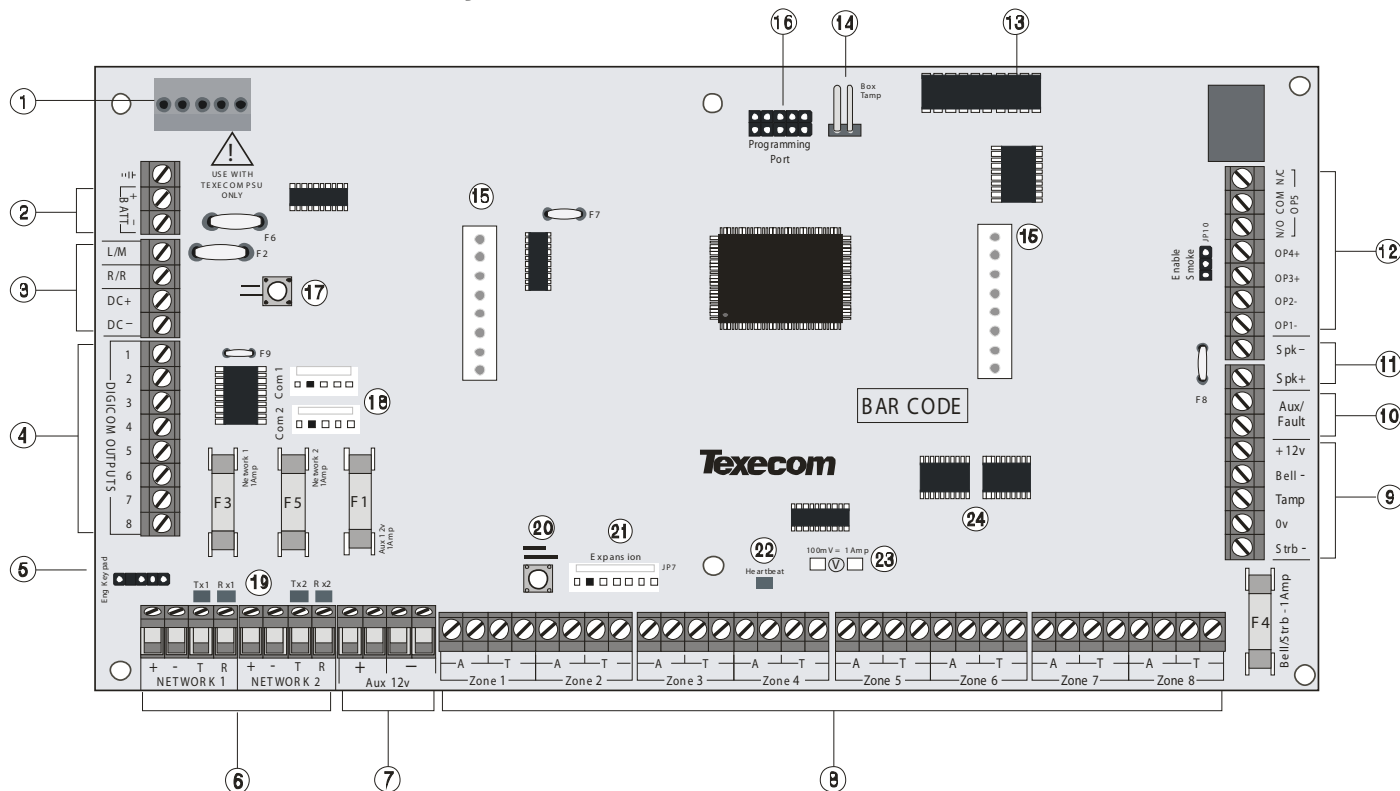

1: Texecom PSU Connection

Connected to the Texecom Switch Mode Power Supply. DO NOT CONNECT THE MAINS SUPPLY TO THE AC INPUT TERMINALS ON THE PCB.

2: Battery Connections

A 12V rechargeable battery must be connected to these terminals in order to provide continuous system operation in the event of an AC Mains failure (see page 19 for details).

3: Digicom Power & Inputs

These terminals provide unfused power; remote reset and line fault inputs and are normally used for connecting a stand-alone communicator to the control panel (see page 34 for details).

4: Digicom Outputs

Outputs 1 to 8 are low current (100mA ‘-ve’ applied) and would normally be used when connecting a stand-alone communicator to the control panel (see page 34 for details). Each output is fully programmable (see page 77 for details).

5: Engineers Keypad

A portable Engineers keypad can be plugged on here to allow easier access for programming and testing.

NOTE When using a keypad as an Engineers keypad, the address must be set to ‘10’ (see page 22 for details). The keypad zones and lid tamper are not monitored.

6: Network Data Connections

Networks provide connection for the keypads and zone expanders. The ‘+’ and ‘-’ terminals provide power whilst the ‘T’ transmits data and ‘R’ receives data (see page 20 for details).

7: Auxiliary 12V Power

These terminals are for connecting devices that require 12V power (protected by a 1A fuse).

8: Programmable Zones 1 - 8

These terminals provide the connections for the zones (see page 31 for wiring details). Each zone is fully programmable (see page 48 for details).

9: External Sounder Connections

These terminals are used for connecting to an external sounder unit (see page 33 for details).

10: Auxiliary/Fault Connections

These terminals can be used for monitoring the tamper loop of an auxiliary device (see page 33 for details).

11: Loudspeaker Connections

These terminals can be used for connecting up to one 16Ω or two 8Ω loudspeakers (see page 33 for details).

12: Panel Outputs

Outputs 1 & 2 are 500mA ‘-ve’ applied, outputs 3 & 4 are 500mA ‘+ve’ applied and output 5 is a clean contact relay (see page 34 for wiring details). These outputs are all fully programmable (see page 76 for details).

NOTE Panel outputs 3, 4 and 5 are only available on the 88 and 168.

13: Plug-on Communicator Connections

This socket provides connection for the plug-on communicator (see page 36 for details).

14: Box Tamper Connection

The box tamper micro switch is connected here. The micro switch provides tamper protection for the main control panel in case of unauthorised access. To disable the box tamper, remove the micro switch lead and fit a jumper link across the two pins.

15: Plug-on RedCARE/Dualcom Connections

These pins provide connections for a plug-on RedCARE, Dualcom, Digicom or RM8 Relay module. Each output is fully programmable (see page 77 for details).

NOTE When a device is plugged on to these pins, not all outputs may be available, please refer to the relevant documentation for details.

16: Flash Upgrade Port

For use with the Flasher interface to update panel firmware.

17: Battery Kick-start Button

When powering up the panel without AC Mains present, this button must be pressed in order to connect the battery.

NOTE If AC Mains is present this button does not need to be pressed.

18: Communication Ports

Com Port 1 is a serial communications port and can be used for connecting a PC running *Wintex* or any supported serial device to the control panel (see page 94 for details).

Com Port 2 is a serial communications port and can be used for connecting a PC running *Wintex* or any supported serial device to the control panel (see page 94 for details).

19: Network Data Indicators

The red LED indicates that data is flowing out of the control panel and normally flashes very quickly. The green LED indicates that data is flowing into the control panel and normally flashes slowly, the green LED flashes faster as more devices are connected (see page 20 for details).



NOTE

For a complete list of factory defaults, see the **Quick Reference Guide** supplied with your panel.

20: Load Defaults Button

Press and hold this button whilst applying power to the control panel to load the factory default settings. Press and hold this button for 7 seconds with power already on the panel to restore just the Engineer code to the factory setting of **1** **2_{abc}** **3_{def}** **4_{ghi}**.



NOTE

Loading the factory defaults can take up to 30 seconds to complete.

Loading defaults will only be possible if the NVM has not been locked (see page 64 for details).

21: Expansion

The Expansion Port can be used for connecting a 60XiD Zone Expander (see page 32 for details) or an AV Module (see page 40 for details), X-10 Module or a Memory Module.

22: Heartbeat LED/Power Light

Flashes steadily to indicate that the control panel is functioning correctly. If the light is ON or OFF all the time, then there could be a problem (see page 42 for details).

23: Current Reading Pads

To calculate the current draw of the control panel, measure the voltage across the two pads and multiply by 10 i.e. Reading = 34mV (x10) = 340mV = 340mA.

24: NVM 1 & 2

All system programming data and the event log is stored in one or two non-volatile memory devices.

F1 - F5: Protection Fuses (48, 88 and 168)

The following fuses are provided:

- F1 (1Amp) Auxiliary 12V Power fuse
- F2 (1.6 Amp) Battery fuse (electronic PTC)
- F3 (1 Amp) Network 1 fuse
- F4 (1 Amp) Bell/Strobe fuse
- F5 (1 Amp) Network 2 fuse (168 only)

Premier Elite 640 PCB Layout

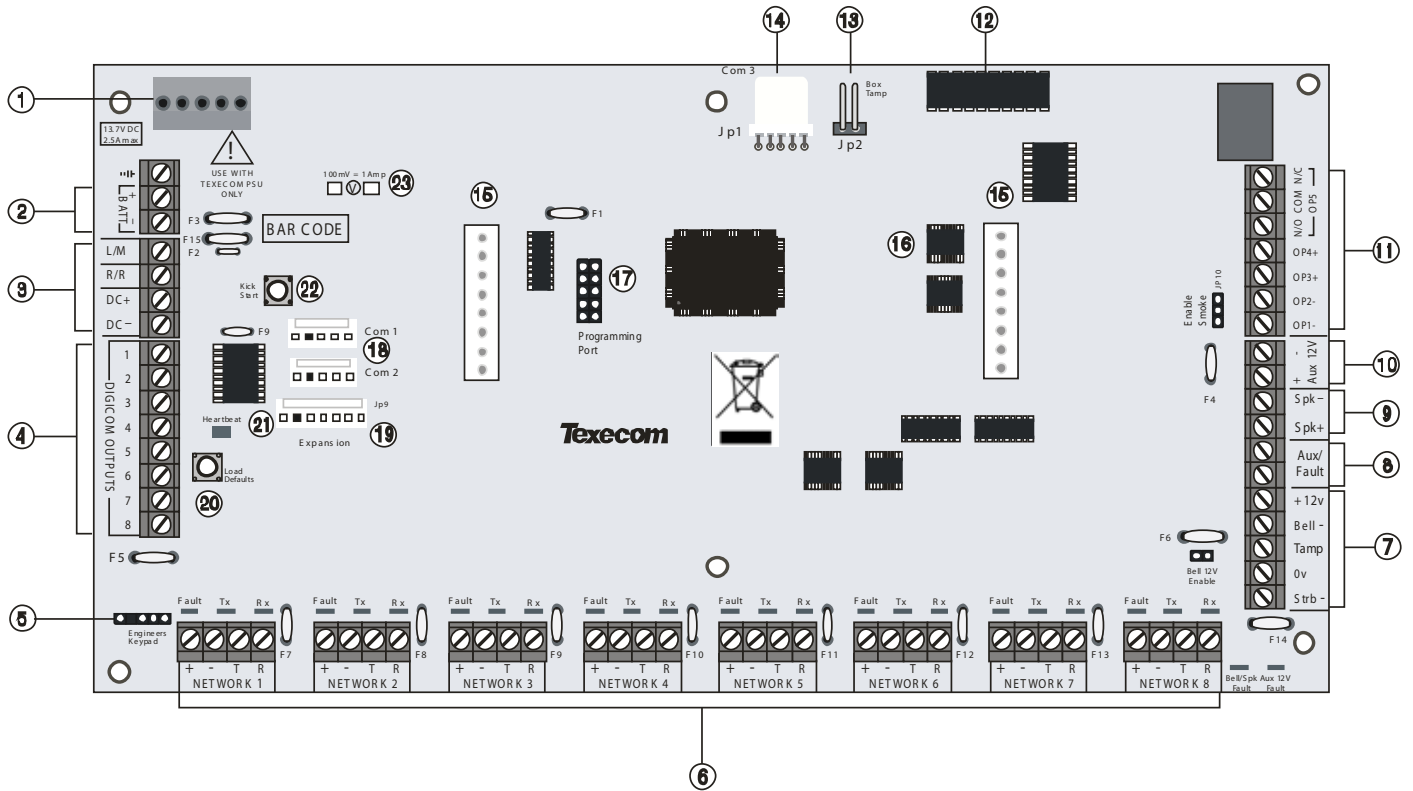

1: Texecom PSU Connection

Connected to the Texecom Switch Mode Power Supply. DO NOT CONNECT THE MAINS SUPPLY TO THE AC INPUT TERMINALS ON THE PCB.

2: Battery Connections

A 12V rechargeable battery must be connected to these terminals in order to provide continuous system operation in the event of an AC Mains failure (see page 19 for details).

3: Digicom Power & Inputs

These terminals provide unfused power; remote reset and line fault inputs and are normally used for connecting a stand-alone communicator to the control panel (see page 34 for details).

4: Digicom Outputs

Outputs 1 to 8 are low current (100mA '-ve' applied) and would normally be used when connecting a stand-alone communicator to the control panel (see page 34 for details). Each output is fully programmable (see page 77 for details).

5: Engineers Keypad

A portable Engineers keypad can be plugged on here to allow easier access for programming and testing.

NOTE When using a keypad as an Engineers keypad, the address must be set to '10' (see page 22 for details). The keypad zones and lid tamper are not monitored.

6: Network Data Connections

Networks 1 - 8 provide connection for the keypads and zone expanders. The '+' and '-' terminals provide power whilst the 'T' transmits data and 'R' receives data (see page 20 for details).

7: External Sounder Connections

These terminals are used for connecting to an external sounder unit (see page 33 for details).

8: Auxiliary/Fault Connections

These terminals can be used for monitoring the tamper loop of an auxiliary device (see page 33 for details).

9: Loudspeaker Connections

These terminals can be used for connecting up to one 16 or two 8 loudspeakers (see page 33 for details).

10: Auxiliary 12V Power

These terminals are for connecting devices that require 12V power (protected by a 1A fuse).

11: Panel Outputs

Outputs 1 & 2 are 500mA '-ve' applied, outputs 3 & 4 are 500mA '+ve' applied and output 5 is a clean contact relay (see page 34 for wiring details). These outputs are all fully programmable (see page 76 for details).

12: Plug-on Communicator Connections

This socket provides connection for the plug-on communicator (see page 36 for details).

13: Box Tamper Connection

The box tamper micro switch is connected here. The micro switch provides tamper protection for the main control panel in case of unauthorised access. To disable the box tamper, remove the micro switch lead and fit a jumper link across the two pins.

14: Com Port 3

Com Port 3 is a serial communications port and can be used for connecting a PC running *Wintex* or any supported serial device to the control panel (see page 94 for details).

15: Plug-on RedCARE/Dualcom Connections

These pins provide connections for a plug-on RedCARE, Dualcom, Digicom or *RM8 Relay module*. Each output is fully programmable (see page 77 for details).

NOTE When a device is plugged on to these pins, not all outputs may be available, please refer to the relevant documentation for details.

16: NVM 1 & 2

All system programming data and the event log is stored in one or two non-volatile memory devices.

17: Flash Upgrade Port

For use with the *Flasher* interface to update panel firmware.

18: Communication Ports 1&2

Com Port 1 is a serial communications port and can be used for connecting a PC running *Wintex* or any supported serial device to the control panel (see page 94 for details).

Com Port 2 is a serial communications port and can be used for connecting a PC running *Wintex* or any supported serial device to the control panel (see page 94 for details).

19: Expansion

The Expansion Port can be used for connecting a 60XiD Zone Expander (see page 32 for details) or an AV Module (see page 40 for details), X-10 Module or a Memory Module.

20: Load Defaults Button

Press and hold this button whilst applying power to the control panel to load the factory default settings. Press and hold this button for 7 seconds with power already on the panel to restore just the Engineer code to the factory setting of **1** **2_{abc}** **3_{def}** **4_{ghi}**.



NOTE Loading the factory defaults can take up to 60 seconds to complete.

Loading defaults will only be possible if the NVM has not been locked (see page 64 for details).

21: Heartbeat LED/Power Light

Flashes steadily to indicate that the control panel is functioning correctly. If the light is ON or OFF all the time, then there could be a problem (see page 42 for details).

22: Battery Kick-start Button

When powering up the panel without AC Mains present, this button must be pressed in order to connect the battery.



NOTE If AC Mains is present this button does not need to be pressed.

23: Current Reading Pads

To calculate the current draw of the control panel, measure the voltage across the two pads and multiply by 10 i.e. Reading = 34mV (x10) = 340mV = 340mA.

F1 – F14: Protection Fuses

The following electronic fuses are provided:

- F3 (1600 mA) Battery
- F4 (250mA) Speaker
- F5 (900mA) Network 1
- F6 (900mA) Bell/Strobe
- F7 (900mA) Network 2
- F8 (900mA) Network 3
- F9 (900mA) Network 4
- F10 (900mA) Network 5
- F11 (900mA) Network 6
- F12 (900mA) Network 7
- F13 (900mA) Network 8
- F14 (900mA) Auxiliary 12V

Power Supply Ratings

If installing to EN50131 or PD6662, the system standby times in the event of a mains power failure vary depending on the grade and how AC fail is signalled:



NOTE When calculating the current consumption of the system you must include the current taken by the control panel and all the devices that it powers. If the total current exceeds the "Rated Output" for the grade you are installing to then an additional power supply is required

Premier Elite 24 (Metal)

Current

Current Consumption	95mA
Maximum Current Available	
0.75A charge	1.0A
0.3A charge	1.9A

Rated Output

Battery Arrangement	Battery Charge	Rated Output (Amps)			
		12h	24h	30h	60h
1 x 7Ah	0.3A	0.48A	0.19A	0.13A	0.021A
1 x 17Ah	0.3A	1.32A	0.61A	0.47A	0.18A
	0.75A	1.0A	0.61A	0.47A	0.18A

Standby and Recharge Times

EN50131-1	Grade 1	Grade 2	Grade 3
Minimum Standby Period	12h	12h	30h *
Maximum Recharge Time	72 Hrs	72 Hrs	24 Hrs
PD6662	Grade 1	Grade 2	Grade 3
Standby Period	12 Hrs	12 Hrs	24 Hrs **
Maximum Recharge Time	72 Hrs	72 Hrs	24 Hrs

*30h if MAINS FAIL is reported to ARC, otherwise 60h

**This time may be halved if mains failure is signalled to an ARC

Jumper Settings

Battery Arrangement	Recharge Time	Battery Charge Selector
1 x 7Ah	< 24Hrs	0.3 A
1 x 17Ah	< 24Hrs	0.75 A
	< 72Hrs	0.3 A

Premier Elite 24 (Polymer)

Current

Current Consumption	95mA
Maximum Current Available	
0.3A charge	1.1A

Rated Output

Battery Arrangement	Battery Charge	Rated Output (Amps)
		12h
1 x 7Ah	0.3A	0.48A

Standby and Recharge Times

EN50131-1	Grade 1	Grade 2
Minimum Standby Period	12h	12h
Maximum Recharge Time	72 Hrs	72 Hrs
PD6662	Grade 1	Grade 2
Standby Period	12 Hrs	12 Hrs
Maximum Recharge Time	72 Hrs	72 Hrs

Premier Elite 48/88/168

Current

Current Consumption	125mA
Maximum Current Available	
0.75A charge	1.0A
0.3A charge	1.9A

Rated Output

Battery Arrangement	Battery Charge	Rated Output (Amps)			
		12h	24h	30h	60h
1 x 7Ah	0.3A	0.458A	0.166A	0.108A	
1 x 17Ah	0.3A	1.29A	0.583A	0.441A	0.158A
	0.75A	1.0A	0.583A	0.441A	0.1588A

Standby and Recharge Times

EN50131-1	Grade 1	Grade 2	Grade 3
Minimum Standby Period	12h	12h	30h *
Maximum Recharge Time	72 Hrs	72 Hrs	24 Hrs
PD6662	Grade 1	Grade 2	Grade 3
Standby Period	12 Hrs	12 Hrs	24 Hrs **
Maximum Recharge Time	72 Hrs	72 Hrs	24 Hrs

*30h if MAINS FAIL is reported to ARC, otherwise 60h

**This time may be halved if mains failure is signalled to an ARC

Jumper Settings

Battery Arrangement	Recharge Time	Battery Charge Selector
1 x 7Ah	< 24Hrs	0.3 A
1 x 17Ah	< 24Hrs	0.75 A
	< 72Hrs	0.3 A

Premier Elite 640

Current

Current Consumption	125mA
Maximum Current Available	
0.75A charge	1.0A

Rated Output

Battery Arrangement	Battery Charge	Rated Output (Amps)			
		12h	24h	30h	60h
1 x 17Ah	0.75A	1.0A	0.558A	0.416A	0.133A

Standby and Recharge Times

EN50131-1	Grade 1	Grade 2	Grade 3
Minimum Standby Period	12h	12h	30h *
Maximum Recharge Time	72 Hrs	72 Hrs	24 Hrs
PD6662	Grade 1	Grade 2	Grade 3
Standby Period	12 Hrs	12 Hrs	24 Hrs **
Maximum Recharge Time	72 Hrs	72 Hrs	24 Hrs

*30h if MAINS FAIL is reported to ARC, otherwise 60h

**This time may be halved if mains failure is signalled to an ARC

Premier Elite 24-W & 48-W

Current

Current Consumption	150mA
Maximum Current Available	
0.3A charge	1.0A

Rated Output

Battery Arrangement	Battery Charge	Rated Output (Amps)
		12h
1 x 7Ah	0.3A	0.433A

Standby and Recharge Times

EN50131-1	Grade 1	Grade 2
Minimum Standby Period	12h	12h
Maximum Recharge Time	72 Hrs	72 Hrs
PD6662	Grade 1	Grade 2
Standby Period	12 Hrs	12 Hrs
Maximum Recharge Time	72 Hrs	72 Hrs

Connecting AC Mains

The AC Mains supply is connected to a 3 way 'Euro Type' fused terminal block, which is fitted with a 3.15A medium/slow blow fuse.



NOTE All other wiring **MUST** be carried out before AC mains is connected to the control panel.

After connecting the AC Mains, fit the mains cover, this can be found in the spares bag.

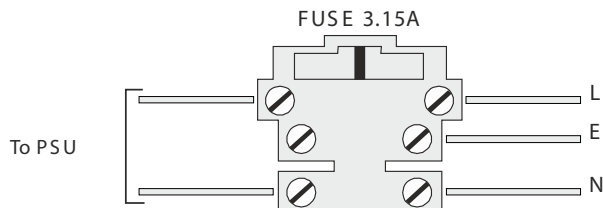

Connecting Batteries

If installing to PD6662: 2004 then only One 12V 7Ah battery or 12V 17Ah battery can be fitted inside the control panel to provide continued operation in the event of an AC mains failure, otherwise, two 12V 7Ah batteries can be connected.



NOTE All other wiring **MUST** be carried out before the battery is connected to the control panel.

Connect the red battery lead to the positive terminal of the battery and then connect the black battery lead to the negative terminal.



NOTE The panel will only become 'live' when the AC Mains is connected or the 'Battery Kick-start' button is pressed.

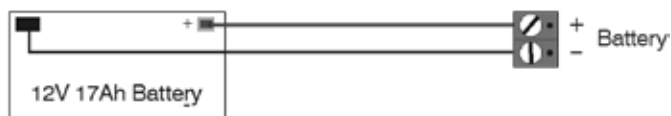

OR

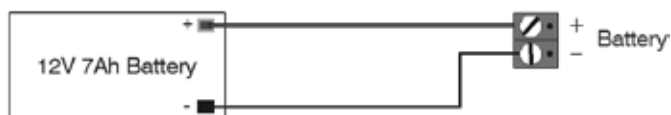

OR

If not installing to PD6662: 2004

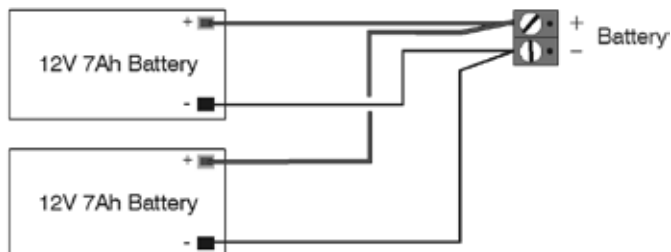

NOTE Two batteries can be fitted and still comply with PD6662:2004 if the **Battery Splitter** is used.

Connecting Devices to the Network

Before connecting keypads, zone expanders and output modules, isolate ALL power from the control panel (AC Mains & Battery). Do not continue if there is still power present on the control panel.

NOTE Connecting devices with power still present on the control panel may damage the device or control panel and invalidate any warranty.

Keypads, zone expanders and output modules are all connected to the same network terminals located at the bottom left hand corner of the control panel and may be connected serially (daisy chain), in parallel (star) or any combination of the two (see Figure 1, page 21 for details).

NOTE No more than 8 zone expanders, 8 keypads and 4 output modules can be connected to each network.

The maximum number of devices that can be connected in total will depend on the control panel fitted.

Whenever new devices are connected to the networks, they must be confirmed onto the system using the 'Confirm Devices' menu option (see page 117 for details).

Wiring the Network

The networks are made up of four terminals incorporating power and data. To ensure correct operation, all four terminals on the device must be connected to the corresponding terminals on the control panel, or previous device (see Figure 1, page 21 for details). The table below shows each terminal and its description:

Terminal	Description
+	+12V Supply
-	0V Supply
T	Transmit Data
R	Receive Data

Devices can be connected using 4-core cable. However, it is recommended that 6 or 8-core cable is used as the spare cores can be used to 'Double Up' on the power connections if needed.

NOTE Standard 7/0.2 alarm cable can be used for most installations. However, under certain conditions it may be necessary to use screened cable.

Cable Distances

The maximum recommended distance for devices when using standard 7/0.2 alarm cable is:

- 250m for each branch when using the star (parallel) configuration
- When using a daisy chain (series) configuration the maximum distance will depend on the number of devices connected on the chain. The more devices that are connected, the shorter the distance to the last device (this is due to voltage drop in the cable)

Whichever method of wiring configuration is used, ensure that the voltage between the '+' and '-' terminals at each device is no lower than 10.0V when the system is running on the standby battery.

The table below shows maximum cable runs when one keypad or expander is installed using standard 7/0.2 alarm cable with various loads:

Configuration	Max. Cable Run
1. Keypad + 2 PIR's @15mA	250m
2. Expander + 2 PIR's @15mA	250m
3. Expander + 8 PIR's @15mA	100m
4. As No. 3 + 16Ω Speaker	30m

Distances of up to 1km can be achieved between the control panel and a device. However, a power supply must be installed close to the device to power it locally, this will help to overcome voltage drop caused by the long cable run.

Overcoming Voltage Drop

There are several ways to overcome voltage drop:

- Use thicker lower resistance cable. Standard 7/0.2 alarm cable has a resistance of 8Ω per 100m
- Double up on the power connections – this will require using a 6 or 8-core cable rather than a 4-core cable
- Install a power supply to power the device locally, remember to common the two negative connections

Installing a Power Supply

When a power supply is installed, the 0V connections on the power supply must be connected through to 0V on the control panel and the +12V connection between the control panel and the device must be disconnected (see Figure 2, page 21 for details).

Network Diagnostics

Each network has two LED's to indicate data flow. The red LED indicates data flowing out of the 'T' terminal and the green LED indicates data flowing into the 'R' terminal. The table below shows each LED status and its meaning:

LED Status	'T' Wire OUT	'T' Wire IN
Red LED Flashing	Normal	Normal
Red LED On	Panel Fault	Cable Short
Red LED Off	Panel Fault	Panel Fault

LED Status	'R' Wire OUT	'R' Wire IN
Green LED Flashing	Panel Fault	Normal
Green LED On	Panel Fault	Cable Short
Green LED Off	Normal	No Data From Devices

NOTE The LED's are provided as an aid for fault finding and therefore should not be completely relied upon to indicate that there is a fault.

Figure 1: Network Connections (250m without additional power supply).

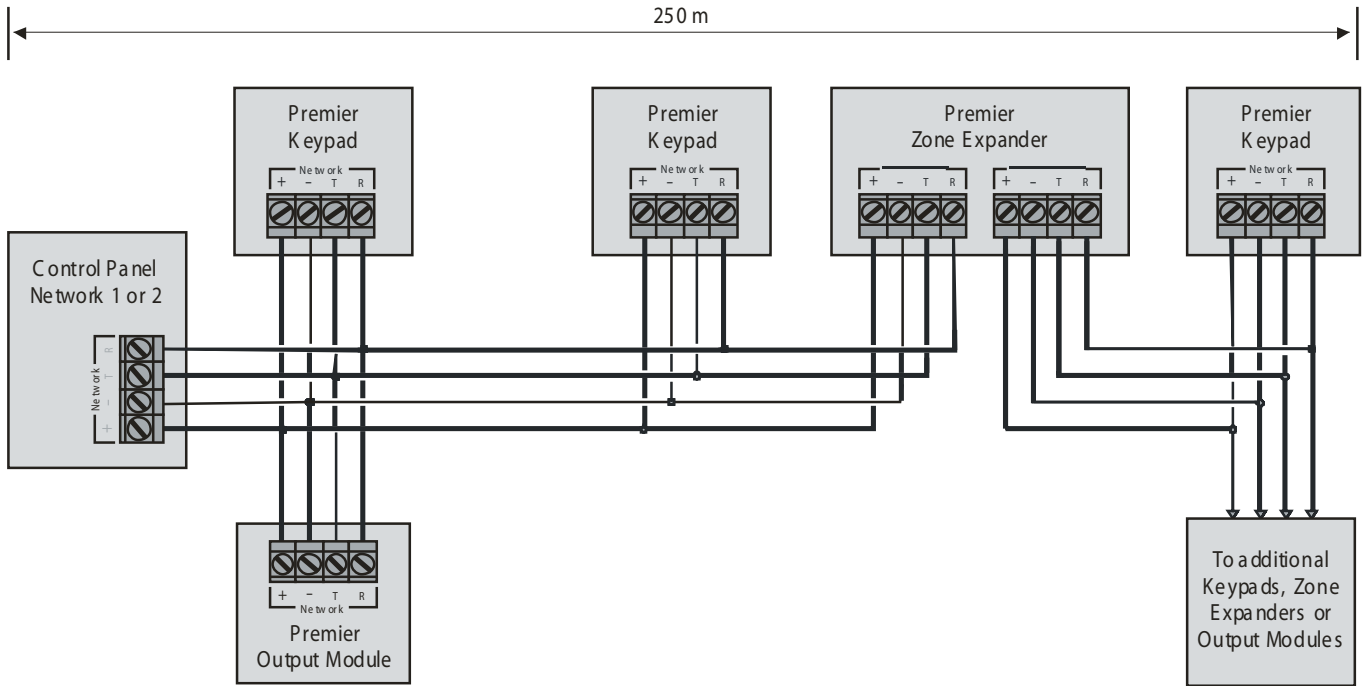
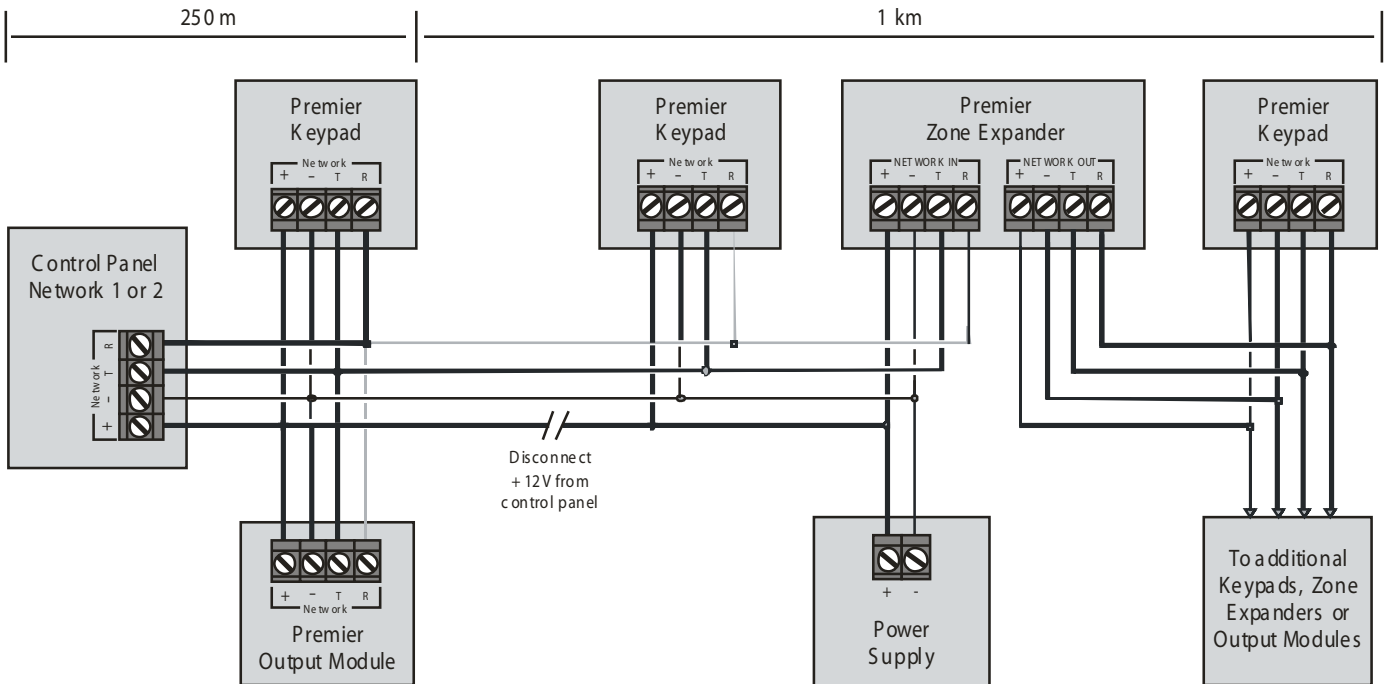
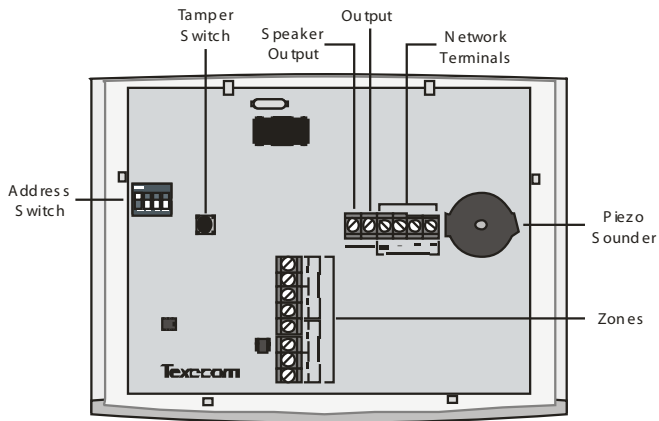

Figure 2: Network Connections (1km with additional power supply).



Remote Keypads

Keypad Layout



Connecting Keypads

Keypads are connected to the network terminals located at the bottom left hand corner of the control panel (see pages 20 & 21 for details).

Keypad Addressing

Each keypad must be assigned a different address using the DIL switches located on the left hand side of the PCB. The table below shows the keypad addressing:

Address	DIL 1	DIL 2	DIL 3	DIL 4	
1	On or Off	Off	Off	Off	
2	Off	On	Off	Off	
3	Off	Off	On	Off	
4	Off	Off	Off	On	
5 *	On	Off	Off	On	
6 *	Off	On	Off	On	
7 *	Off	Off	On	On	
8 *	On	Off	On	On	
Engineers	On	On	On	On	

NOTE Never set two keypads on the same network to the same address.

When using a keypad as an Engineer's keypad, the DIL switches must all be 'On'.

* 88 168 & 640 only

Keypad Zones

The keypad has two programmable zones (see page 31 for details). Each zone is also fully programmable (see page 48 for details).

Zone Numbering

The table below shows the zone allocation when the keypads are installed:

Address	Zones (Network 1)	Zones (Network 2)
1	Unmapped	Unmapped
2	Unmapped	Unmapped
3	Unmapped	Unmapped
4	Unmapped	Unmapped
5 *	Unmapped	Unmapped
6 *	Unmapped	Unmapped
7 *	Unmapped	Unmapped
8 *	Unmapped	Unmapped
Address	Zones (Network 3,4 & 5)	Zones (Network 6 7 & 8)
1-8 **	Unmapped	Unmapped

NOTE The zones inside the keypads are not seen by the system until they have been mapped to a zone number (see page 73 for details).

* 88 168 only

** 640 only

Keypad Output

The remote keypad has one programmable output, which can be used to drive auxiliary devices such as LED's, sounders or relays etc. Wire as per Panel Outputs shown on page 34 (see page 76 for details). The electrical characteristics for the output are shown below:

Output	Max Current	Type
1	100mA	Switched -ve

Keypad Speaker Output (LCDL/LCDLP Only)

The LCDL and LCDLP keypads have an output that can be used for driving up to one 16Ω or two 8Ω loudspeakers (see page 33 for details).

NOTE The speaker volume is also fully adjustable (see page 73 for details).

Programmable 'Info.' LED

The 'Info.' LED on the front of the keypad can be programmed to mimic the keypad output or show the armed status of an area (see page 73 for details).

Adjustable Backlighting

To adjust the keypad backlighting press the YES key for 5 seconds, then with the YES key still pressed use to increase or decrease the backlighting until the required brightness is achieved, then release both keys.

NOTE The backlight can only be adjusted when the keypad is not in a menu.

Keypad Lid Tamper

The lid tamper of each keypad can be disabled if required using the relevant keypad option in the Keypad Setup menu (see page 73 for details).

8XP-W & 32XP-W V2.xx >**Ricochet MT2**

The **Premier Elite Series™** of control panels have been upgraded to V2.xx firmware which now contains **Ricochet™ MT2** capability. This new technology adds additional features and functions for **Ricochet™** enabled security systems. The Expanders used must be **Premier Elite XP-W V2.xx**.



NOTE DO NOT mix V1 & MT2 expanders on the same Premier Elite panel

Multiple Expander Support

It is now possible to add multiple expanders to the system allowing for greater flexibility in system design, and also taking wireless capability to new levels. Additional device modes and diagnostics functions also give more information about the system status, and allow greater control over devices modes of operation.

Control Panel Capacity

The table below details the maximum number of expanders, devices and **Premier Elite SmartKey™** that may be used on the different control panels, other configurations may be possible by mixing **Premier Elite 32XP-W & Premier Elite 8XP-W**.

Panel	32XP-W			8XP-W		
	Expanders	Devices	Premier Elite SmartKey™	Expanders	Devices	Premier Elite SmartKey™
Premier Elite 24™	1	16	16	2	16	25
Premier Elite 48™	1	32	16	4	32	50
Premier Elite 48-W™	N/A	32	16	N/A	N/A	N/A
Premier Elite 88™	2	64	32	8	64	100
Premier Elite 168™	4	128	64	16	128	200
Premier Elite 640™	16	512	256	16	128	256



NOTE Premier Elite 32XP-W take 4 address slots on the network, Premier Elite 8XP-W take one address

To enable all of the advanced functionality and diagnostics capability **Ricochet™** MT2 the following are minimum requirements:-

- **Wintex™** Version 6 Build 16 or later
- **Ricochet Monitor™** 0.2.15.00 or later
- **Premier Elite™ Series** V2.xx or later
- **Premier Elite™ 32XP-W & 8-W** Expanders V2.xx or later

System Design Considerations

To ensure correct setup and operation of the Wireless Network it is important that the following procedures are used when learning and placing devices.

Multiple Expander Systems Ricochet MT2

When using multiple expanders great care should be taken when designing the system. Each expander should be treated as its own wireless network; it is not possible for devices to hop from one wireless network to the other, it is also not possible for expanders to pass wireless signals from devices not assigned to them and nor can the expanders talk to each other.

Learning Devices

All devices should be learnt **before** they are placed in their final location. The expander should be in commission mode, please see INS467 for details. This will ensure that they are registered on the receiver or control panel, and that Mesh Networks and routing are

established correctly. Please refer to the relevant section in this document to Learn Devices to the system.

Learning Premier Elite SmartKey™

On Ricochet MT2 systems **Premier Elite SmartKey™** should only be learned **AFTER** all devices and expanders are in their final location, this is critical on larger systems where multiple expanders are being used



NOTE Devices should be at least 30cm's away from the receiver when being learned.

Placing Devices

Once all of the devices have been learnt, they will need placing in their desired location, this should be done by installing devices closest to the expander first and then working outwards so that the last devices installed are those furthest away from the expander.

Make sure to install devices with the expander in Commission mode. See INS467 for details

Devices also have a commission mode which will indicate a secure and valid path of communication to the receiver. See INS467 for details



NOTE You should wait at least 15 minutes after installing the last device to make sure routing has been correctly established between all system devices.



NOTE For maximum reliability and system integrity avoid long and thin set-ups.

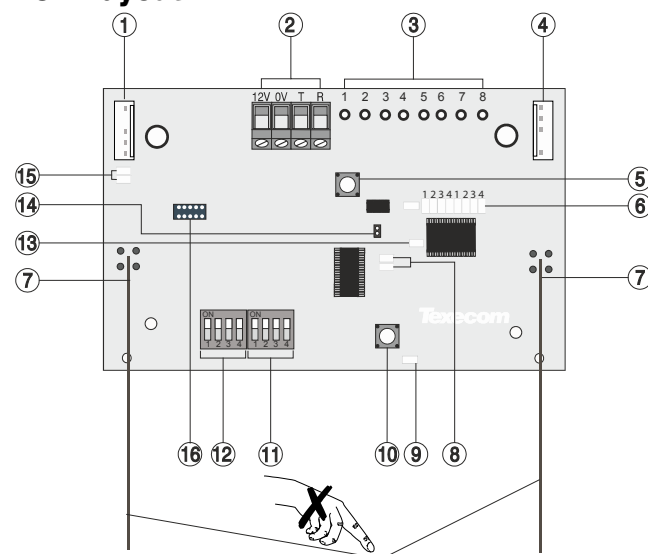

NOTE Devices are capable of hopping through up to two other devices, or a maximum of three hops.

PCB Layout

1: Engineers Keypad Connection

An engineer's keypad (*Premier/Elite LCD keypad and interface lead*) can be temporarily plugged onto this connector to allow system programming and testing. (Functions dependent on Panel firmware version) Set the keypad address switches to all on.

2: Network Connection

The + and – terminals provide power whilst the T and R terminals are transmit and receive data.

3: For Future Use

4: Comm. Port Connection

Serial communications port for connecting the 8 XP-W & 32XP-W to a PC via PC Com/USB Com or Com IP for use with **RICOCHET™** Monitor Software.

5: Lid Tamper

When open puts the system into commission mode and digitally attenuates the receiver signal by 15Db.

6: Programming LED's

Allows programming of devices directly to the receiver, in conjunction with the learn switch.

7: Antenna

RF Antenna.

Premier 32XP-W = 2 x Antenna

Premier 8XP-W = 1 x Antenna

8: Network LED's

Green LED = Data received by the expander from the panel Red LED = Data transmitted by the expander to the panel. (*The flash rate depends on the mode and RF activity*)

9: Heartbeat LED

Flashes steadily to indicate that the receiver is functioning correctly. If the light is ON or OFF all the time, then there could be a hardware problem.

10: Learn Switch

To be used with programming LED's to learn devices directly to the receiver.

11: Options Switch

Use to select the receiver functionality depending on panel firmware.

Switch 1 ON =firmware dependant, please see the relevant programming section.

Switch 2 ON = Legacy Mode

OFF = **RICOCHET™**

Switch 3 ON = Impaq Contact-W Wired Input 2 will report as Tamper (*default*)

OFF = input 2 will report as an Alarm.

Switch 4 Walk test

12: Address Switch

Used to assign the address of the receiver on the premier network

13: RF LED

Flashes when transmitting or receiving RF data

14: Tamper Disable

Disables the lid and rear tamper

15: Engineer's Keypad LED's

Red LED flashes constantly, the flash rate increases when data is being transmitted.

16: Flash Programming Port

Variant dependent, for flashing the expander with updated firmware.

Ricochet MT2 Expander Addressing

Introduction

The address range and switch position will depend on which combination of expanders are being used. Each 32XP-W takes up 4 address slots on the control panel network, however the network slots are virtual until devices are assigned to available zones. It is possible that if a 32XP-W is being used at Address 1, but only 16 devices have been used, Address 3 & 4 are available for hardwired 8XP's or 8XP-W's.

Please see some examples of mixing different types of Expanders on various Elite panels and the addressing requirements.

Example 1 Totally wireless system(s)

Panel	32XP-W															
	Network 1		Network 2		Network 3		Network 4		Network 5		Network 6		Network 7		Network 8	
Expanders (Max)	2		2		2		2		2		2		2		2	
Premier Elite 88™	Exp 1	Exp 2	N/A	N/A	N/A	N/A	N/A	N/A	N/A	N/A	N/A	N/A	N/A	N/A	N/A	N/A
Expander Address	1	5	N/A	N/A	N/A	N/A	N/A	N/A	N/A	N/A	N/A	N/A	N/A	N/A	N/A	N/A
Premier Elite 168™	Exp 1	Exp 2	Exp 1	Exp 2	N/A	N/A	N/A	N/A	N/A	N/A	N/A	N/A	N/A	N/A	N/A	N/A
Expander Address	1	5	1	5	N/A	N/A	N/A	N/A	N/A	N/A	N/A	N/A	N/A	N/A	N/A	N/A
Premier Elite 640™	Exp 1	Exp 2	Exp 1	Exp 2	Exp 1	Exp 2	Exp 1	Exp 2	Exp 1	Exp 2	Exp 1	Exp 2	Exp 1	Exp 2	Exp 1	Exp 2
Expander Address	1	5	1	5	1	5	1	5	1	5	1	5	1	5	1	5

Example 2 Premier Elite 168™, + 32XP-W, 8XP-W's & 8XP's mix

Panel	Network 1				Network 2			
	Expanders (Wireless)				Expanders (Mixed)			
Premier Elite 168™	32XP-W				8XP-W			
Expander Address	1				1			
Devices (Max)	32				8			
Premier Elite SmartKey™ (Max)	16				16			
	2 x 8XP-W				8XP			
Expander Address	5 & 6				2			
Devices (Max)	16				8			
	16				N/A			

Example 3 Premier Elite™ 48, 32XP-W + 8XP's

Panel	Network 1	
	Expanders (Mixed)	
Premier Elite 48™	32XP-W	2 x 8XP
Expander Address	1	5 & 6
Devices Used	16	16
Premier Elite SmartKey™ (Max)	16	N/A

8XE Zone Expander (24 Only)

The 8XE Zone Expander has:

- 8 fully programmable zones
- Aux 12V Output

Expander Layout

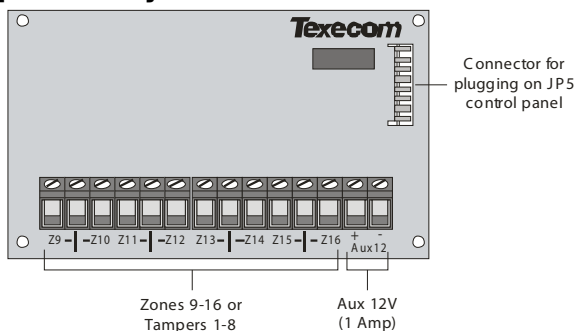

Connecting Expanders

The 8XE local zone expander plugs directly on to the terminals located on the right hand side of the control panel (see below for details). To install the local zone expander proceed as follows:

1. Ensure that all power is removed from the control panel (mains and battery) before attempting to fit the expander.
2. Push the four support pillars (supplied) into the four locating holes on the control panel PCB.
3. Align the local expander connector with the 8 way plug (JP5) on the control panel. Push expander into place, ensuring that all four pillars clip into the four locating holes on the local expander.

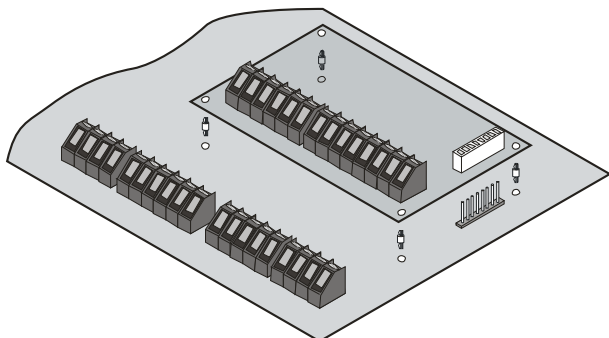

Zone Numbering

The table below shows the zone allocation when the expanders are installed:

Configuration	Panel Zones	Expander Zones
8XE = Zones	1 to 8	9 to 16
8XE = Tampers	1 to 8	Tampers 1 to 8

Expander Zones

The expander has eight programmable zones (see page 31 for wiring details). Each zone is also fully programmable (see page 48 for programming details).

8XP Zone Expander

Expander Layout

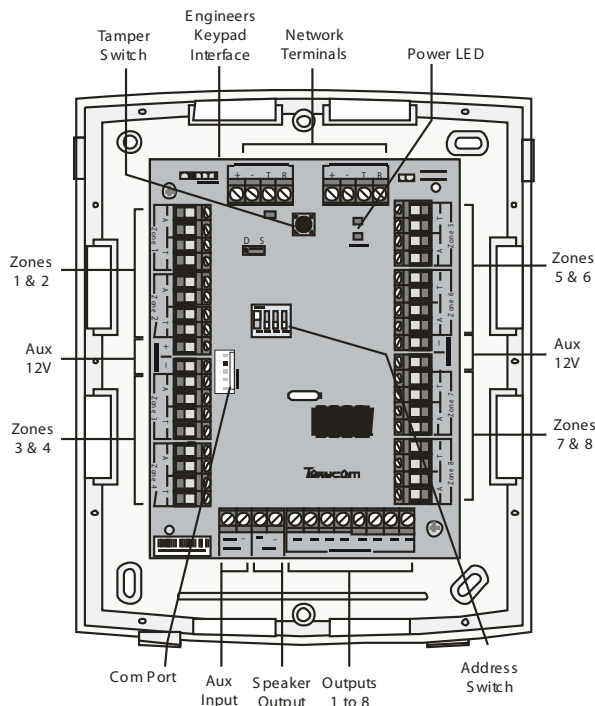

Connecting Expanders

Expanders are connected to the network terminals located at the bottom of the control panel (see pages 20 & 21 for details).

Expander Addressing

Each Expander must be assigned a different address using the DIL switches located in the centre of the PCB. The table below shows the expander addressing:

Address	DIL 1	DIL 2	DIL 3	DIL 4	
1*	On or off	Off	Off	Off	
2*	Off	On	Off	Off	
3**	Off	Off	On	Off	
4**	Off	Off	Off	On	
5***	On	Off	Off	On	
6***	Off	On	Off	On	
7***	Off	Off	On	On	
8***	On	Off	On	On	



Never set two expanders on the same network to the same address.

* 24/48/88/168/640

** 48/88/168/640 only

*** 88 168 & 640 only

Expander Zones

The expander has eight programmable zones (see page 31 for wiring details). Each zone is also fully programmable (see page 48 for details).

Star and Daisy Jumper Option

The PCB has a jumper JP3 which allows you to select either STAR (S) or DAISY (D) wiring configuration. The jumper should be set as follows:



If the network IN connection is wired in parallel with any other device the jumper **MUST** be set to the **S** position. All previous versions of the expander operated in this mode and for backward compatibility the unit is supplied with the jumper in this position.



If the network IN connection is only wired to one device the jumper should be set to the **D** position.

When the jumper is set to the STAR position the network data signals are not boosted between expander and the previous device. In this mode the network cabling **MUST** not exceed 100m between devices. When the jumper is set to the DAISY position the network data signals are boosted between the expander and the previous device. This mode will allow expanders on the network to be connected up to 250m apart and **MUST** only be selected if the expander has one device connected to the network "IN" connections.

Star wiring example

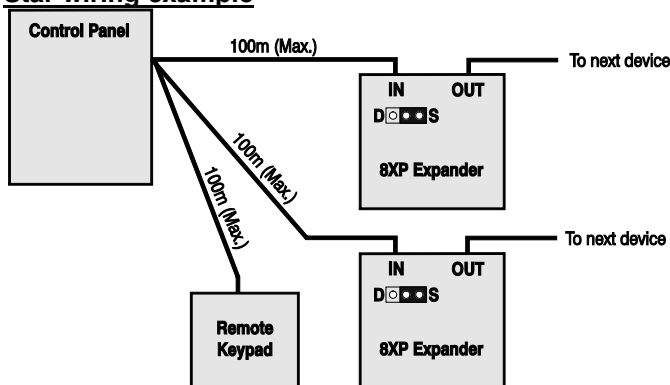

Daisy chain wiring example

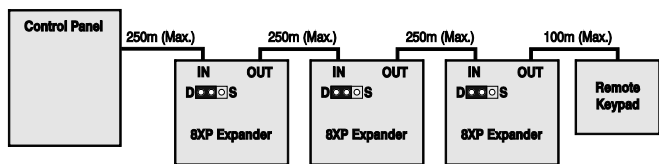

Combined Wiring example

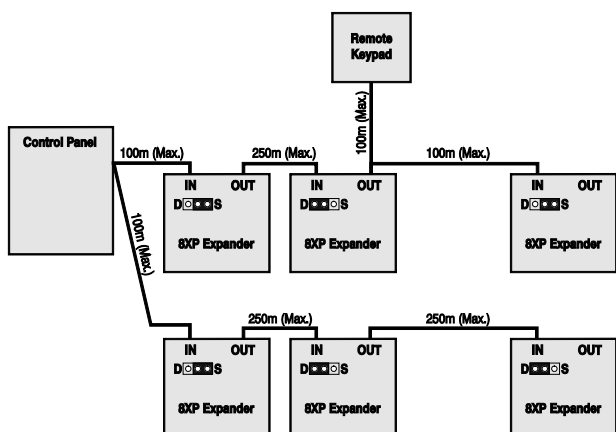

Zone Numbering (24/48/88/168)

The table below shows the zone allocation when the expanders are installed:

Address	Zones (Network 1)	Zones (Network 2)
1*	9 - 16	73 - 80
2*	17 - 24	81 - 88
3**	25 - 32	89 - 96
4**	33 - 40	97 - 104
5***	41 - 48	105 - 112
6***	49 - 56	113 - 120
7***	57 - 64	121 - 128
8***	65 - 72	129 - 136

NOTE Network 2 can only be used on the 168.

NOTE For 640 see page 30

* 24/48/88/168/640

** 48/88/168/640 only

*** 88 168 & 640 only

Expander Auxiliary Input

The expander has one programmable input. This auxiliary input can be used to monitor auxiliary devices such as tamper loops etc. Wire as per Aux Tamper shown on page 32 (see page 75 for details). The system will respond as follows:

Input Status	System Response
0V Applied	Input Secure
0V Removed	Input Active
EOL	Various *

NOTE For further details on how the input status affects the system please refer to page 75.

* For wiring details, see page 35.

Expander Outputs

The zone expander has eight programmable outputs, which can be used to drive auxiliary devices such as LED's, sounders or relays etc. Wire as per Panel Outputs shown on page 34 (see page 76 for details). The electrical characteristics for the outputs are shown below:

Outputs	Max Current	Type
1 to 8	100mA	Switched -ve

Expander Speaker Output

The expander has an output that can be used for driving up to one 16Ω or two 8Ω loudspeakers (see page 33 for details).

Expander Com Port

The Com Port can be used to connect a **PSU200** or amonitored power supply.

Expander Lid Tamper

The lid tamper of each expander can be disabled if required by fitting a jumper link across the centre and right hand pins of the 'Enable Tamper' pins (JP2) leaving the left hand pin free. These pins are located to the left of the address DIL switch just beneath the fuse.

iProx Module

iProx Layout

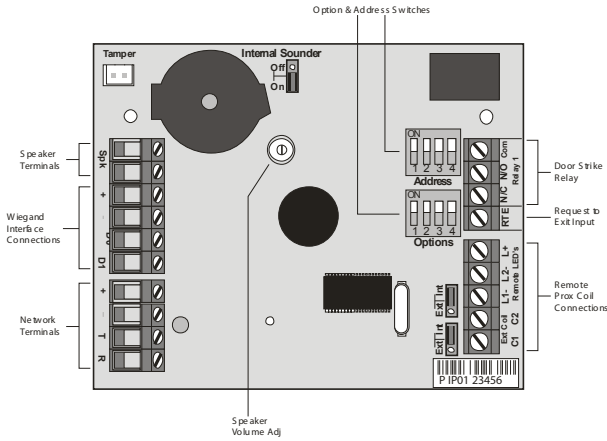

Connection

The **iProx Module** is connected to the network terminals located at the bottom of the control panel (see pages 20 & 21 for details).

Addressing

The **iProx Module** is addressed as a keypad and will occupy a keypad slot on the network. The unit must have a unique address, which must not conflict with keypad or any other **iProx Module** on the same network.

The following table shows the addressing:

Address	DIL 1	DIL 2	DIL 3	DIL 4	
1	On or off	Off	Off	Off	
2	Off	On	Off	Off	
3	Off	Off	On	Off	
4	Off	Off	Off	On	
5*	On	Off	Off	On	
6*	Off	On	Off	On	
7*	Off	Off	On	On	
8*	On	Off	On	On	

NOTE Never set two modules on the same network to the same address.

*88/168 & 640 only

Refer to the **iProx Module** manual for programming and operating instructions.

60iXD Zone Expander

The **60iXD** expander provides the following facilities:

- Two iD loops each supporting up to 30 biscuits
- Fused 12V output for powering detectors
- Engineer's keypad port for local iD diagnostics

OP16 Output Expander

Output Module Layout

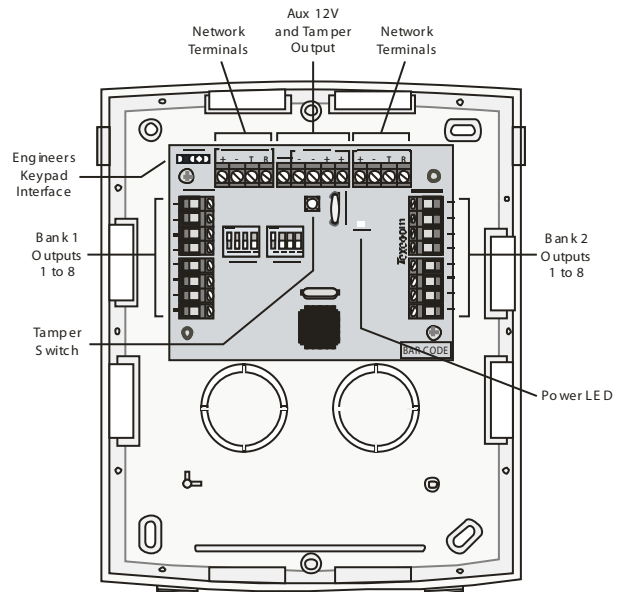

Connecting Output Modules

Output modules are connected to the network terminals located at the bottom left hand corner of the control panel (see pages 20 & 21 for details).

Output Module Addressing

Each output module must be assigned a different address using the DIL switches located in the centre of the PCB.

The table below shows the expander addressing:

Address	DIL 1	DIL 2	DIL 3	DIL 4	
1	On or off	Off	Off	Off	
2	Off	On	Off	Off	
3*	Off	Off	On	Off	
4*	Off	Off	Off	On	
5**	On	Off	Off	On	
6**	Off	On	Off	On	
7**	Off	Off	On	On	
8**	On	Off	On	On	

* 88 and 168 only

** 168 only

NOTE In order for an output module to mimic zone expander outputs, the output module must be addressed the same as the zone expander that it is mimicking.

Any combination of addresses can be used on each output module i.e. Bank 1 can be addressed to mimic expander 3 and Bank 2 can be addressed to mimic expander 8.

Bank 1 switch sets the address of the device that Bank 1 outputs 1 to 8 will mimic.

Bank 2 switch sets the address of the device that Bank 2 outputs 1 to 8 will mimic.

Output Module Numbering

The table below shows the output allocation when the output modules are installed,

Address	Outputs (Network 1)	Outputs (Network 2) **
1	Expander 1, 1 - 8	Expander 1, 1 - 8
2	Expander 2, 1 - 8	Expander 2, 1 - 8
3 *	Expander 3, 1 - 8	Expander 3, 1 - 8
4 *	Expander 4, 1 - 8	Expander 4, 1 - 8
5 **	Expander 5, 1 - 8	Expander 5, 1 - 8
6 **	Expander 6, 1 - 8	Expander 6, 1 - 8
7 **	Expander 7, 1 - 8	Expander 7, 1 - 8
8 **	Expander 8, 1 - 8	Expander 8, 1 - 8

NOTE Network 2 can only be used on the 168

* 88 and 168 only

** 168 only

for 640 see page 30

Outputs

The output module has 16 programmable outputs, which can be used to drive auxiliary devices such as LED's, sounders or relays etc. Wire as per Panel Outputs shown on page 34 (see page 76 for details). The electrical characteristics for the outputs are shown below:

Bank	Outputs	Max Current	Type
1	1 to 8	100mA	Switched -ve
2	1 to 8	100mA	Switched -ve

Tamper Output

The tamper switch on the output module is connected to the tamper output at the top of the module. If monitoring of the lid tamper is required, this output must be connected to a suitable input on the control panel or zone expander.

RM8 Relay Module

The Premier Elite RM8 Relay Module is compatible with any control panels that have a plug on RedCARE/Dualcom footprint.

Features

- 8 relay outputs (12V, 3Amp each)
- 8 Auxiliary inputs (-ve applied)
- Auxiliary 12V output (protected by a 1 Amp fuse)
- Relay ON indication via LED's

PCB Layout

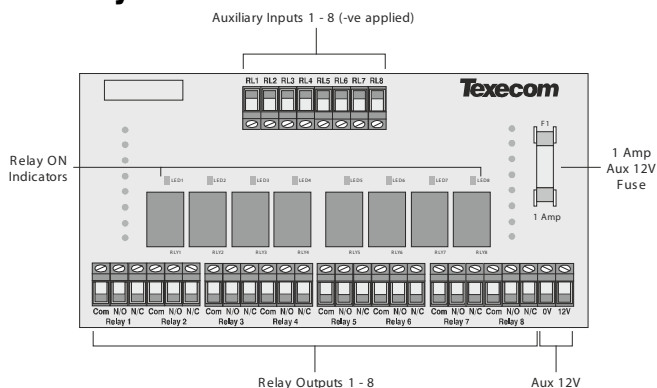

Installation

Before attempting to install the RM8 Relay Module, isolate ALL power from the control panel (AC Mains and Battery). Do not continue if there is power still present on the control panel.

NOTE Plugging on the Relay Module with power still present on the control panel may damage the Relay Module, control panel or both and invalidate any warranty.

Plugging on the Relay Module

1. Ensure that the Relay Module is the correct way up (see page **Error! Bookmark not defined.**).
2. Gently press down on the Relay Module until the relay Module is seated correctly.
3. Reconnect power to the control panel.

Testing on the Relay Module

1. For plug on operation, test the Relay Module in accordance with the control panel instructions.
2. To test the auxiliary inputs, apply 0V to each input in turn and ensure that the correct LED illuminates and a click is heard from the relay.

Connecting Outputs

The RM8 Relay Module has 8 outputs. These outputs can be used to drive auxiliary devices such as LED's, sounders or communicators etc. Each output is a clean contact relay rated at 3A @ 12V. The diagram below shows typical wiring examples for the outputs:

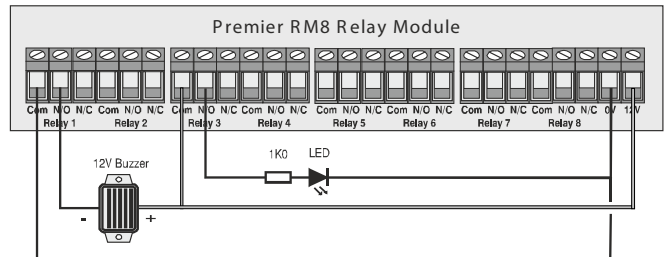

Connecting Inputs

The RM8 Relay Module has 8 auxiliary inputs. These inputs can be used to activate the relays from an external source. Each input is -Ve applied and draws up to 30mA. The diagram below shows typical wiring examples for the inputs:

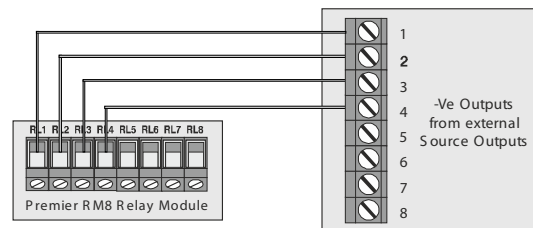

Zone and Output Numbering 24/48/88/168

Expander Zones

Address	Zones (Network 1)	Zones (Network 2)
1	9 - 16	73 - 80
2	17 - 24	81 - 88
3	25 - 32	89 - 96
4	33 - 40	97 - 104
5	41 - 48	105 - 112
6	49 - 56	113 - 120
7	57 - 64	121 - 128
8	65 - 72	129 - 136

Keypad Zones

Address	Zones Network 1	Zones Network 2
1	Unmapped	Unmapped
2	Unmapped	Unmapped
3	Unmapped	Unmapped
4	Unmapped	Unmapped
5	Unmapped	Unmapped
6	Unmapped	Unmapped
7	Unmapped	Unmapped
8	Unmapped	Unmapped

Keypad Zones

Address	Zones Network 1	Zones Network 2	Zones Network 3	Zones Network 4	Zones Network 5	Zones Network 6	Zones Network 7	Zones Network 8
1	Unmapped	Unmapped	Unmapped	Unmapped	Unmapped	Unmapped	Unmapped	Unmapped
2	Unmapped	Unmapped	Unmapped	Unmapped	Unmapped	Unmapped	Unmapped	Unmapped
3	Unmapped	Unmapped	Unmapped	Unmapped	Unmapped	Unmapped	Unmapped	Unmapped
4	Unmapped	Unmapped	Unmapped	Unmapped	Unmapped	Unmapped	Unmapped	Unmapped
5	Unmapped	Unmapped	Unmapped	Unmapped	Unmapped	Unmapped	Unmapped	Unmapped
6	Unmapped	Unmapped	Unmapped	Unmapped	Unmapped	Unmapped	Unmapped	Unmapped
7	Unmapped	Unmapped	Unmapped	Unmapped	Unmapped	Unmapped	Unmapped	Unmapped
8	Unmapped	Unmapped	Unmapped	Unmapped	Unmapped	Unmapped	Unmapped	Unmapped

Expander/OP16 Outputs

Address	Outputs Network 1	Outputs Network 2	Outputs Network 3	Outputs Network 4	Outputs Network 5	Outputs Network 6	Outputs Network 7	Outputs Network 8
1	Exp. 1, 1-8	Exp. 1, 1-8	Exp. 1, 1-8	Exp. 1, 1-8	Exp. 1, 1-8	Exp. 1, 1-8	Exp. 1, 1-8	Exp. 1, 1-8
2	Exp. 2, 1-8	Exp. 2, 1-8	Exp. 2, 1-8	Exp. 2, 1-8	Exp. 2, 1-8	Exp. 2, 1-8	Exp. 2, 1-8	Exp. 2, 1-8
3	Exp. 3, 1-8	Exp. 3, 1-8	Exp. 3, 1-8	Exp. 3, 1-8	Exp. 3, 1-8	Exp. 3, 1-8	Exp. 3, 1-8	Exp. 3, 1-8
4	Exp. 4, 1-8	Exp. 4, 1-8	Exp. 4, 1-8	Exp. 4, 1-8	Exp. 4, 1-8	Exp. 4, 1-8	Exp. 4, 1-8	Exp. 4, 1-8
5	Exp. 5, 1-8	Exp. 5, 1-8	Exp. 5, 1-8	Exp. 5, 1-8	Exp. 5, 1-8	Exp. 5, 1-8	Exp. 5, 1-8	Exp. 5, 1-8
6	Exp. 6, 1-8	Exp. 6, 1-8	Exp. 6, 1-8	Exp. 6, 1-8	Exp. 6, 1-8	Exp. 6, 1-8	Exp. 6, 1-8	Exp. 6, 1-8
7	Exp. 7, 1-8	Exp. 7, 1-8	Exp. 7, 1-8	Exp. 7, 1-8	Exp. 7, 1-8	Exp. 7, 1-8	Exp. 7, 1-8	Exp. 7, 1-8
8	Exp. 8, 1-8	Exp. 8, 1-8	Exp. 8, 1-8	Exp. 8, 1-8	Exp. 8, 1-8	Exp. 8, 1-8	Exp. 8, 1-8	Exp. 8, 1-8

Zone and Output Numbering 640

Expander Zones

Address	Zones Network 1	Zones Network 2	Zones Network 3	Zones Network 4	Zones Network 5	Zones Network 6	Zones Network 7	Zones Network 8
1	1 - 8	65 - 72	129 - 136	193 - 200	257 - 264	321 - 328	385 - 392	449 - 456
2	9 - 16	73 - 80	137 - 144	201 - 208	265 - 272	329 - 336	393 - 400	457 - 464
3	17 - 24	81 - 88	145 - 152	209 - 216	273 - 280	337 - 344	401 - 408	465 - 472
4	25 - 32	89 - 96	153 - 160	217 - 224	281 - 288	345 - 352	409 - 416	473 - 480
5	33 - 40	97 - 104	161 - 168	225 - 232	289 - 296	353 - 360	417 - 424	481 - 488
6	41 - 48	105 - 112	169 - 176	233 - 240	297 - 304	361 - 368	425 - 432	489 - 496
7	49 - 56	113 - 120	177 - 184	241 - 248	305 - 312	369 - 376	433 - 440	497 - 504
8	57 - 64	121 - 128	185 - 192	249 - 256	313 - 320	377 - 384	441 - 448	505 - 512

Keypad Zones

Address	Zones Network 1	Zones Network 2	Zones Network 3	Zones Network 4	Zones Network 5	Zones Network 6	Zones Network 7	Zones Network 8
1	Unmapped	Unmapped	Unmapped	Unmapped	Unmapped	Unmapped	Unmapped	Unmapped
2	Unmapped	Unmapped	Unmapped	Unmapped	Unmapped	Unmapped	Unmapped	Unmapped
3	Unmapped	Unmapped	Unmapped	Unmapped	Unmapped	Unmapped	Unmapped	Unmapped
4	Unmapped	Unmapped	Unmapped	Unmapped	Unmapped	Unmapped	Unmapped	Unmapped
5	Unmapped	Unmapped	Unmapped	Unmapped	Unmapped	Unmapped	Unmapped	Unmapped
6	Unmapped	Unmapped	Unmapped	Unmapped	Unmapped	Unmapped	Unmapped	Unmapped
7	Unmapped	Unmapped	Unmapped	Unmapped	Unmapped	Unmapped	Unmapped	Unmapped
8	Unmapped	Unmapped	Unmapped	Unmapped	Unmapped	Unmapped	Unmapped	Unmapped

Expander/OP16 Outputs

Address	Outputs Network 1	Outputs Network 2	Outputs Network 3	Outputs Network 4	Outputs Network 5	Outputs Network 6	Outputs Network 7	Outputs Network 8
1	Exp. 1, 1-8	Exp. 1, 1-8	Exp. 1, 1-8	Exp. 1, 1-8	Exp. 1, 1-8	Exp. 1, 1-8	Exp. 1, 1-8	Exp. 1, 1-8
2	Exp. 2, 1-8	Exp. 2, 1-8	Exp. 2, 1-8	Exp. 2, 1-8	Exp. 2, 1-8	Exp. 2, 1-8	Exp. 2, 1-8	Exp. 2, 1-8
3	Exp. 3, 1-8	Exp. 3, 1-8	Exp. 3, 1-8	Exp. 3, 1-8	Exp. 3, 1-8	Exp. 3, 1-8	Exp. 3, 1-8	Exp. 3, 1-8
4	Exp. 4, 1-8	Exp. 4, 1-8	Exp. 4, 1-8	Exp. 4, 1-8	Exp. 4, 1-8	Exp. 4, 1-8	Exp. 4, 1-8	Exp. 4, 1-8
5	Exp. 5, 1-8	Exp. 5, 1-8	Exp. 5, 1-8	Exp. 5, 1-8	Exp. 5, 1-8	Exp. 5, 1-8	Exp. 5, 1-8	Exp. 5, 1-8
6	Exp. 6, 1-8	Exp. 6, 1-8	Exp. 6, 1-8	Exp. 6, 1-8	Exp. 6, 1-8	Exp. 6, 1-8	Exp. 6, 1-8	Exp. 6, 1-8
7	Exp. 7, 1-8	Exp. 7, 1-8	Exp. 7, 1-8	Exp. 7, 1-8	Exp. 7, 1-8	Exp. 7, 1-8	Exp. 7, 1-8	Exp. 7, 1-8
8	Exp. 8, 1-8	Exp. 8, 1-8	Exp. 8, 1-8	Exp. 8, 1-8	Exp. 8, 1-8	Exp. 8, 1-8	Exp. 8, 1-8	Exp. 8, 1-8

Zone Connections

Any zones that are not being used must be linked out or programmed as 'Not Used' (see page 48 for details).

When using End Of Line wiring, only 1 device should normally be connected to each zone.

A zone short can be programmed for 'Active' or 'Tamper' response (see page 64 for details).

End Of Line (EOL)

Use this wiring configuration when connecting normally closed detection devices to the zone using 2-Wires. Zone wiring should be programmed as Double Pole/EOL (see **Zone Wiring** page 53)

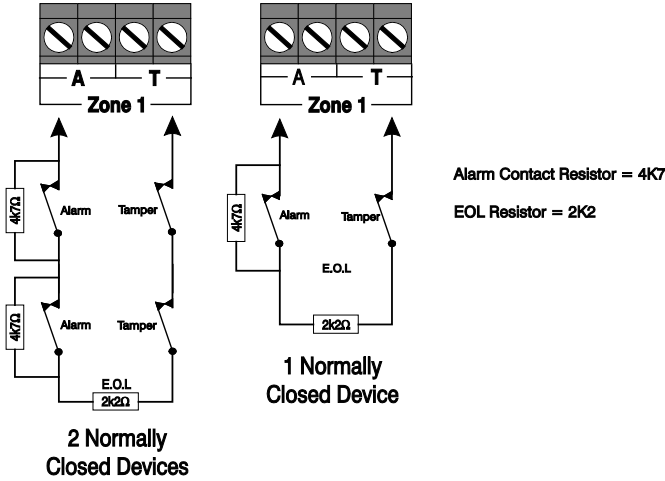

NOTE When using this configuration, no more than 3 detectors can be connected to each zone.

Double Pole

Use this wiring configuration when connecting normally closed or normally open detection devices to the zone using 4-Wires. Zone wiring should be programmed as Double Pole/EOL (see **Zone Wiring** page 53)

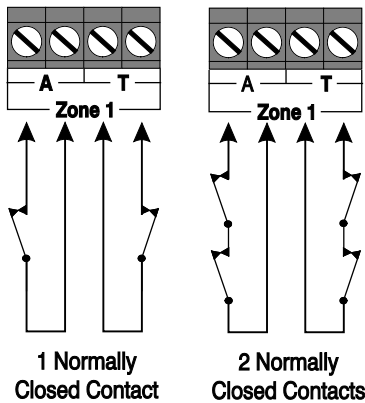

NOTE When using this configuration, no more than 10 detectors can be connected to each zone.

Triple End Of Line (TEOL)

Use this wiring configuration when connecting PIR devices with that require Anti Mask and Fault detection. Several zone wiring programming options are available for this, Triple EOL is illustrated below. See **Zone Wiring** on page 53.

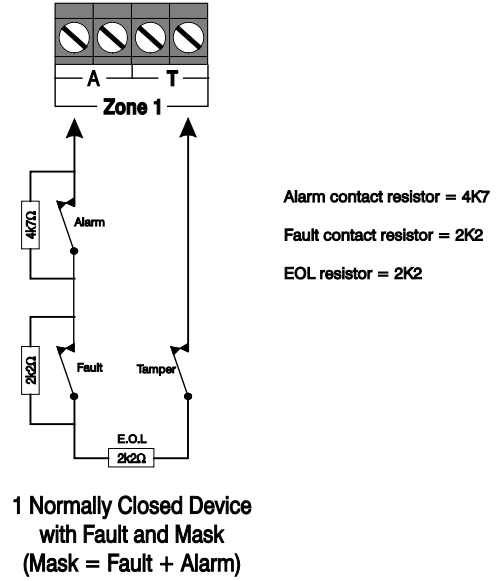

NOTE When using this configuration, only 1 detector can be connected to each zone.

NOTE Alternative resistor values are available – see **Zone Wiring** on page 53 for more details.

Normally Open Or Normally Closed Circuits

This wiring configuration is normally used for key switches with a N/O

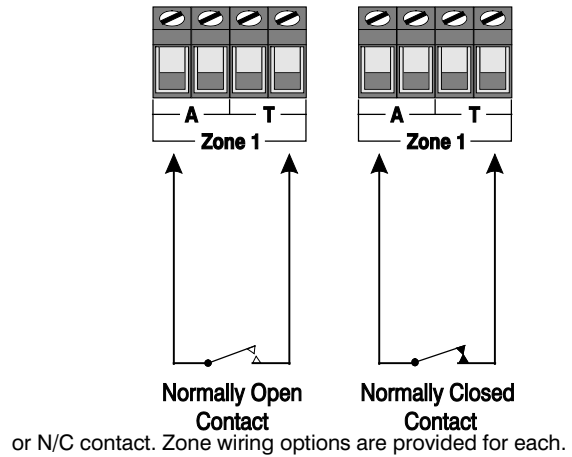

Testing Zones

To test zones prior to commissioning, use the **View Zone Status** option in **Engineers Utilities** see page 116.

60iXD Zone Expander

The 60iXD expander provides the following facilities:

- Two iD loops each supporting up to 30 biscuits
- Fused 12V output for powering detectors
- Engineer's keypad port for local iD diagnostics

Installation

Before connecting the 60iXD expander module, isolate ALL power from the control panel (AC mains and battery), do not continue if there is still power present on the control panel.

1. Connect the iD expander to the control panel, see 60iXD installation manual (INS261) for details.
2. Connect the iD devices to the expander module, see "iD Connections".
3. Reapply power to the control panel and program the necessary options on the panel see 60iXD installation manual (INS261) for details.

iD Connections

Each iD biscuit is connected across a two-wire detector loop. Apart from observing the correct polarity, any wiring configuration can be used, as shown in the diagram below:

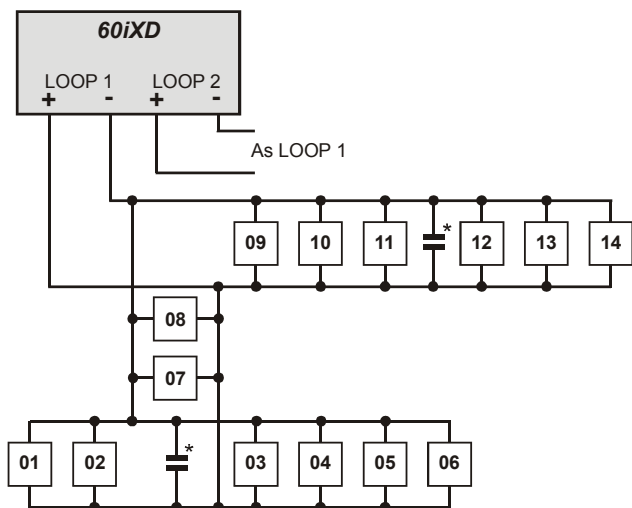

* The 60iXD expander module is supplied with 4 off 10nF capacitors in the spares pack. It is recommended that you connect a 10nF capacitor approximately at the half way point of each iD spur. It is especially important to do this on iD spurs that are less than 30 metres.

Cabling Considerations

The iD loop can be wired using standard 4-core alarm cable, this allows 2 cores to be used for the iD biscuit and 2 cores for supplying 12V power for PIR's etc.

The number of biscuits that can be connected per cable run is determined by the impedance of the cable used. Standard 4-core alarm cable (7/0.2mm) has a resistance of approximately 8 Ohms per 100 metres. The following table shows the maximum number of biscuits that can be connected at the end of a single cable run using standard 4-core alarm cable:

Cable Length	Maximum Number of Biscuits
100m	30
200m	15
400m	7
800m	3

If a different type of cable is used, the distances should be re-calculated. e.g., if 7/0.4mm cable is used, a single run of 200m would support 30 devices on the end as the resistance of the cable is halved.

When installing the iD loop it is usually more practical to run several cables from the expander module to the different areas of protection. This effectively reduces any distance problems and makes fault finding much easier.

To reduce the risk of induced interference and wherever possible, cables should not be positioned along side mains power, telephone or other data transmission cables, or run within the same ducting or trunking as any other cables.

The wiring for the system's internal sounders (loudspeakers) should not be connected in the same multi-core as the iD loop.

Biscuit Connections

Each iD biscuit is identified by its own number 01 to 30 and contains its own internal sensor that is continuously monitored by the expander module. The diagram below shows the connections to the biscuit for monitoring both tamper and alarm contacts.

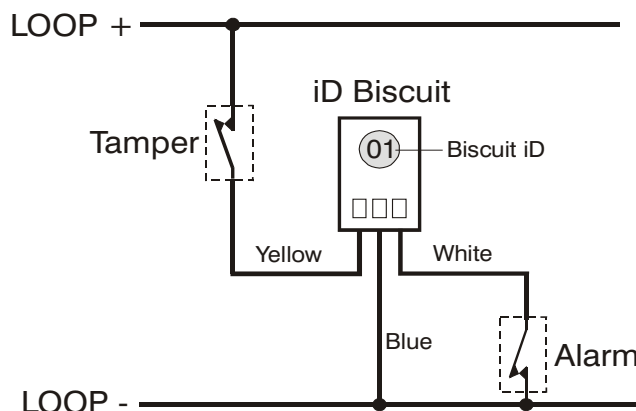

When the tamper switch is opened, the iD biscuit is taken offline and a tamper condition is generated by the control panel. If the alarm switch is opened the biscuit's internal sensor changes state and the control panel will see this as an active condition and will respond as appropriate.

The diagram below shows the typical wiring of a biscuit to a standard PIR.

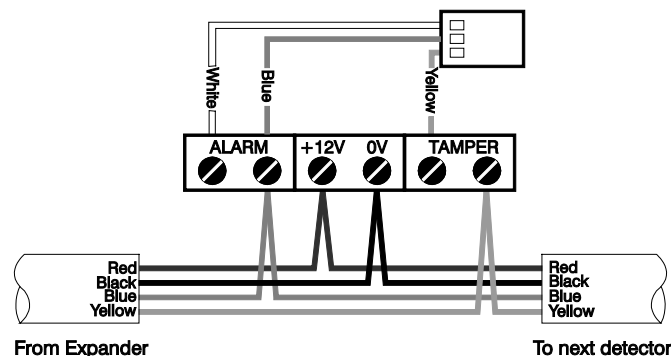

"iD" is a registered trade mark of Chloride Safety System Limited.

Auxiliary/Fault Connections

The Aux/Fault terminals allow the control panel to monitor the tamper & fault loops of external devices such as power supplies etc.

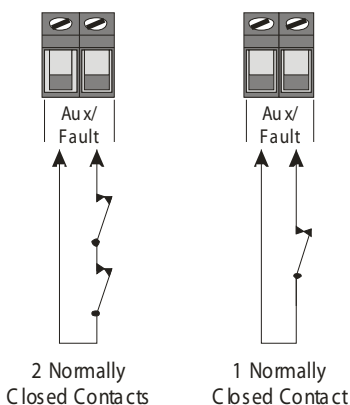

NOTE If the 'Aux/Fault' terminals are not being used they must be linked out.

Speaker Connections

This output can be used for driving up to one 16Ω or two 8Ω loudspeakers as shown below:

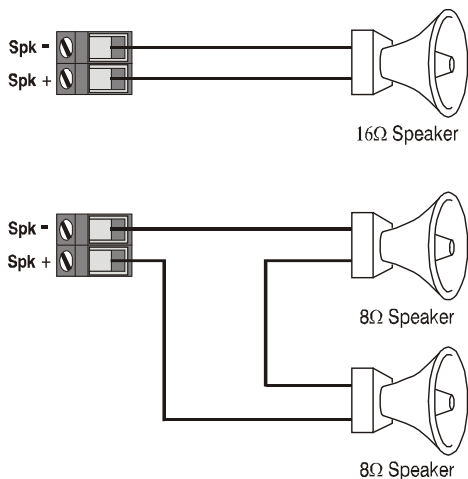

NOTE For details on testing Speaker outputs, see page 113.

External Sounder Connections

The following terminals have been provided for connection to an external sounder:

- (A) +12V**
12V supply (protected by a 1A fuse F4). Normally connected to '+12V' on the sounder.
- (B) Bell -**
Sounder output, switches to 0V in alarm (SAB) and is rated at 500mA. Normally connected to Trigger -ve on the sounder. This output can also be programmed for SCB operation (see page 63 for details).
- (C) Tamp**
Negative tamper return. Normally connected to 'Tamper Out' on the sounder. If this terminal is not being used, it must be connected to '0V'.
- (D) 0V**
0V supply. Normally connected to '0V' on the sounder.

(S) Strb -
Strobe output, switches to 0V in alarm and is rated at 500mA. Normally connected to strobe -ve on the sounder (where applicable, connect the strobe +ve to +12V).

NOTE For EN50131 & INCERT installations the Bell & Aux Tamper must be wired to a zone.

Grade 2 Installation

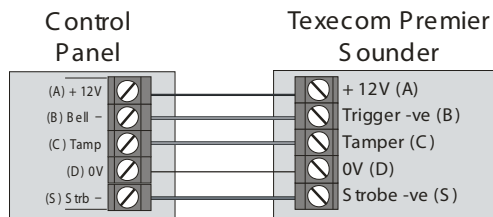

Grade 3 Installation

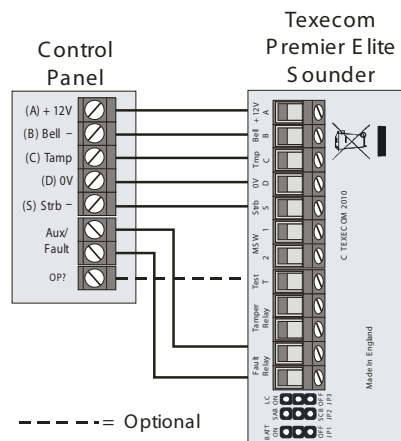

NOTE The Aux/Fault relay should be programmed as Fault

Grade 3 Installation (Using a Zone)

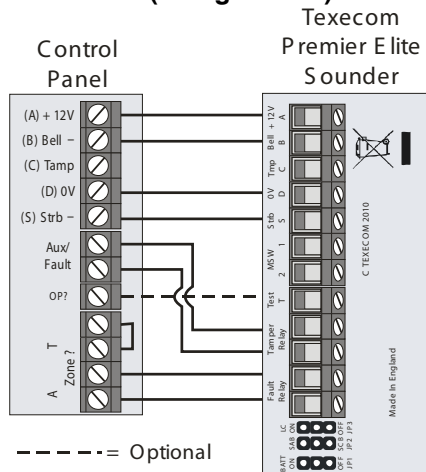

- Aux/Fault -**
Wire the Sounder Tamper Relay to these terminals
- Zone ? -**
Wire the Sounder Fault Relay to any Zone, looping out the Tamper connection. The zone should be programmed as "Auxiliary" see page 50 and the wiring type set as "WD Monitor" see page 53
- OP ? (Optional)**
Use a panel output wired to the Test terminal and programmed as "WD Test Active" see page 78. This will allow activation of the Test Mode remotely from the Diagnostics function in Wintex.

NOTE For details on testing the 'Bell' outputs, see page 113

Panel Outputs

The control panel has five programmable outputs, which can be used to drive auxiliary devices such as LED's, sounders or relays etc. (see page 76 for details). The table below shows the electrical characteristics for each output:

No	Max Current	Type
1	500mA	Switched -ve
2	500mA	Switched -ve
3 **	500mA	Switched +ve
4 **	500mA	Switched +ve
5 **	3A	Relay

NOTE ** 88/168 & 640 only

Wiring Outputs

The diagram below shows some typical wiring examples:

-ve Applied Outputs

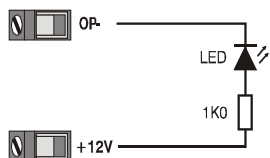

+ve Applied Outputs

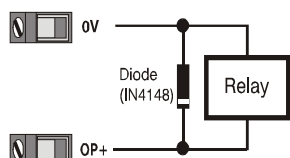
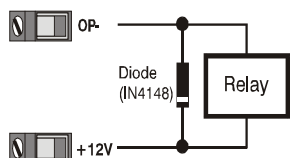
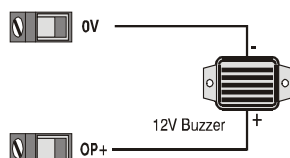
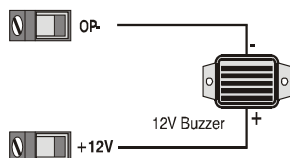
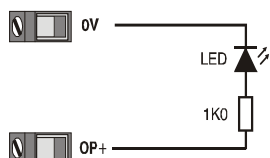

NOTE For details on testing outputs, see page 113

Digicom Outputs 1 - 8

The control panel has eight programmable outputs, which can be used for connecting to a stand-alone communicator (see page 77 for details). The table below shows the electrical characteristics for each output:

Terminal	Max Current	Operation
1	100mA	Switched 0V
2	100mA	Switched 0V
3	100mA	Switched 0V
4	100mA	Switched 0V
5	100mA	Switched 0V
6	100mA	Switched 0V
7	100mA	Switched 0V
8	100mA	Switched 0V
L/M	N/A	12V applied = Line Fault *
R/R	N/A	0V applied to reset
DC+	N/A	+12V Power (unfused)
DC-	N/A	0V Power

* Control Panel Line Fault Input (L/M)

In accordance with BSIA form 175, the line fault input on the control can detect a single or a dual line fault for use with the ATS Remote Test output type

Wiring a Stand Alone Communicator

The diagram below shows a typical wiring example:

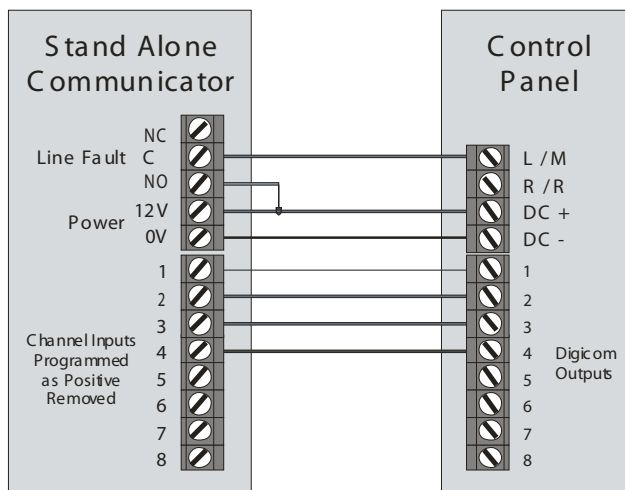

NOTE For details on testing the digicom outputs, see page 113

2-Wire Smoke Detector

Panel Output 1 can be used for connecting up to 10, 12V 2-Wire smoke detectors.

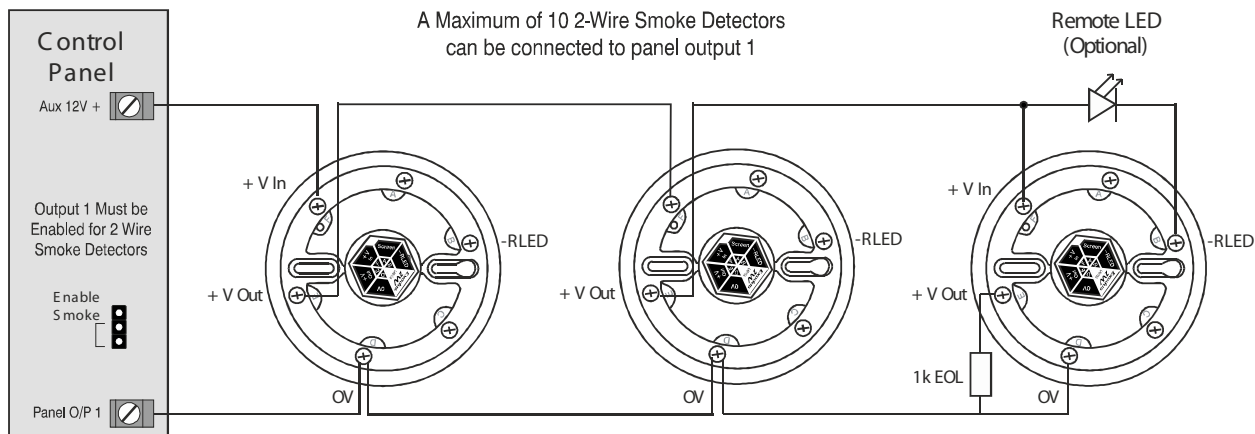

To enable 2-Wire smoke detection on panel output 1, a jumper link must be fitted across the bottom two pins of JP10. The Area Option '2-Wire Smoke' also needs to be enabled (see page 60).

NOTE 2-Wire smoke detectors can only be connected to panel output 1

Expander Auxiliary Input

This input can be used for monitoring a remote power supply that has a voltage free output for the following three conditions: AC Mains Fail, Battery Fail, 12V Fail and Tamper.

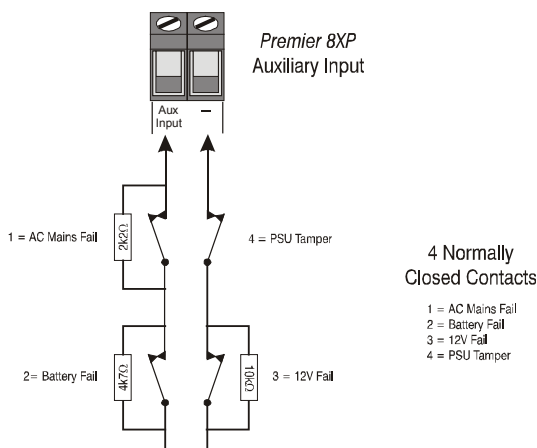

When the Auxiliary Input is programmed as 'PSU Monitor' the system will respond as follows:

Tamper	12V Fail	Battery Fail	A/C Fail	Resistance	Response
Closed	Closed	Closed	Closed	0R	No Faults
Closed	Closed	Closed	Open	2K2	AC Fail
Closed	Closed	Open	Closed	4K7	Battery Fail
Closed	Closed	Open	Open	6K9	Battery Fail + AC Fail
Closed	Open	Closed	Closed	10K	12V Fail
Closed	Open	Closed	Open	12K2	AC Fail + 12V Fail
Closed	Open	Open	Closed	14K7	Battery Fail + 12V Fail
Closed	Open	Open	Open	16K9	AC Fail + Battery Fail + 12V fail
Open	-	-	-	O/C	Lid Tamper

Plug-on Communicators

The *Com300* is a multi format 8-channel digital communicator/300-baud modem for use with a standard analogue telephone line.

The *Com2400* is a multi format 8-channel digital communicator/2400-baud modem for use with a standard analogue telephone line. In addition, this modem can also send Short Message Service (SMS) text messages to a mobile phone.

These Communicators can be used to report system events to an Alarm Receiving Centre using Fast Format, Contact ID or SIA Level II or to upload/download control panel information using the *Wintex UDL* software and a PC.

Plugging on the Communicator

Ensure that the board is the correct way up (see below). Locate the plug into the communicator socket on the control panel and line up the mounting holes with the pillars in the base. Once all the holes line up, press down gently until the pillars snap into the holes.

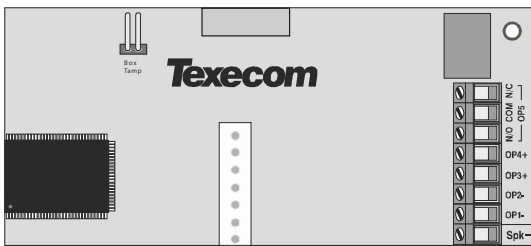
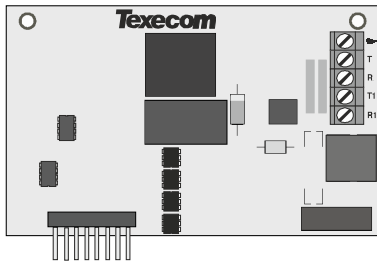

Top Right Hand Corner Premier 48/88/168/640 Control Panel
Right hand side of PCB Premier 24

48-W Connection

Carefully lift the control panel PCB and fix the COM unit into the space provided with the connection lead attached.

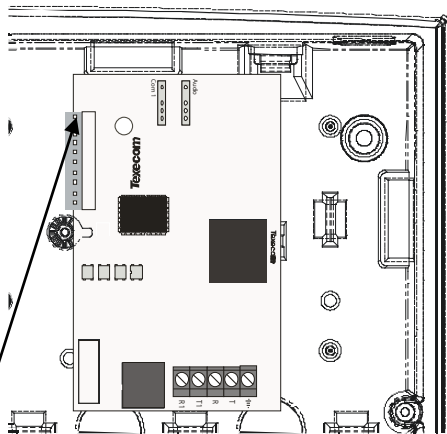

The red lead should be positioned on the uppermost pin of the COM unit.

The control panel end of the connector should be attached with the red lead on the left most pin of the digi modem connector.

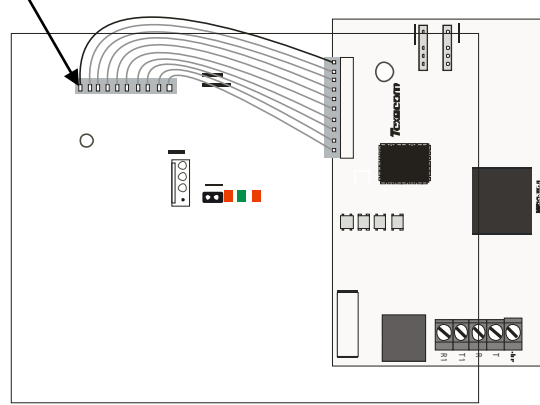

Standard Telephone Line Connections

A standard telephone line must be connected to the *Com300* or *Com2400* communicator as shown below:

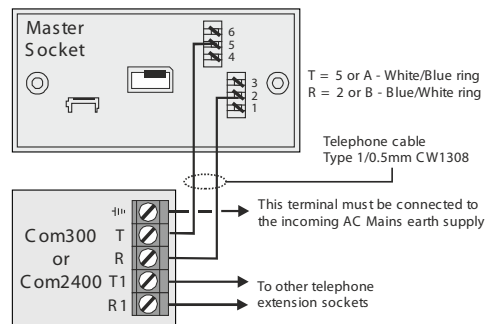

Com GSM

The **Premier Elite Com GSM** is a 2G module that can be connected to any **Premier Elite** control panel; however functionality differs depending on the type of Premier panel installed and the type of SIM card that is used. The tables below show which features are available and the type of SIM card required to enable the services.

Premier Elite 24/48/88/168 & 640	SIM Type		Panel Port Type	
	Dynamic IP	Fixed IP	GSM Module	Com IP
Report system events (alarms, arm, disarm etc.) via text messaging to mobile telephones	✓	✗	✓	✗
Remotely arm, disarm and obtain current status of the alarm system via text messaging	✓	✗	✓	✗
Upload/Download Via GSM	✓	✗	✓	✗
Alarm reporting to IP enabled receivers (Montex for example) GPRS	✓	✓	✗	✓
Upload/Download Via IP GPRS	✓	✓	✗	✓

NOTE A secondary form of communications should be used as back up where possible.

NOTE When using Alarm reporting over IP with Montex, SIA, Contact ID or, Fast Format may be used, however if using Tebase SIA is NOT supported. Some receivers may require a Fixed IP address, please check with your provider.

NOTE The Com port type must be programmed as one or the other, it is not possible to use both GSM and GPRS (IP Only) functionality at the same time.

SIM Card Types

SIM cards are split into two types:

- **Dynamic IP** SIM cards – the ‘everyday’ kind of SIM card used in mobile phones. GSM units that use this kind of SIM card can access any data on the internet but cannot be contacted from the internet. This type of SIM card should be used for SMS text messaging & Upload/Download via GSM. A data number will be required to use Upload/Download.
- **Fixed IP** SIM cards – specialist SIM cards that have a fixed, internet public IP address which means that in addition to being able to access any data on the internet they can be contacted from the internet. For **Premier Elite ComGSM** this means they can be used for **both** alarm reporting **and** upload/download via IP (GPRS) If a data number is also available, it is possible to use upload/download via the data number (GSM) instead of the IP address.

SIM cards **can** have two different phone numbers:

- Voice Number: used for voice calls and SMS
- Data Number: used for GSM data calls (Upload/Download)

Either of these facilities can be enabled/disabled by the operator.



Care should be taken when using Pay as you go SIM cards, make sure you have the ability to Top Up. Pay as You Go SIM cards generally DO NOT have data numbers, please check with your service provider.

SIM cards purchase

Texcom **DO NOT** supply SIM cards. These will need to be sourced locally, and care should be taken to source SIM cards in the country where the unit is to be used. This will help reduce costs and avoid excessive data charges. When using GSM as the communication method, Data services will need to be enabled for upload/download, this may or may not be the same Telephone number.

GPRS SIM card setup

In order to use **GPRS**, the **Premier Elite ComGSM** must be programmed with certain parameters which are dictated by the SIM card used. This is no different from mobile phones (often called the ‘GPRS Setup’) except that mobile phones are often supplied pre-configured.

The configuration consists of the following:

- APN (Access Point Name)
- Username
- Password

These parameters are entered into the **Premier Elite ComGSM** using a Texcom PC program called ‘APNProgrammer’ (on the Texcom CD supplied with the panel) with the **Premier Elite ComGSM** powered and connected to a PC via a **Texcom USBCom**.

To power the **Premier Elite ComGSM** whilst programming connect the supplied harness to the control panel com port, and the other end to the Engineers Keypad port on the **Premier Elite ComGSM**. The **Texcom USBCom** should be connected to the com port on the **Premier Elite ComGSM**.

Use APNProgrammer to upload the required information to the **Premier Elite ComGSM**.

The supplier of the SIM card should provide the information required.

Premier Elite ComGSM Layout

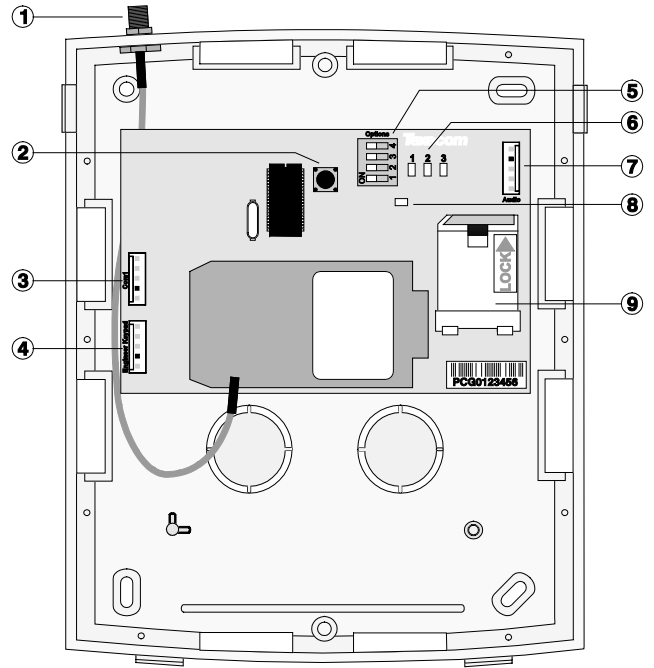

- ① Antenna connection
- ② Tamper switch
- ③ Com1 data connection to Premier control panel
- ④ Engineer keypad connector (only used to power the Premier Elite ComGSM when using APNProgrammer)
- ⑤ Option switches (see table below)
- ⑥ Status LED's (see table below)
- ⑦ Audio connector (for future use)
- ⑧ Heartbeat LED
- ⑨ SIM card socket

Option Switches

The option switches (⑤) function as follows:

Switch	Function	Off	On
1	Tamper Comms	GSM will not communicate if the unit is in tamper.	GSM will communicate regardless of the tamper.
2	GPRS server	Normal GSM operation	Accepts connections on port 10001 and allows reporting over GPRS
3	GSM/IP	IP mode (19200 baud) V1.65 and earlier only	GSM mode (9600 baud) V1.65 and earlier only
4	N/A	For future use – leave in OFF position	

Status LEDs

The three status LED's (⑥) indicate the following:

LED	Off	On	Flashing
1	GSM NOT Ready	GSM Ready	GSM Communicating
2	Panel NOT Ready	Panel Ready	Panel Communicating
3	No Signal (less than 40% Signal Strength or -88dBm)	Good (better than 66% Signal Strength or -77dBm or better)	Marginal (between 40%-66% or -88 ~ -77dBm)



The signal strength LED works for both GSM and GPRS modes; however the dBm reading is only seen on the keypad in GSM mode.

Aerial Siting

ALWAYS do a site survey to find an area of strong signal before installation. Installing a Com GSM with a weak signal is bad installation practice.

The aerial should be mounted vertically at the point of strongest signal. This is usually the highest point in the building (often the loft area).

Avoid installing the aerial directly under metal roofs or within metal skinned buildings because this will reduce the signal strength and may inhibit operation completely. If this is unavoidable, the strongest signal will be found away from the metal roof or close to large external windows or skylights.

Avoid installing the aerial close (2 metres) to cable runs, ducting, structural metalwork, metal pipes, water tanks and electronic equipment, e.g. photocopiers, fax machines etc. These can have similar effects to metal roofs.

Reliable operation is unlikely with a low signal strength. If the display shows that the signal strength is 40% (-88dBm) or lower, you should improve the signal strength. This may be achieved by repositioning the aerial. The GPRS aerial lead should not be cut, therefore repositioning the aerial may require that the **Com GSM** is also repositioned.

A mobile phone may be used to locate the point of strongest signal. The signal strength indicator is normally a bar or line at the side of the display on the mobile telephone.

The 'mobile phone' method cannot provide information on the availability, signal strength and interference status of all radio Base Stations in the surrounding area.

The signal strength reading is indicated on the Com GSM unit by use of LED's and can also be read from the keypad in the "Setup Modules" menu of UDL/Digi Options.

When you have identified the point of the strongest signal, make a note of this point and use it when installing the **Premier Elite Com GSM** aerial.

Installation

The **Premier Elite Com GSM** module should be installed as close to the control panel as possible, so that the harness lead supplied with the unit is able to plug onto the control panel communication port.



The connection harness cannot be extended.

Route the harness lead into the module housing using the top left cable entry and plug the connector onto COM1 (③)

1. Install the module in the required location using suitable fixings.
2. Route the other end of the harness lead into the control panel housing. DO NOT CONNECT at this point.
3. Connect the GSM antenna to the antenna connector on the module (①) and site the antenna as high as possible.
4. Unlock the SIM socket by sliding the locking tab downwards. Insert the SIM card into the holder with the chamfered corner to the top left. Push the holder back into position and lock the SIM by sliding the locking tab upwards.



The SIM card must be inserted before connecting the Premier Elite ComGSM module to the control panel, and must not be removed until after the power supply to the Premier Elite ComGSM module has been deactivated.

5. Set the option switches as required, see page 37.
6. Now connect the harness lead onto the control panel communication port (COM 1 or 2).

The module should now be powered and the heartbeat LED (⑧) should be flashing.



You should check and confirm that the signal strength is still the same as recorded during the site survey.

Panel Configuration

Text Messaging and Upload Download via GSM

GSM Mode (panel port programmed as GSM Module, Dynamic IP SIM card)

1. Enter "Engineers Programming" mode and select "UDL/Digi Options", then select "Com Port Setup". Ensure Com Port is programmed as "GSM Module".
2. Now select the "Digi Options" menu and make sure that "Digi Option 1" is programmed for "Digi is Enabled".
3. Now select "Program Digi" and ensure the following options are programmed for one of the ARC options:
 - a) Protocol: "SMS Messaging".
 - b) Primary No: The number of the recipient's mobile telephone.
 - c) Secondary No: Secondary mobile telephone number (if required).
 - d) Account No: Leave blank.
 - e) Dialling Attempts: Program as required.
 - f) Report Areas: Program as required.
 - g) Reports: Program as required.
 - h) Config.: Program as required.
 - i) Protocol Options : Program as required.
 - j) UDL Options : Change rings before answer to 1 if using GSM Upload/Download.
4. All three status LED's should now be on, if status LED 3 is off or flashing, this indicates a low GSM signal level. If the signal level is low, try moving the antenna to improve the reception.

Using the SMS Control Commands

Control commands can be sent to allow remote control and interrogation of the alarm system.

1. Select the send text message option on your mobile telephone.
2. Enter the telephone number of the *Premier Elite ComGSM* module.
3. Enter the text command, see SMS Control Commands.
4. Select send on your mobile telephone.

When using the SMS Control Commands shown in the tables below the following should be noted:

???? = User code, this must proceed all commands.

[areas] = Areas 1 to 8 or A to P. If the areas are not specified then all areas will be selected.

[s] = Send back status report

(zones) = List of zones, each zone must separated by a space e.g. 1 12 167 etc.

(outputs) = List of outputs, e.g. 1234 etc.

(message) = A maximum of 32 characters.

Premier 48/88/168/640 & Premier Elite 24/48/88/168/640 SMS Control Commands		
Operation	Command	Example
Arm System	???? arm [areas][s]	"5678 arm s" = arm all areas and report back status.
Part Arm System	???? parm (1/2/3)[s]	"5678 parm 1" = part arm 1 all areas (no status)
Disarm System	???? darm [areas][s]	"5678 darm abcs" = disarm areas abc and report back status.
Reset System	???? reset [areas]	"5678 reset" = reset all areas
Omit Zone(s)	???? omit (zones)	"5678 omit 1 5 12" = omit zones 1, 5 and 12
Unomit Zone(s)	???? uomit (zones)	"5678 uomit 12" = reinstate zone 12
Turn Outputs On	???? op on (outputs)[s]	"5678 op on 134" = turn PC outputs 1, 3 and 4 on.
Turn Outputs Off	???? op off (outputs)[s]	"5678 op off 4s" = turn PC output 4 off and report back status.
Pulse Outputs On	???? op on (outputs)[p]	"5678 op on p" = pulse PC output 2 on.
Pulse Outputs Off	???? op off (outputs)[p]	"5678 op off p" = pulse PC output 2 off.
Send Message	???? mess (message)	"5678 mess How Are You" = Displays How Are You on all keypads.
System Status	???? status	"5678 status" = Armed: (1 - 8 or A - P) Alarm: (1 - 8 or A - P) Output: (1 - 8) Mains: (OK or Fault) Battery: (OK or Fault) Phone Line: (OK or Fault)
Output Status	???? status O	"5678 status O" = Armed: (1 - 8 or A - P) Alarm: (A - P) Channels: (1 - 8) Digi: (1 - 8) Panel: (1 - 5) Mains: (OK or Fault) Battery: (OK or Fault) Phone Line: (OK or Fault)
GSM/Radio-Pad Status	???? status R	"5678 status R" = Serial: ##### (only if Radio-Pad fitted) NUA: ##### (only if Radio-Pad fitted) FSS: ### (only if Radio-Pad fitted) RSS: ### (only if Radio-Pad fitted) BER: ### (only if Radio-Pad fitted) CRC: ### (only if Radio-Pad fitted) GSM-Signal: ### GSM-BER: ###

- h) For Upload/Download via Wintex edit the Account/Panel Details and fill in the IP address you have been given and Port number.

All three status LED's should now be on, if status LED 3 is dim, this indicates a low GSM signal level. If the signal level is low, try moving the antenna to improve the reception.

What will be sent in the Text Message

The following information will be received in the text message:

— My Home —	— Name programmed into phone
3 Western Road	— Up to 16 characters of text (this is the Printer Header)
12:45.58 01/12	— Time and Date
Zone 003 Alarm	— Event Type
The Detector in	— Zone/User name text
the Lounge	— Area that caused the event
Area: A.....	

Alarm Reporting & Upload/Download via IP

IP Mode (panel port programmed as ComIP, fixed IP SIM card)

- Enter "Engineers Programming" mode and select "UDL/Digi Options", then select "Com Port Setup". Ensure Com Port is programmed as "ComIP". Leave the IP address, port & gateway blank.
- Now select the "Digi Options" menu and make sure that "Digi Option 1" is programmed for "Digi is Enabled".
- Now select "Program Digi" and ensure the following options are programmed for one of the ARC options:
 - Protocol: Program as required.
 - Account No: Program as required
 - Dialling Attempts: Program as required.
 - Report Areas: Program as required.
 - Reports: Program as required.
 - Config.: Program as required.
 - Protocol Options : Program as required.

AV Module

Before connecting the *AV Module*, isolate ALL power from the control panel (AC mains and battery), do not continue if there is still power present on the control panel.

To install the *AV Module* onto the control panel:

- Connect one end of the patch lead on to the Expansion Port of the *AV Module*
- Connect one other end of the patch lead on to the Expansion Port of the control panel

Programming the AV Module

- Program the Expansion Port for *AV Module* operation (see page 94 for details)
- Refer to the *AV Module* installation guide for full programming details.

ComIP Module

The *ComIP* module allows the *Premier Elite* control panels to be connected to either a Local Area Network (LAN) or Wide Area Network (WAN). The internet is considered as a WAN. Once the control panel is connected to a network the following features can be achieved:

- Upload/Download via *Wintex UDL*
- Signal alarms to an Alarm Receiving Centre
- High security polling by Alarm Receiving Centre

Typical LAN configuration

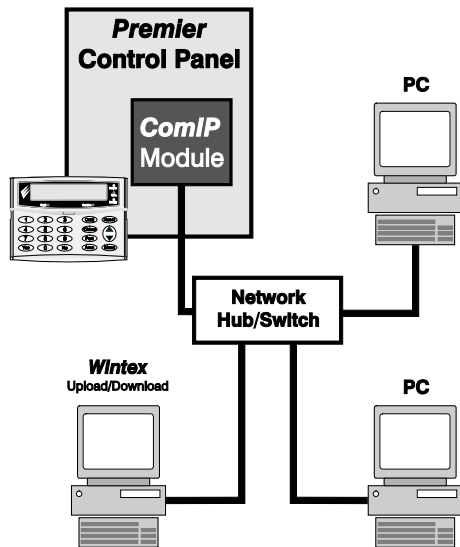

Typical WAN configuration

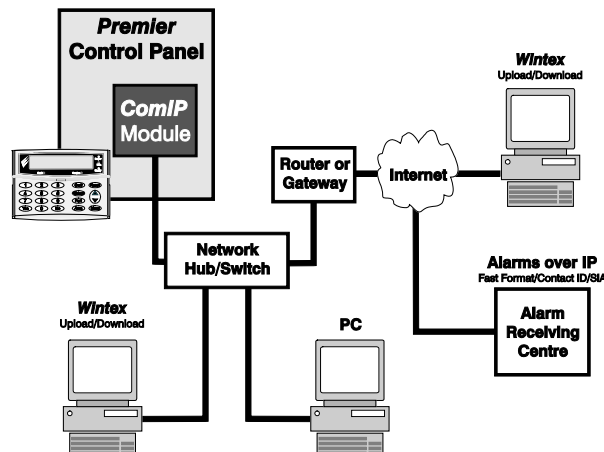

Installation

General

The installation of the *ComIP* module requires a basic understanding of networking and TCP/IP protocol. If you are not familiar with these concepts, you may require assistance from an IT professional before attempting to install the module.

The *ComIP* module is designed to be fitted inside the control panel and is powered via the harness connection. A suitable network cable should be fed into the control panel to allow connection the module.

PCB Layout

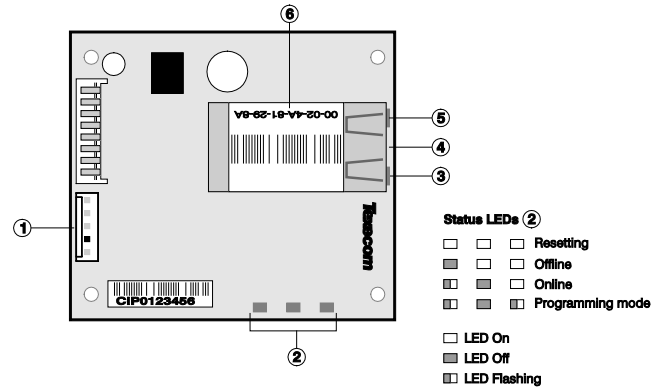

- ① 5-way harness connection to control panel
- ② *ComIP* Status LEDs
- ③ Network status LED (Left)
- ④ Network status LED (Right)
- ⑤ RJ45 network Connection
- ⑥ MAC address

Installation

1. Select "Engineers" mode on the control panel then remove the control panel lid.
2. Choose a suitable location for the module. Remember to allow enough space to plug in the network cable and connect the harness lead (supplied).
3. Fit the 4 self adhesive feet supplied to the four mounting holes. Remove the self adhesive backing paper and secure to the base of the control panel.
4. Connect the 5-way end of the harness to the 5-way connector on the module.
5. Connect the other end onto a control panel communication port.
6. Connect the network cable to the RJ45 connection on the module. The network status LED's indicate the following:

Left LED	Right LED	Meaning
Off	Off	No Link
Off	Solid Amber	100BASE-T Half Duplex Link
Off	Blinking Amber	100BASE-T Half Duplex; Activity
Off	Solid Green	100BASE-T Full Duplex Link
Off	Blinking Green	100BASE-T Full Duplex; Activity
Solid Amber	Off	10BASE-T Half Duplex Link
Blinking Amber	Off	10BASE-T Half Duplex; Activity
Solid Green	Off	10BASE-T Full Duplex Link
Blinking Green	Off	10BASE-T Full Duplex; Activity

Commissioning

The control panel must be programmed correctly in order for the module to function as expected. The following section covers the items that need to be configured on the control panel in order to make the *ComIP* module operate correctly.

The actual details on how to program the following items can be found in the relevant control panel installation manual.

ComIP Address

Each TCP/IP node on a network host has a unique IP address. This address provides the information needed to forward packets on the local network and across multiple networks if necessary.

IP addresses are specified as **x.x.x.x**, where each x is a number from 1 to 254; for example, 192.168.0.200. The *ComIP* must be assigned a unique IP address to use on a TCP/IP network. If the address is left blank or is programmed as 0.0.0.0 the *ComIP* module will try to automatically obtain an IP address from a DHCP server (if one is running on the network).

ComIP Port

The port number used to identify the channel for remote initiated connections. The default setting is 10001. The range for port settings is: 1-65535 except for the following reserved ports:

Port Numbers	Reserved for
1-1024	Reserved (well known ports)
9999	Telnet setup
14000-14009	Reserved
30718	Reserved
10000 - 10999	Recommended for raw socket connections

ComIP Gateway

The gateway address, or router, allows communication to other LAN/WAN segments. The gateway address should be the IP address of the router connected to the same LAN segment as the *ComIP*. The gateway address must be within the local network.

ComIP Netmask

A netmask defines the number of bits taken from the IP address that are assigned for the host section. The default mask is 255.255.255.0 (8 bits).

USB-Com

The *USB-Com* has two connectors. The USB connector is for connection to a USB port on a computer and the Molex connector plugs onto a Com port on the control panel.



PC-Com

The *PC-Com* has two connectors. The 9-way D-type connector is for connection to a serial port on a computer and the Molex connector plugs onto a Com port on the control panel.



PRINT-Com

The *PRINT-Com* has two connectors. The 25-way D-type connector connects to a Serial Printer and the Molex connector plugs onto Com 1 on the control panel.

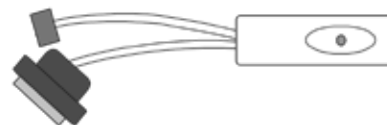

Connecting a Computer

The 24, 48, 88, 168 & 640 all support local uploading and downloading between the control panel and a PC running *Wintex UDL* software. Uploading and Downloading can be used to program and interrogate the control panel.

In order for the computer to work correctly, ensure that it is set to the following:

- UDL Password (see page 91 for details)

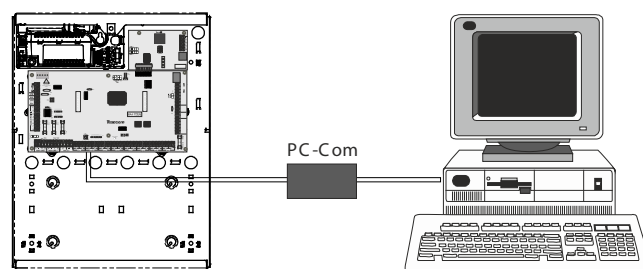

NOTE In order to upload and download to the control panel locally, a USB/PC-Com lead is required.

Connecting a Printer

The 24, 48, 88, 168 & 640 all support printer facilities. The printer is connected to the Com 1 connector located on the control panel and can be used to print the control panel event log.

In order for the printer to work correctly, ensure that it is set to the following:

- Baud Rate = 4800
- Parity = None
- Start Bits = 1
- Stop Bits = 2
- Data Bits = 8
- DTR = Normal
- Columns = 40 or 80 (see page 65)



NOTE In order to connect a printer to the control panel, a *PRINT-Com* lead is required.

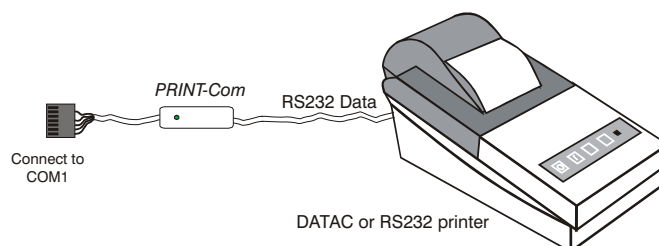

4. Commissioning and Troubleshooting

Commissioning

Once ALL connections have been made to the control panel and power is ready to be applied, you should read this section before continuing.

When applying power for the first time, the factory default settings must be loaded. The default settings ensure that the control panel software is reset and all programming information is loaded into memory. For a complete list of factory default settings, see separate Quick Reference Guide.

The factory default settings are loaded by applying power to the control panel whilst at the same time, holding down the **Factory Default** button.

To default the control panel, proceed as follows:

- Connect the black battery lead to the negative (-) terminal of the standby battery and the red battery lead to the positive (+) terminal of the standby battery
- Press and hold the **Factory Default** button
- Press the battery kick-start button to connect the battery and ensure that the green heartbeat light illuminates
- After the heartbeat light has illuminated, let go of the **Factory Default** button (the heartbeat light will continue to flash whilst the factory default settings are being loaded, this can take up to 30 seconds)
- If the system goes into alarm, **enter the default Engineer code** **1** **2_{abc}** **3_{def}** **4_{ghi}**, and the alarm tone will stop
- To access the Engineer Programming Menu, **enter the default Engineer code** **1** **2_{abc}** **3_{def}** **4_{ghi}**
- The "Confirm Devices" menu will appear check and make sure all installed Keypads and Expanders are showing, press Yes and Yes again to confirm.
- Program the system as described in section 5 (Programming the Control Panel)
- Perform a zone test as described on page 115. Remember that some powered detectors (e.g. PIR's and combined technology detectors) take up to 180 seconds to warm up and become operational
- Test the internal sounder, external sounder and strobe as described on page 115
- Replace the lid and secure with the lid screw supplied
- **Press** **0** **followed by YES** to leave the programming menu, the system will return to normal
- The display will be showing that there is a 'Mains Power Off' condition. Switch on the AC mains supply to the control panel
- The normal banner message (if programmed) will now be displayed

Installation is now complete and the system is ready for use.

Trouble-Shooting

Control Panel

No Power to unit (mains only)

- Check the mains block fuse and replace if blown
- Check for loose wires at the mains block, the transformer and the AC terminals on the PCB
- Check the mains block is connected correctly; live to live (brown), neutral to neutral (blue)

No Power to unit (battery only)

- Don't forget to press the battery kick-start button
- Check for loose wires at the BATT terminals on the PCB
- Check that the battery wires are connected correctly; red from BATT+ to the battery positive (+), black from BATT- to the battery negative (-)

Heartbeat LED is not flashing

- Remove ALL power (AC Mains and Battery) and then reapply power again

Network Data LED's are not flashing

- Remove ALL power (AC Mains and Battery) and remove ALL wires from the network terminals. Then re-apply power again before referring to the Network Diagnostics table on page 20

Keypads

Keypad does not operate

- Check that the keypad is wired correctly from the control panel (see page 20 for wiring details)
- Check the network fuses F3 and F5 and replace if blown*
- Use the network diagnostics (see page 20 for details)



NOTE *Only on 48/88/168

Keypad does not accept codes

- If the system has more than one keypad check that each keypad is addressed differently, see page 22 for details
- If the keypad is on a long cable run, check the voltage between the '+' and '-' terminals at the keypad and ensure that it measures no less than 10.0V
- Check that you are using the correct User codes. The default Engineer code is **1** **2_{abc}** **3_{def}** **4_{ghi}** and the default Master User code is **5_{kl}** **6_{mno}** **7_{pqr}** **8_{stv}**
- Check that the User code you are using is not 'Time Locked', if the User code is time locked then the access code will only be accepted when Control Timer 1 is off (see pages 68 and 110 for details)

Keypad zones do not operate

- Each keypad zone has to be mapped onto the system before it can be used (see page 73 for details)
- The zone is not programmed (see page 48 for details)

Keypad emergency keys do not operate

- Each keypad can be configured so that the emergency keys **PA**, **FIRE** and **MEDICAL** can be enabled or disabled. Check that the keypad has been programmed correctly (see page 73 for details)

Expander

Expander does not operate at all

- Check that the expander is wired correctly from the control panel (see page 20 for wiring details)
- Check the network fuses F3 and F5 and replace if blown*



NOTE *Only on 48/88/168

System does not recognise zones

- If the expander is on a long cable run, check the voltage between the + and – terminals at the expander and ensure that it measures no less than 10.0V

The speaker output does not work

- The expander can be configured so that Alarm, Entry, Exit, Chime tones etc. can be enabled or disabled. Check that the expander has been programmed correctly (see page 75 for details)
- The speaker volume on the expander is electronically adjustable. Check the volume is set to the desired level (see page 75 for details)

Zones

One or more zones show an alarm

- Check that the zone is wired correctly (see page 31 for wiring details)

Communicator

The Communicator will not dial

- By default the communicator is disabled, check that the communicator is enabled (see page 88 for details)
- Check that the telephone line has been correctly wired to the communicator (see page 36 for wiring details)
- Check that the telephone numbers are programmed correctly (see page 84 for details)
- Check that the account numbers are programmed correctly (see page 84 for details)
- Check that the dial attempts are not programmed as zero (see page 84 for details)
- Check that the reporting areas have been programmed correctly (see page 78 for details)
- Check that the reporting options have been programmed correctly (see page 78 for details)

Communicator dials but does not communicate

- Check that the telephone numbers are programmed correctly (see page 87 for details)
- Check that the correct protocol is programmed (see page 87 for details)

Operation

The system will not allow me to arm

- Check that there are no outstanding problems (see page 44 for details)
- Check that there are no outstanding alarms that require resetting
- Check that the User code has been programmed to allow arming (see page 110 for details)
- Check that the User code has been assigned to the correct areas (see page 107 for details)
- If a 'Local' User code is being used (see page 110 for details) ensure that the keypad being used is assigned to the correct area (see page 72 for details)

The system will not allow me to disarm

- Check that the User code has been programmed to allow disarming (see page 110 for details)
- Check that the User code has been assigned to the correct area(s) (see page 107 for details)
- If a 'Local' User code is being used (see page 110 for details) ensure that the keypad being used is assigned to the correct area (see page 72 for details)

Reset and Service Messages

When the system requires attention because of a potential problem, the display will show one of three service messages. These messages can also be accessed at any time, allowing the user to view installer information.



These messages would normally be programmed with the telephone numbers of the installer or the Alarm Receiving Centre (see page 69 for details).

To display the service messages, proceed as follows:

The display will normally show the time and date:

Tue 06 Mar 2005

Press **(Menu)** followed by **(1)** for the **Service** message:

Call Alarm Co
for Service

Press **(Menu)** followed by **(2_{abc})** for the **Reset** message:

Call Engineer to
Reset System

Press **(Menu)** followed by **(3_{def})** for the **Anti-code** message:

Call ARC
Reset System

Press **(Reset)** to exit from the message, the display will then return to normal.

When alarm information is being displayed, pressing the SCROLL key will slow down the display and also allow manual scrolling through the events.

Fault Warning Tones

When a fault condition occurs i.e. mains fail, line fault etc. the internal sounders will chime every 30 seconds for 3 minutes. The chiming will automatically stop when a valid User code is entered, when **(Reset)** is pressed or after 3 minutes (whichever occurs first). The fault indication will only be cleared from the display when the fault has been rectified i.e. power, telephone line has been restored.

Fault Messages

SYSTEM ALERTS!
Tue 06 Mar 2005

There are system faults waiting to be viewed, enter a valid user code to view the faults. After entering a code faults will be displayed for 30 seconds. If the fault is not reset within 30 seconds, this message will be displayed again.

Confirm Devices
Tue 06 Mar 2001

The number of devices connected to the networks has changed from the last time a 'Confirm Devices' was done.

You need a user
to enable access

Engineer access is programmed for Engineer code + User code (see page 64 for details).

You need a user
to unarm system

The Engineers code was entered when the system was fully armed (access to the programming menu can only be gained when the system is not fully armed).

Alarm Engineer
Working On Site

The alarm engineer has logged into the programming menu and is working on site (this message will clear when the engineer logs off or the system is armed).

Mains Power Off
Tue 06 Mar 2001

There has been an AC Mains failure.

ATS Path Fault
Tue 06 Mar 2001

There is a fault with the ATS (Alarm Transmission System).

No Path Available
Tue 06 Mar 2001

There are no ATS (Alarm Transmission System) paths available.

No Battery
Tue 06 Mar 2001

The Standby Battery has not been connected,

Battery Fault
Tue 06 Mar 2001

There is a fault with the control panel standby battery or it is not connected.

Area Failed Test
Tue 06 Mar 2001

Zones that have been placed on test have failed the test.

Panel Lid Tamper
Tue 06 Mar 2001

There is a fault with the control panel lid tamper.

Bell Tamper
Tue 06 Mar 2001

There is a fault with the bell tamper on the control panel.

Auxiliary Tamper
Tue 06 Mar 2001

There is a fault with the auxiliary tamper on the control panel.

Bell Fuse Blown
Tue 06 Mar 2001

The bell fuse on the control panel has blown.

Aux. Fuse Blown
Tue 06 Mar 2001

The Auxiliary fuse on the control panel has blown.

RKP X,X Tamper
Tue 06 Mar 2001

There is a fault with the lid tamper of Keypad X,X.

RKP X,X Lost
Tue 06 Mar 2001

Keypad X,X has been lost off of the system.

EXP X,X Tamper
Tue 06 Mar 2001

There is a fault with the lid tamper of Expander X,X

EXP X,X Lost
Tue 06 Mar 2001

Expander X,X has been lost off of the system.

EXP X,X Lo Volts
Tue 06 Mar 2001

The voltage at expander X,X is very low.

EXP Bell Tamp XX
Tue 06 Mar 2001

The expander's Auxiliary input (that is programmed as bell tamper) is in fault.

EXP Aux Tamp XX
Tue 06 Mar 2001

The expander's Auxiliary input (that is programmed as aux tamper) is in fault.

Service Required
Tue 06 Mar 2001

The service timer has expired indicating that the system requires a service (the system can normally still be used).

Sorry, Code not
allowed use TAG

The user code is locked out (normally during entry). The system must be disarmed using a Prox TAG.

Remote Keypad is
now LOCKED out

To many invalid code attempts have caused the keypad to lock out. The keypad will remain like this for 5 minutes.

* Area Secured *
Tue 06 Mar 2001

The keypad has been disabled to prevent unauthorised access. The display will automatically clear when it is re-enabled.

Time Arming >
A.....

Areas are being armed using one of the control timers (enter a valid User code to defer the arming for 30 minutes).

5. Programming the Control Panel

Introduction

All engineers should read this section carefully so as to familiarise themselves with the programming of the control panel.

To access the Programming menu, enter the factory default Engineer code **1** **2_{abc}** **3_{def}** **4_{ghi}**.

If a mistake is made whilst entering the Engineer code, simply re-enter the correct code.

WARNING

When an Engineers code is entered to gain access to the Programming menu, by default ALL zones and tampers are disabled.

A menu option can then be selected by pressing one of the keys shown or by using the **↕** key to search. Once selected, press **YES** to access that option.

To leave the selected menu option and return to the main programming menu, press **Reset**.

To exit from the Main Programming menu but still remain 'Logged' onto the system (zones and tampers still disabled), press **Reset** and the display will show 'Alarm Engineer Working On Site'.

To log the Engineer off the system, press **0** followed by **YES** and the system will revert to its normal condition.

The table below shows the menu options available:

Key	Menu Option	Page
1	Zone Setup	48
2_{abc}	Area Programming	54
3_{def}	Global Options	62
4_{ghi}	Keypad Setup	72
5_{jkl}	Expander Setup	74
6_{mno}	System Outputs	76
7_{pqrs}	UDL/Digi Options	83
8_{tuv}	Setup Users	107
9_{wxyz}	Engineer Utils	112
Part	Alter Part Arms	123
Menu	The Arming Menu	-
Menu	The User Menu	-
0	Log Off Engineer	47
Reset	Exit programming mode	47

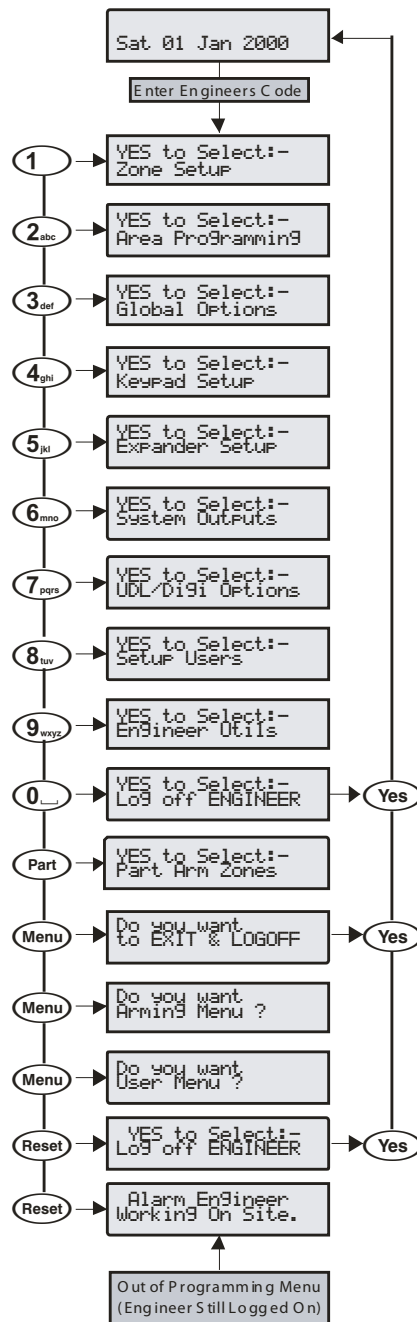

Programming Menu Guide

















Key	Main Menu	Key	Sub Menu
1	Zone Setup	Reset Yes Yes Yes Yes Yes Yes Yes Yes	Learn/Delete Ricochet Device Zone Types Zone Attributes 1 Zone Attributes 2 Zone Areas Zone Text Zone Chime Remote Test Zone Wiring Ricochet Device Mode
2	Area Programming	0 1 2 3 4 5 6 7	Timers Arming Modes Area Arm Suites Area Suite Text Suite Arm Modes Area Options Time Arm Areas Area Text
3	Global Options	0 1 2 3 4 5 6 7 8 9 Down Arrow	System Timers System Config. System Options Monitor Hardware Control Timers System Text Part Arm Text Holiday Dates Speaker Tones PC Output Text Custom O/P Text
4	Keypad Setup	Yes Yes Yes Yes Yes	Areas Zone Mapping Options Speaker Volume Sounder Options
5	Expander Setup	Yes Yes Yes Yes Yes	Areas Location Text Auxiliary Input Speaker Volume Sounder Options
6	System Outputs	0 1 2 3 4 5 6 6	Panel Outputs Digi Outputs Com? Channels RedCARE Pins Keypad Outputs Expander Outputs Custom Outputs X-10 Outputs
7	UDL/Digi Options	0 1 2 3 4 5 6 7 8	Reset Digi Test Com? Set Call Waiting Program Digi Digi Options UDL Options Area Accounts Radio/SMS Options Com Port Setup
8	Setup Users (not always available) (not always available) (not always available)	Omit Area Yes Yes Yes Yes Yes Yes Yes Yes Yes Omit	Learn/Delete SmartKey Assign SmartKey Routing User Code User Areas User Type User Options User Config. User Time Lock User Text Door Control Add TAG Add SmartKey™

Key	Main Menu	Key	Sub Menu
9	Engineer Utils	0 1 2 3 4 5 6 7 8 9 Down Arrow Down Arrow Down Arrow Down Arrow Down Arrow Down Arrow Down Arrow Down Arrow Down Arrow Down Arrow	View Event Log Do Bell Test Do Walk Test View Zone Status System Tests Confirm Devices View RKP Status View Exp. Status Set System Time Set System Date Location Text Print Log Data Soak Test Areas Change Eng. Code Adjust Volumes Default NVM Data View iD Data Configure Radio Ricochet Diag
Part	Part Arms	Omit Chime Part	Part Arm 1 Part Arm 2 Part Arm 3
Menu	Arming Menu	0 1 2 3 4 5 6 7 8 9 Down Arrow Down Arrow Down Arrow Down Arrow Down Arrow	Exit Menu Arm System Part Arm System Silent Arming Omit Zones Cancel Exit Disarm Areas Use Anti-code View Zone Status Omit 24Hr Zones Set Chime Areas View Act. Faults View Act. Counts Send SMS Text Defer Arming
Menu	User Menu	0 1 2 3 4 5 6 7 8 9 Down Arrow Down Arrow Down Arrow Down Arrow Down Arrow Down Arrow Down Arrow Down Arrow Down Arrow	Exit Menu View Event Log Change Code Edit Chime Zones System Tests Walk Test Enable Engineer Set System Time Set System Date Override Timers Alter Timers Setup Users Alter Part Arms Call Remote PC Alter Hol. Dates Adjust Volumes Print Event Log Edit Phone No's
Reset	Exit programming menu (engineer still logged on)		
0	Log Off Engineer		



Programming Text

Text is programmed in a similar way to mobile phones. Characters are selected by pressing the corresponding key the appropriate number of times (to select a character on the same key, press  to move the cursor along).

The table below shows the keys to use and the characters that are assigned to them:

Key	Character											
	_	0										
	.	,	?	!	1	@	"	-	&	%	/	+ = \$: ;
	A	B	C	2	a	b	c					
	D	E	F	3	d	e	f					
	G	H	I	4	g	h	i					
	J	K	L	5	j	k	l					
	M	N	O	6	m	n	o					
	P	Q	R	7	p	q	r	s				
	T	U	V	8	t	u	v					
	W	X	Y	9	w	x	y	z				
	Move Cursor											
	Backspace (delete)											
	Copy Text											
	Paste Text											
	Predictive Text											
	Upper/Lowercase, Predictive text and Clear Screen											

The control panel also features Predictive text. This can be used to make inserting words easier, i.e. when spelling the word PIR, instead of typing 7444777, all that you need to do is type 747 and the word is automatically selected.

 *This feature can be turned on and off as required by pressing the  key and can also be automatically selected every time text mode is entered (see page 64 for details).*

Copying and Pasting

When programming any items i.e. Zones, Timers, Options etc. pressing CHIME at any point will 'Copy' the information that has just been programmed into memory. To program another item using the information in memory, select the item and press PART to 'Paste' the information.

 *Copying and Pasting can only be performed whilst in the same option i.e. if a zone has just been programmed as Guard 1/Omit/Access/Areas-ABC, ALL of that information can be copied into memory so that when another zone is selected, the same information can then be quickly pasted to the other zone.*

The information held in memory after programming an item can only be pasted into an item of the same type and cannot be used once another option is selected i.e. Zone programming information cannot be pasted into Timers etc.





Log Off Engineer

Whenever the Engineer Programming menu is exited by pressing  twice, the display will look like this:





This message will remain on the display until the Engineer logs out of the Programming menu.

To log out of Engineer Programming menu, proceed as follows:

Enter an Engineer code    , the display should look like this:



Press  or , the display should look like this:

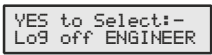



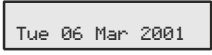

Press  to return to normal, the display will look something like this:



The Engineer is now logged out of the Programming menu.

 *The Engineer will be automatically logged out when the Engineer Logoff Delay Timer Expires (See Page 63)*

Resetting the Engineers Code (User 00)

If the Engineer code (User 00) has been lost or forgotten, it can normally be reset back to the factory default of    . However, this can only be done if the NVM has not been locked (see page 64 for details).

To Reset the Engineer code (User 00):



ENSURE THAT THE LID TAMPER IS CLOSED





Hold down the 'Factory Default' button for 6 seconds (with the control panel still powered), after 6 seconds, the sounders/keypads will beep to indicate that the Engineer code has been reset.

 *NO other codes/programming will be affected, it is just the User 00 Engineer code that will be reset.*

The Engineer (User 00) code can only be reset, if the NVM has not been locked (see page 64 for details).

Other Things to Know

The  key will always return to the previous menu level. This is often the only way to exit an option after programming it. Pressing  several times will always return to the top level menu and the logout screen.

The     and  keys often provide shortcuts or extended functions, refer to individual programming options for details.

5.1 Zone Setup

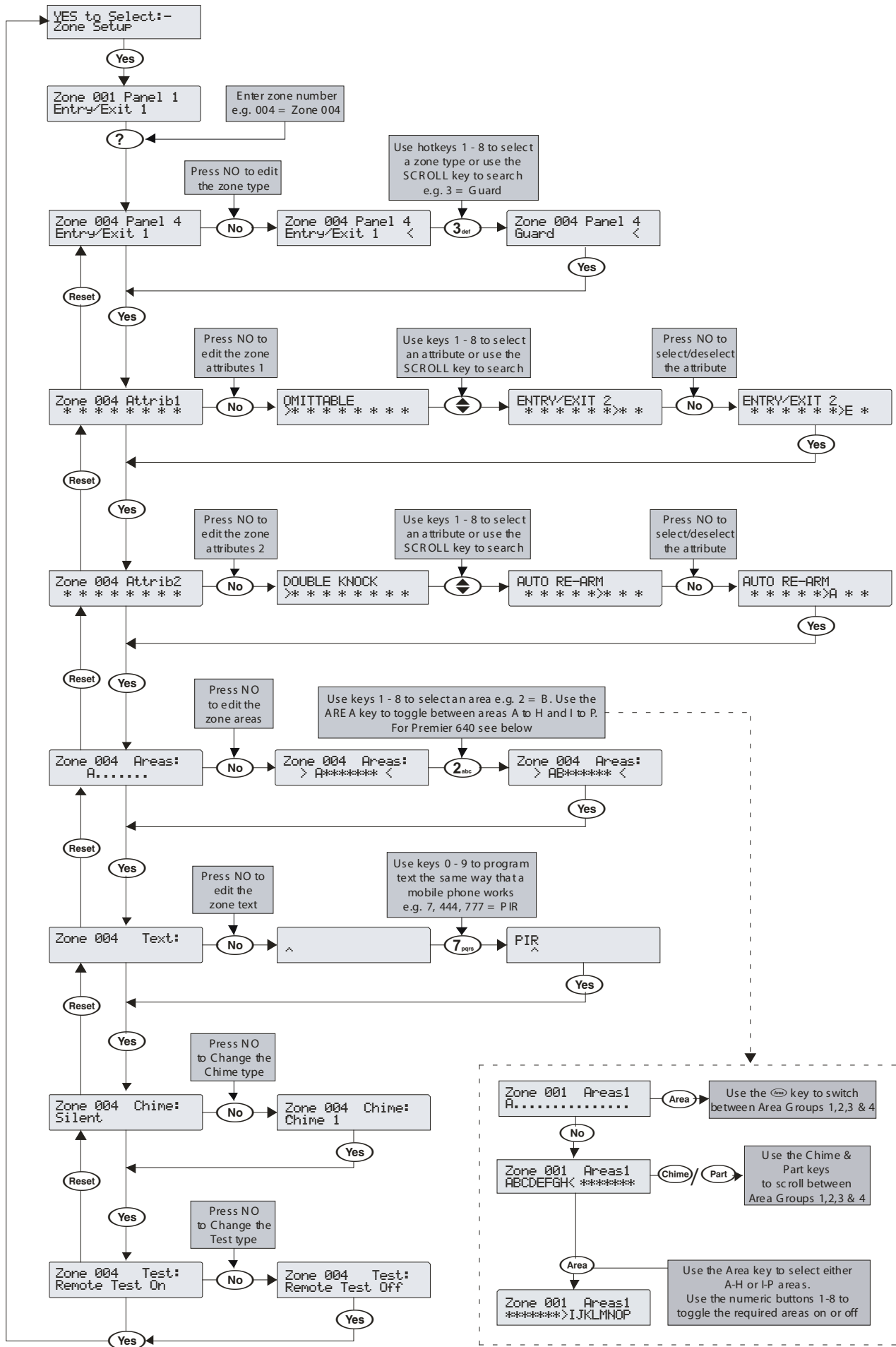

Ricochet Devices MT2

Option Switches

In this mode only option switch 3 should be on.

Introduction

The firmware upgrade now requires that **Ricochet™** devices are learned through the Zone Setup Menu, and **Premier Elite SmartKey™** are learned through the User Setup menu, the "Configure Radio" menu in Engineer's Utilities is now redundant and should not be used on MT2 systems.

Learning Devices

To learn a device to a Zone select the Zone from the Zone Setup Menu, Zones that are capable of having a **Ricochet™** device learnt to them will be displayed as follows:-

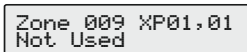

Fig 1

Fig 1 indicates the pre-assigned zone number, the expander being used and the device slot on the expander.

Once a device has been learnt the display will be as Fig 2:-

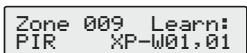

Fig 2

If you are unsure if a zone already has a device learned to it, you can go to the menu as in Fig 1, press **Reset** and then **No** if a device is already learnt the display will look like Fig 2, if not then it will look like Fig 3

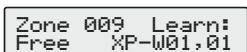
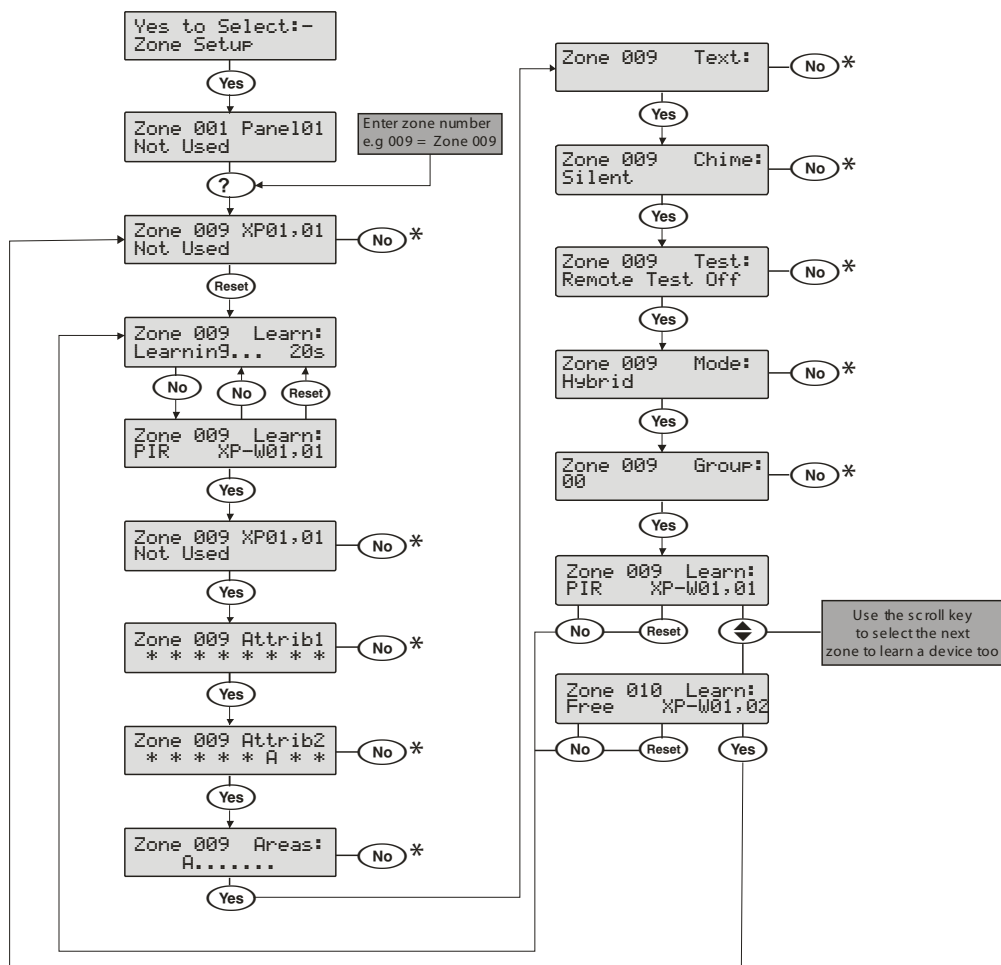

Fig 3

Deleting Devices

To delete devices from the expander is the same as learning them; choose the zone you wish to delete, and follow the procedure to learn the device, when the screen shows "Learning" press **Reset**.

Learning Devices



* Please refer to previous page for details on programming these options

Zone Types

Each zone must be programmed before it is recognised by the system.

Zone numbers are entered as a three digit number i.e. Zone 1 would be entered as 001. Each zone consists of a zone type, attributes, areas and zone text.

When programming zones, first select a zone type then select any required attributes, assign the zone to an area and then program any required zone text.

Zone Type + Zone Attributes + Zone Areas + Zone Text = Zone Programmed.

The following zone types are available:

0 - Not used

A zone that is not monitored by the system, unused zones should be programmed as 'Not Used' or linked out.

1 - Entry/Exit 1

Normally used for the main entry/exit door i.e. Front Door. The zone can be activated during the exit mode without causing a 'Fault'. Once the system/area is armed, activation of the zone will start the 'Entry 1 Delay' timer for the selected area.

2 - Entry/Exit 2

Normally used for another entry/exit door that requires a different entry delay i.e. Back Door, Garage Door etc. The zone can be activated during the exit mode without causing a 'Fault'. Once the system/area is armed, activation of the zone will start the 'Entry 2 Delay' timer for the selected area.



NOTE If any Entry/Exit zone remains active at the end of the entry time, it will automatically be omitted until the system has been unset and re-set.

If an Entry/Exit zone type is locked out, 'Guard Access' zones in the same area as the omitted Entry/Exit zone will automatically become 'Entry/Exit 1' zones to allow access into the premises without causing an alarm.

If an 'Entry/Exit 1 or 2' zone type is assigned the 'Entry/Exit 2' attribute (see page 51), when a zone with the 'Guard' attribute activates and causes an alarm (when the area is fully armed), the zone will become a 'Guard' zone for the duration of the 'Abort' timer.

3 - Guard

Normally used for detection devices such as PIR's, Door Contacts etc. This zone type will cause an Intruder alarm if it is activated when the system/area is armed. This zone type will also activate any output programmed as 'Guard Alarm'.

4 - Guard Access

Normally used for detection devices along the entry/exit route. This zone type will allow the user to walk past the detector without causing a 'Fault' during the exit mode or an Intruder alarm during the entry mode, however, the zone will cause an immediate Intruder alarm if activated at any other time. This zone type will also start the entry mode when the system/area is part armed and activate any output programmed as 'Guard Access Alarm'.

5 - 24Hr Audible

This zone type will cause an internal alarm if it is activated when the system/area is disarmed and will cause an Intruder alarm when the system/area is armed. The panel will also report a '24-Hour' alarm to the Alarm Receiving Centre when using 'Contact ID' reporting.

6 - 24Hr Silent

This zone type will cause a silent alarm if it is activated when the system/area is disarmed and will cause an Intruder alarm when the system/area is armed. The panel will also report a '24-Hour' Alarm to the Alarm Receiving Centre when using 'Contact ID' reporting.

7 - PA Audible

Normally used for monitoring Panic or hold-up alarms. This zone type will cause a Panic alarm if it is activated when the system/area is armed or disarmed.

8 - PA Silent

Normally used for monitoring Panic or hold-up alarms. This zone type will cause a silent Panic alarm if it is activated when the system/area is armed or disarmed.

9 - Fire

Normally used for monitoring smoke detectors. This zone type will cause a Fire alarm with distinctive fire tone if it is activated when the system/area is armed or disarmed. In addition, the bell output will pulse.

10 - Medical

This zone type will cause a Silent alarm if it is activated when the system/area is armed or disarmed. The panel will also report a Medical alarm to the Alarm Receiving Centre when using 'Contact ID' reporting.

11 - 24Hr Gas

This zone type will cause an Audible alarm if it is activated when the system/area is armed or disarmed. The panel will also report a 24-Hour Gas alarm to the Alarm Receiving Centre when using 'Contact ID' reporting.

12 - Auxiliary

This zone type will cause a Silent alarm if it is activated when the system/area is armed or disarmed. The panel will also report an Auxiliary alarm to the Alarm Receiving Centre when using 'Contact ID' reporting.

13 - Tamper

This zone type will cause an Internal alarm if it is activated when the system/area is disarmed and will cause an Intruder alarm when the system/area is armed.

14 - Exit Terminator

This zone type is used to finalise the arming procedure when arming the system/area (see page 55 for details).

15 - Moment Key

This zone type can be used to arm and disarm one or more areas. When the zone is activated and then secured the areas assigned to the zone will arm. When the zone is subsequently activated and then secured the system will disarm the areas assigned to the zone. Tamper faults will not arm or disarm anything, but will cause a Tamper alarm.

16 - Latch Key

This zone type can be used to arm and disarm one or more areas. When the zone is activated, the areas assigned to the zone will arm. When the zone is secured, areas assigned to the zone will disarm. Tamper faults will not arm or disarm anything, but will cause a Tamper alarm.

17 - Security

This zone type can be used to Lockout keypads. When the zone is activated, keypads assigned to the same area will not accept any key presses. When the zone is secured, all keypads respond as normal.

18 - Omit Key

This zone type will isolate any zone assigned to the same area as long as it has the 'Omit' attribute.

19 - Custom

This zone type can be programmed to operate as required using its own set of attributes (see page 52 for details).

20 - Conf PA audible

This zone type is for use with multi action PA buttons, or where a confirmed PA is required, and will activate local sounders.

21 - Conf PA silent

This zone type is for use with multi action PA buttons, or where a confirmed PA is required, and will not activate local sounders.

Zone Attributes 1

Attributes can be assigned to a zone to alter its operation i.e. a Guard zone with the 'Access' attribute will allow the user to walk past the detector without causing a 'Fault' during the exit mode or an Intruder alarm during the entry mode.

Select attributes by pressing keys 1 to 8 (a letter on the display means the attribute is selected, a Dot on the display means the attribute is not selected).

The following attributes are available:

O - OMITTABLE

Zones with this attribute can be manually omitted.

Zones without this attribute cannot be manually omitted.

F - FORCE OMIT

Zones with this attribute will be omitted if they are not secure at the end of the exit mode.

Zones without this attribute will cause an 'Arm Fail' if they are not secure at the end of the exit mode.

1 - PART 1 OMIT

Zones with this attribute will be omitted when 'Part Arm 1' is selected.

Zones without this attribute will respond as normal.

2 - PART 2 OMIT

Zones with this attribute will be omitted when 'Part Arm 2' is selected.

Zones without this attribute will respond as normal.

3 - PART 3 OMIT

Zones with this attribute will be omitted when 'Part Arm 3' is selected.

Zones without this attribute will respond as normal.

A - ACCESS

Zones with this attribute will not cause a 'Fault' during the exit mode or an Intruder alarm during the entry mode. However, if the zone is activated at any other time an Intruder alarm will occur.

Zones without this attribute will respond as normal.

E - ENTRY/EXIT 2

Zones with this attribute will start the 'Entry Delay 2' timer for the selected area when the area is part armed.



NOTE

'Entry/Exit 1 or 2' zones with this attribute will become a 'Guard' zone for the duration of the 'Abort' timer if a zone with the 'Guard' attribute activates and cause an alarm (when the area is fully armed).

Zones without this attribute will respond as normal.

G - GUARD

Zones with this attribute will cause an Intruder alarm when the area is part armed (this would normally be used on 'Entry/Exit 1 or 2' zone types).



NOTE

When the area is fully armed, activation of a zone with this attribute will cause any 'Entry/Exit 1 or 2' zone with the Entry/Exit 2 attribute to become a 'Guard' zone for the duration of the 'Forced Entry' timer.

Zones without this attribute will respond as normal.

Zone Attributes 2

Select attributes by pressing keys 1 to 8 (a letter on the display means the attribute is selected, a Dot on the display means the attribute is not selected).

The following attributes are available:

D - DOUBLE KNOCK

Zones with this attribute will only cause an alarm if it is activated twice within the 'Double Knock' time window or for the duration of the time window.

Zones without this attribute will respond as normal.

B - BEAM PAIR

Zones with this attribute will only cause an alarm if two zones (assigned to the same area) with this attribute are activated within the 'Beam Pair' time window.

Zones without this attribute will respond as normal.

T - ON TEST

Zones with this attribute will be put on soak test for the duration of the soak test timer (see page 62), when the area soak test option is selected (see page 120)

Zones without this attribute will respond as normal.

A - ACTIVITY

Zones with this attribute will cause an activity fault to be displayed at the time of arming if they have not been activated during the 'Activity Delay' period. If 'Config. option 14' (see page 64 for details) has been set to 'Activity Fault Bar' the system/area cannot be armed until the zone has been activated (forced walk test).

Zones without this attribute will respond as normal.

R - RESET

Zones with this attribute will not be monitored during the 'Detector Reset' period i.e. when the exit mode is started and power is removed from certain detectors (to reset them) the 'Fault' on the zone is ignored.

Zones without this attribute will be monitored as normal.

A - AUTO RE-ARM

Zones with this attribute will only re-arm at the end of the bell duration providing that the 'Re-arm' limit has not been reached (see page 67 for details). Once this limit has been reached, the zone will lock out and not cause any further Intruder alarms.

Zones without this attribute will always re-arm at the end of the bell duration.

Q - QUICK RESPONSE

The response time of the zones with this attribute is governed by the 'Zone Loop' response Timer (see page 62 for details).

The response time of a zone without this attribute is fixed at 250mS.

E - ENGINEER ALARM

Zones with this attribute will cause an Intruder alarm when activated if the engineer arms the system/area.

Zones without this attribute will not cause an Intruder alarm when activated if the engineer arms the system/area.

Attributes for Moment or Latch Keys

Select attributes by pressing keys 1 to 8 (a letter on the display means the attribute is selected, a Dot on the display means the attribute is not selected).

The following attributes are only available for 'Moment Key' or 'Latch Key' zone types.

I - INSTANT ARM

When using a key switch, the area will arm instantly.

P - PART ARMING

When using a key switch, the area will 'Part' arm.

F - FULL ARM DISABLE

When using a key switch to 'Full' arm an area, the key switch is disabled once the area is armed.

D - DISARM ONLY

The key switch cannot be used for 'Arming' (it can only be used for 'Disarming').

F - SILENT ARMING

When arming using a key switch, the selected areas will arm silently.

T - TIME ARM DISABLE

Activation of the key switch will override the 'Time Arming' feature on the control panel and prevent it from operating until the zone is reinstated.

K - KEY TUBE

A key switch zone type with this attribute will log when the zone is activated and also when the zone is restored.

Attributes for Custom Zones

Select attributes by pressing keys 1 to 8 (a letter on the display means the attribute is selected, a Dot on the display means the attribute is not selected).

The following attributes are only available for 'Custom' zone types.

I - INTERNAL

Activation of this zone (when armed) will cause the internal sounders to activate.

B - BELL/STROBE

Activation of this zone (when armed) will cause the external sounder/strobe to activate.

M - MONITOR 24Hr

The zone is armed at all times.

C - ENABLE COMS

Activation of this zone (when armed) will cause the area 'Alarm' output to activate.

NOTE Any Custom zone with this attribute will activate both the internal and external sounders even if they are not enabled above.

W - WARNING REQ.

If the zone remains Active for the duration of the 'Warning Delay' timer (see page 63), a warning tone will occur every 30 seconds for 3 minutes (or until a code is entered or **Reset** is pressed).

NOTE If MONITOR 24Hr is enabled, an internal alarm will occur after the Warning Delay.

Zone Areas 24/48/88/168

The 24 can be divided into two separate areas of protection, the 48 can be divided into four separate areas of protection, the 88 can be divided into eight separate areas of protection, and the 168 can be divided into sixteen separate areas of protection. This allows different parts of a building to be armed and disarmed independently from each other. By default all zones are assigned to area A, but if required, a zone can be assigned to any number of areas.

NOTE If a zone is assigned to more than one area, it will only be recognised by the system when all areas it is assigned to, are armed.

Zone Areas 640

The 640 can be divided into sixty four separate areas of protection. This allows different parts of a building to be armed and disarmed independently from each other. By default all zones are assigned to area A, but if required, a zone can be assigned to any number of areas.

NOTE If a zone is assigned to more than one area, it will only be recognised by the system when all areas it is assigned to, are armed.

Programming of Zone Areas for the 640 has additional requirements.

Areas on the 640 are divided into 4 sets of 16 areas identified by the table below.

Area Groups	Area's
1	A,B,C,D,E,F,G,H,I,J,K,L,M,N,O,P,
2	A,B,C,D,E,F,G,H,I,J,K,L,M,N,O,P,
3	A,B,C,D,E,F,G,H,I,J,K,L,M,N,O,P,
4	A,B,C,D,E,F,G,H,I,J,K,L,M,N,O,P,

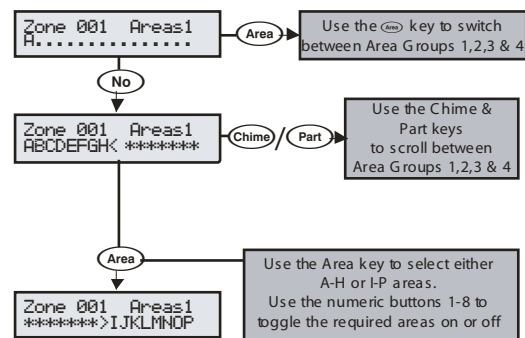

Zone Text

Each zone can have up to 32 characters of descriptive text assigned to it. Text is programmed in a similar way to mobile phones. Select characters by pressing the corresponding key the appropriate number of times (to select a character on the same key, press **↕** to move the cursor along).

For a more information, see page 47.

The control panel also features Predictive text. This can be used to make inserting words easier, i.e. when spelling the word PIR, instead of typing 7444777, all that you need to do is type 747 and the word is automatically selected.

NOTE This feature can be turned off if required by pressing the **Omit** key and can also be automatically selected every time text mode is entered.

Zone Chime

Each zone can be programmed to chime the internal sounders using one of the available chime tones when activated.

Remote Test Enable

Any zone with this attribute will be tested when the remote test function is initiated from **Wintex**. Any detector on a zone with the remote test attribute will be expected to go into alarm during the remote test, if it does not go into alarm, the detector will be reported as faulty.



NOTE This facility is only to be used in conjunction with system output type 47 '**Detector Test**' see page 78.

Zone Wiring

Zone wiring connections are shown on page 31 the following programming options are available.

0 - Normally Closed

For use on normally closed devices without tamper protection. Normally used for keyswitches. See **Normally Closed** wiring diagram on page 31

1 - Normally Open

For use on normally closed devices without tamper protection. Normally used for keyswitches. See **Normally Open** wiring diagram on page 31

2 - Double Pole/EOL

Default zone wiring configuration.

3 - Triple EOL

Standard Texecom TEOL, use this wiring type for all Texecom anti masking detectors.

4 - 1K/1K/(3K)

Alternative TEOL configuration with 1K alarm resistor, 3K fault resistor and 1K EOL resistor

5 - 4K7/6k8/(12K)

Alternative TEOL configuration with 6K8 alarm resistor, 12K fault resistor and 4K7 EOL resistor.

6 - 2K2/4K7/(6k8)

Alternative TEOL configuration with 4K7 alarm resistor, 6K8 fault resistor and 2K2 EOL resistor

7 - 4K7/4k7

Alternative EOL configuration with 4K7 alarm resistor and 4K7 EOL resistor.

8 - WD Monitor

Specialised wiring configuration for monitoring warning devices with fault reporting capability. Only use this wiring type on zones types programmed as **Auxiliary**. Normally wired as a **Normally Closed** circuit.

Ricochet Device Mode

Ricochet Device Mode determines how wireless devices will operate on the system. This option only appears in the menu after a device has been learned to the zone, and replaces the wiring type options.

- Always Awake
 - This mode should only be used on devices which are required to signal at all times and is the default setting for the **Impaq Contact-W** and **Impaq Plus-W**.
- Hybrid
 - Hybrid mode is used to control the reporting functions for devices. When in the mode devices are asleep when the system is set, and are woken up by the control panel at the point of arming. When the system is disarmed the devices will be put back to sleep. This mode of operation is the default mode for **XT-W**, **QD-W** & **DT-W**.
- Auto
 - When in Auto Mode, devices poll at 15 minute intervals. Following activation, devices will not transmit the same activation again for a period of 3 minutes.

- Exp O/P 1-2*
- Exp O/P 3-4*
- Exp O/P 5-6*
- Exp O/P 7-8*
- Exp O/P 1-3*
- Exp O/P 4-6*

* For Future Use

Zone Groups

Zone groups allow multiple zones to be assigned to a Zone Group Output. Once assigned triggering any of the zones assigned to the group will trigger the output.

The default option for each Zone is 0 and means the Zone is not assigned to any group.

Please see page 82 for the programming options for the Zone Group Output Type.

Panel	Output Groups
24	2
48	4
88	8
168	16
640	64

DD 243

To comply with DD 243, during the normal entry delay, the control panel must prevent a Confirmed Intruder Alarm from being reported to the Alarm Receiving Centre.

WARNING

Owing to the ability to disable ALL of the confirmation facilities, the customer should be advised in writing by the alarm company that ALL means of alarm confirmation are disabled when the initial entry door is opened. The alarm company should then obtain written acceptance from the customer of the disabling of the means of alarm confirmation.

5.2 Area Programming

Timers

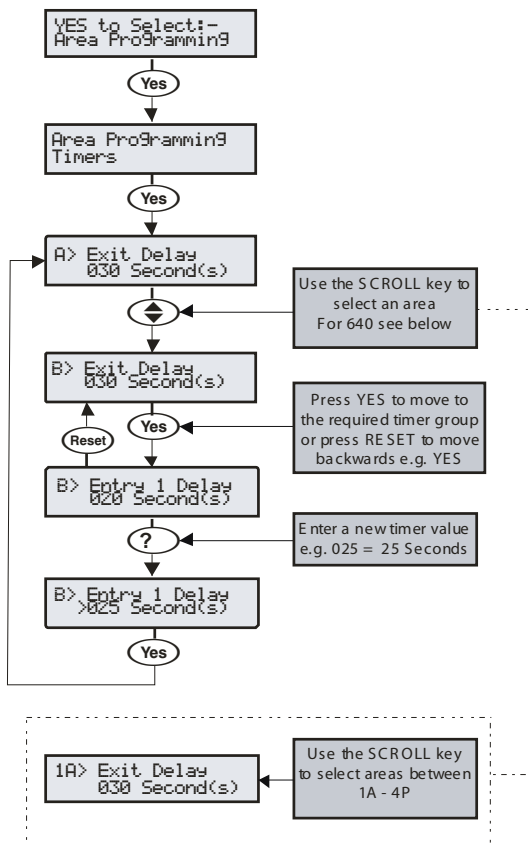

These groups of 'Area' timers control timing and delay functions for areas A - B (24) A - D (48), A - H (88) and A - P (168) & groups 1-4 Area A-P (640) Each timer can be programmed for any value between 000 and 999.



The area bell timers in options 5, 6 and 8 below are only active when system config option 5 is switched to 'Area Bell Time'.

Timers listed are for Areas A to B (A to D) (A to H) (A to P) (1,2,3,4, A-P) depending on the panel being used.

1 - Exit Delay

When the area exit mode is programmed as 'Timed' this timer controls the delay between the user initiating the exit mode for the selected area and the area actually.

2 - Entry 1 Delay

If the area is armed and an 'Entry/Exit 1' zone is activated, this timer will start and the entry tone will be heard. If the area is not disarmed before this timer expires, the '2nd Entry Delay' timer will start.

3 - Entry 2 Delay

If the area is armed and an 'Entry/Exit 2' zone is activated, this timer will start and the entry tone will be heard. If the area is not disarmed before this timer expires, the '2nd Entry Delay' timer will start.

4 - 2nd Entry Delay

When the area 'Entry Delay 1 or 2' timer expires, this timer will start and an Internal alarm will occur. If the area is still not disarmed before this timer expires, an Intruder alarm will then occur.

5 - Bell Delay

This timer controls the delay between an Intruder alarm occurring in the selected area and the 'Bell/Strobe' output activating.

6 - Bell Duration

This timer controls the duration of the 'Bell' output after an Intruder alarm has occurred in the selected area and any programmed 'Bell Delay' has expired.

7 - Coms Delay.

This timer controls the delay between an Intruder alarm occurring in the selected area and the communicator reporting to the Alarm Receiving Centre.

8 - Part Bell Dly. for Areas A to D (A to H) (A to P)

When the selected area is 'Part Armed' this timer controls the delay between an Intruder alarm occurring in the selected area and the 'Bell/Strobe' output activating, the internal sounders will also sound during this time as a warning.

9 - Confirm PA Timer, for Areas A to B (A to D) (A to H) (A to P) (1A to 4P)

When a Panic Alarm is raised in any area a confirm PA timer is started for that specific area. If a second PA alarm (including tamper from any other device in the same area) is raised while the PA timer is active a Confirmed PA Alarm is raised.

Arming Modes

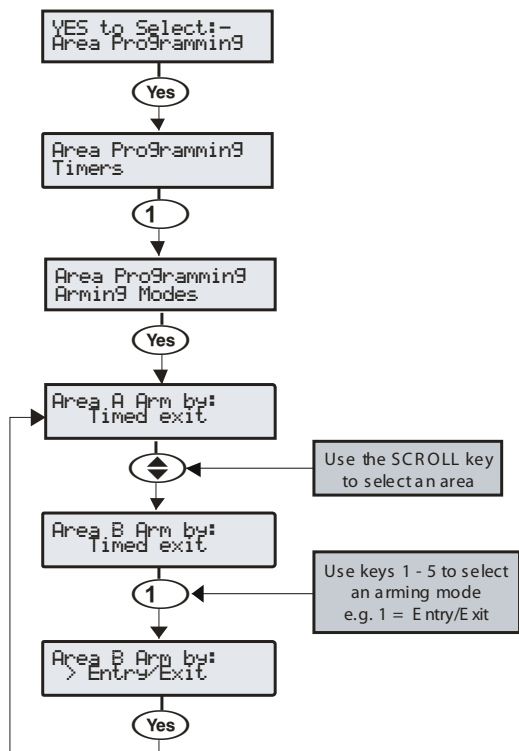

The way that an area arms can be configured for any of the following options:

1 - Entry/Exit

The area will arm after the 'Entry/Exit' door has been closed and the 'Exit Settle' timer has expired.

2 - Exit Term.

The area will arm after the 'Entry/Exit' door has been closed, the 'Exit Terminator' button has been pressed and the 'Exit Settle' timer has expired.

3 - Timed Exit

The area will arm after the programmed 'Exit Time' has expired.

NOTE If an 'Exit Terminator' zone is activated at any point during the exit mode, any remaining exit time is cancelled and the area will arm immediately.

4 - Instant

The area will arm instantly.

5 - Deferred

The area will arm after the programmed 'Exit Time' has expired. However, if any zones not on the exit route are activated during the exit mode, the 'Exit Time' is restarted.

Area Arm Suites 24/48/88/168

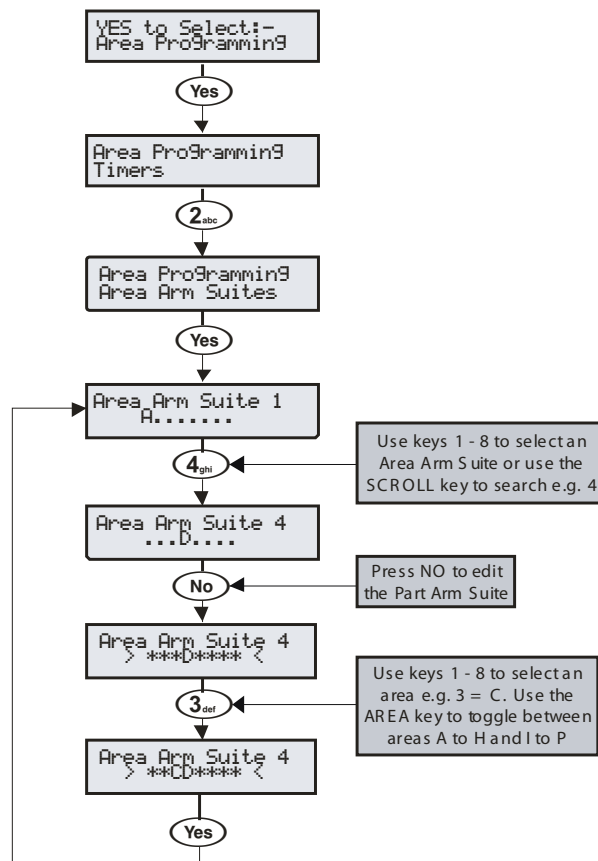

The 24 has 2 Area Arm Suites the 48 has 4 Area Arm Suites the 88 has 8 Area Arm Suites the 168 has 16 Area Arm Suites. Any number of areas can be assigned to each suite. Areas assigned to an Area Arm Suite will be armed when the suite is selected, making it easier for the user to select multiple areas if required.

Example

Area Arm Suites could be useful in a domestic situation where the user wants to arm areas A and B at night but does not want to select each area individually.

- Areas 'A and B' would be assigned to 'Area Arm Suite 1'
- When the user wants to arm the system at night, 'Area Arm Suite 1' would be selected
- Areas A and B are automatically selected for arming

NOTE Descriptive text may also be assigned to the Area Arm Suite (see page 56 for details).

Area Arm Suite Controller

The suites can be assigned to keypads so that different combinations of areas can be armed or disarmed depending on which keypad is used (see page 73 for details) and operates as follows:

- Keypad 1 = Area Arm Suite 1, Keypad 2 = Area Arm Suite 2, Keypad 3 = Area Arm Suite 3 etc.
- When a User code is entered at a keypad, one of the 'Area Arm Suites' is selected (depending on which keypad was used) and the areas contained within that suite arm using the arming mode for that suite, the keypad sounder will also follow the areas defined by the suite.

Area Arm Suites 640

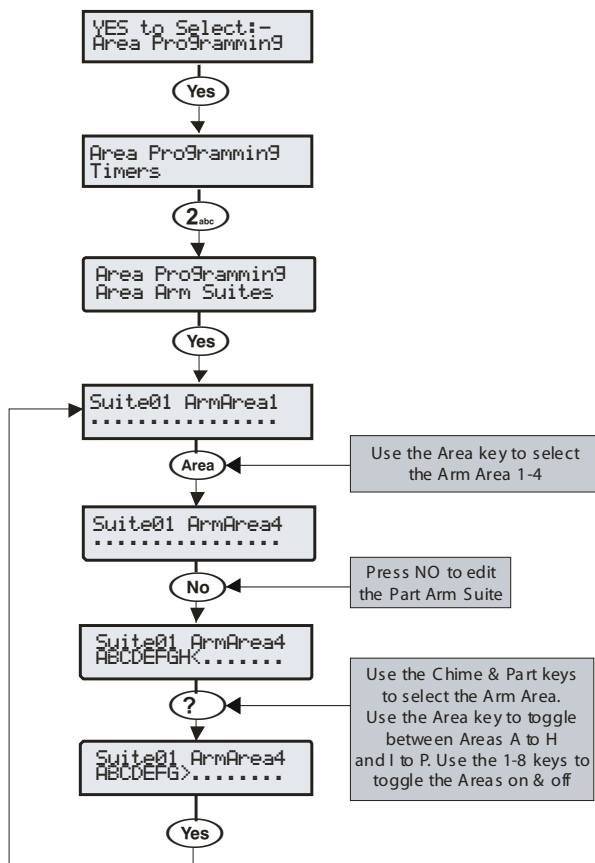

The 640 has 4 groups of 16 Arm suites. Any number of areas can be assigned to each suite. Areas assigned to an Area Arm Suite will be armed when the suite is selected, making it easier for the user to select multiple areas if required.

Example

Area Arm Suites could be useful in a domestic situation where the user wants to arm areas A and B at night but does not want to select each area individually.

- Areas 'A and B' would be assigned to 'Area Arm Suite 1'
- When the user wants to arm the system at night, 'Area Arm Suite 1' would be selected
- Areas A and B are automatically selected for arming

NOTE Descriptive text may also be assigned to the Area Arm Suite (see page 56 for details).

Area Arm Suite Controller

The suites can be assigned to keypads so that different combinations of areas can be armed or disarmed depending on which keypad is used (see page 73 for details) and operates as follows:

- Keypad 1 = Area Arm Suite 1, Keypad 2 = Area Arm Suite 2, Keypad 3 = Area Arm Suite 3 etc.

When a User code is entered at a keypad, one of the 'Area Arm Suites' is selected (depending on which keypad was used) and the areas contained within that suite arm using the arming mode for that suite, the keypad sounder will also follow the areas defined by the suite.

Area Suite Text

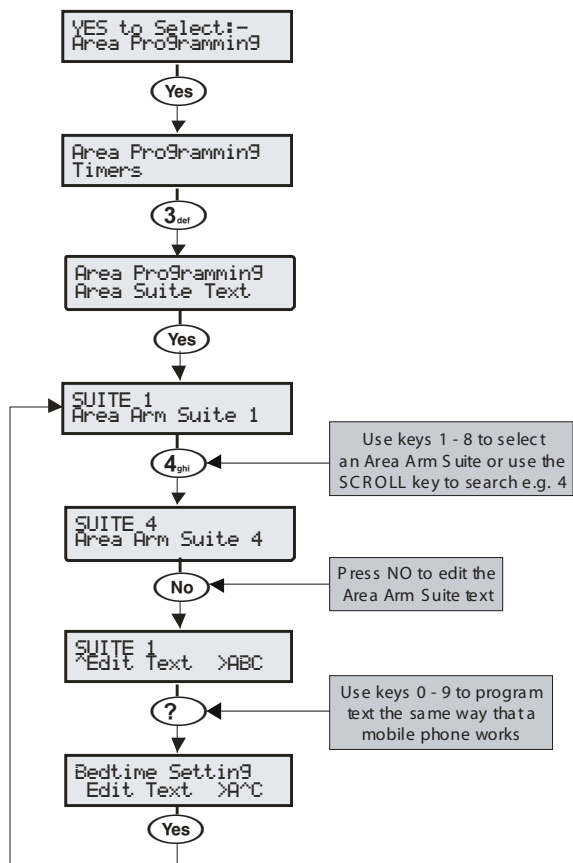

Text may be assigned to the Area Arm Suites to allow the user to select the suites by description instead of number. Up to 16 characters of text can be programmed for each suite.

Example

Text descriptions for the Area Arm Suites could be useful where more than one suite has been defined. The user wishes to arm areas A and B at night but is not too sure which suite to select.

- Areas 'A and B' would be assigned to 'Area Arm Suite 1' (see page 55 for details)
- When the user wants to arm the system at night, 'Area Arm Suite 1' would be selected
- Text will be displayed to confirm that the selected suite is correct i.e. 'Bedtime Setting'
- Areas A and B are automatically selected for armed

Text is programmed in a similar way to mobile phones. Select characters by pressing the corresponding key the appropriate number of times (to select a character on the same key, press to move the cursor along).

Suite Arm Modes

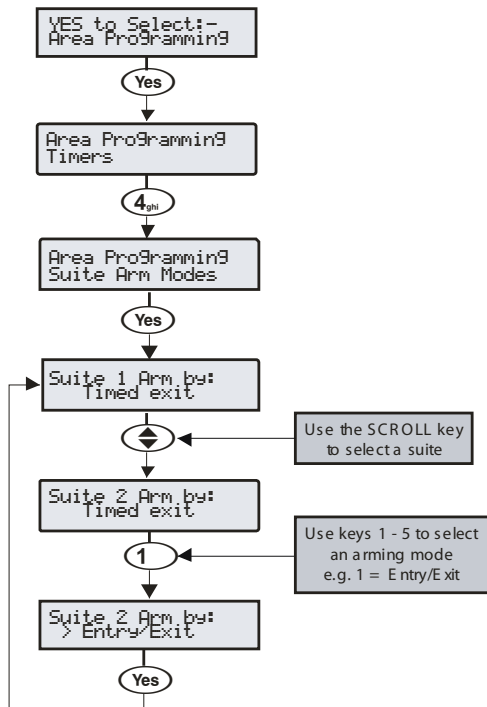

The way that an Area Arm Suite arms when selected, can be configured for any of the following options:

1 - Entry/Exit

The suite will arm after the 'Entry/Exit' door has been closed and the 'Exit Settle' timer has expired.

2 - Exit Term.

The suite will arm after the 'Entry/Exit' door has been closed, the 'Exit Terminator' button has been pressed and the 'Exit Settle' timer has expired.

3 - Timed Exit (Default for All Areas)

The suite will arm after the programmed 'Exit Time' has expired.

NOTE If an 'Exit Terminator' zone is activated at any point during the exit mode, any remaining exit time is cancelled and the area will arm immediately.

4 - Instant

The suite will arm instantly.

5 - Deferred

The suite will arm after the programmed 'Exit Time' has expired. However, if any zones not on the exit route are activated during the exit mode, the 'Exit Time' is restarted.

Area Options 24/48/88/168

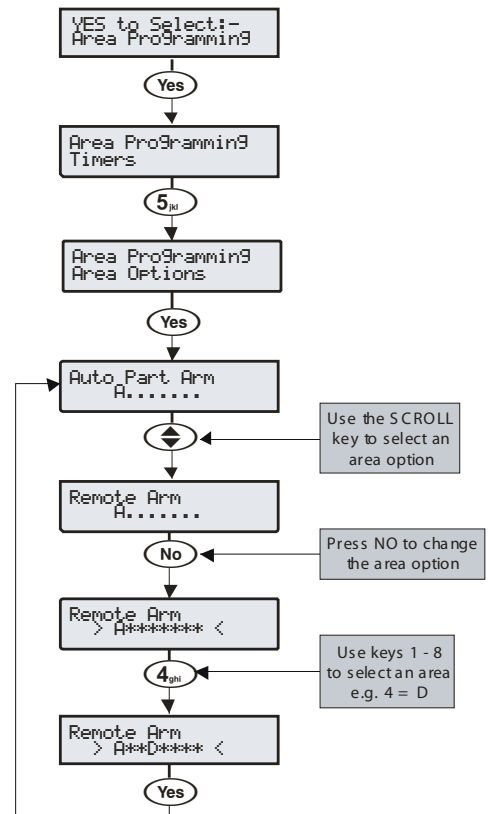

Area Options 640

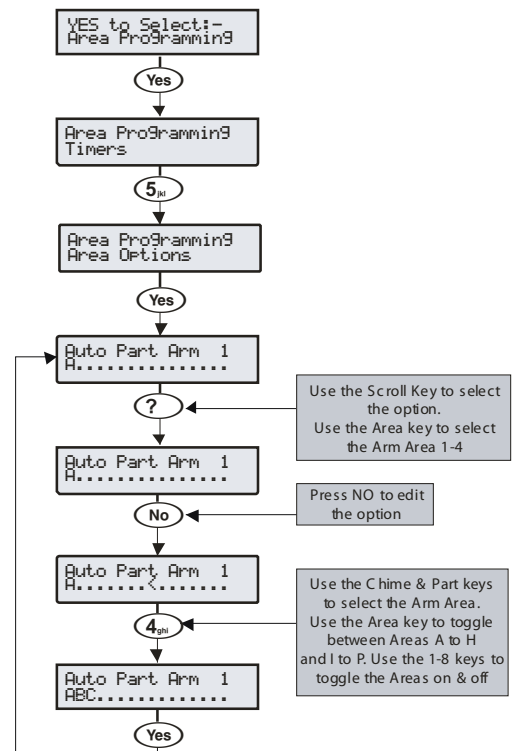

These options control how various features affect each area. Any number of areas can be assigned to each option.

1 - Auto Part Arm

Areas assigned to 'Auto Part Arm' will fully arm if an 'Entry/Exit' zone is activated during the exit mode and will 'Part Arm 1' if an 'Entry/Exit' zone is not activated during the exit mode.

Areas not assigned to 'Auto Part' will always fully arm.

2 - Part Arm Instant

Areas assigned to 'Part Arm Instant' will arm instantly when part arming.

Areas not assigned to 'Part Arm Instant' will use the area exit timer when part arming.

3 - Part Arm Silent

Areas assigned to 'Part Arm Silent' will never generate Exit tones when part arming.

Areas not assigned to 'Part Arm Silent' will always generate Exit tones when part arming.

4 - Remote Arm

Areas assigned to 'Remote Arm' can be armed remotely using the *Wintex UDL* software and a PC.

Areas not assigned cannot be armed remotely.

5 - Remote Disarm

Areas assigned to 'Remote Disarm' can be disarmed remotely using the *Wintex UDL* software and a PC.

Areas not assigned to 'Remote Arming' cannot be disarmed remotely.

6 - Panel Tamper

Areas assigned to 'Panel Tamper' will cause a Tamper alarm when the control panel cover is removed.

Areas not assigned to 'Panel Tamper' will never cause a Tamper alarm when the control panel cover is removed.

7 - Bell Tamper

Areas assigned to 'Bell Tamper' will cause a Tamper alarm when the Bell tamper loop is broken.

Areas not assigned to 'Bell Tamper' will never cause a Tamper alarm when the bell tamper loop is broken.

8 - Auxiliary Tamper

Areas assigned to 'Auxiliary Tamper' will cause a Tamper alarm when the Auxiliary tamper loop is broken.

Areas not assigned to 'Auxiliary Tamper' will never cause a Tamper alarm when the auxiliary tamper loop is broken.

9 - Panel Speaker

Areas assigned to 'Panel Speaker' will cause the control panel speaker to activate when those areas are in alarm, entry and exit etc.

Areas not assigned to 'Panel Speaker' will never cause the control panel speaker to activate when those areas are in alarm, entry and exit etc.

10 - Bell & Strobe op

Areas assigned to 'Bell & Strobe op' will cause the 'Bell/Strobe' output on the control panel to activate when an alarm occurs in those areas.

Areas not assigned to 'Bell & Strobe op' will never cause the 'Bell/Strobe' output on the control panel to activate when an alarm occurs in those areas.

11 - Alarms Eng Reset

Each area can be programmed for Engineer or User reset following an Intruder alarm. Areas Assigned to 'Alarms Eng Reset' will respond as follows:

- The assigned areas can only be reset using an Engineer code
If 'Anti-code Reset' is enabled (option 14) the assigned areas can also be reset using the Anti-code

Areas not assigned to 'Alarms Eng Reset' can be reset with any User code that is valid for those areas.

12 - Confirmed Reset

Each area can be programmed for Engineer or User reset following a Confirmed alarm. Areas Assigned to 'Confirmed Reset' will respond as follows:

- The assigned areas can only be reset using an Engineer code



NOTE If 'Anti-code Reset' is enabled (option 14) the assigned areas can also be reset using the Anti-code

Areas not assigned to 'Confirmed Reset' can only be reset with any User code that is valid for those areas providing that 'Alarms Eng Reset' (option 14) is also programmed for user reset.

13 - Tamper Eng Reset

Each area can be programmed for Engineer or User reset following a Tamper alarm (when the area is unarmed). Areas assigned to 'Tamper Eng Reset' will respond as follows:

- The assigned areas can only be reset using an Engineer code
- If 'Anti-code Reset' is enabled (option 14) the assigned areas can also be reset using the Anti-code

Areas not assigned to 'Tamper Eng Reset' can be reset with any User code that is valid for those areas.

14 - Anti-code Reset

Each area can be programmed for Anti-code Reset following an Intruder or Tamper alarm. Areas assigned to 'Anti-code Reset' will respond as follows:

- The assigned areas can be reset using the Anti-code as well as an Engineer code

Areas not assigned to 'Anti-code Reset' can only be reset using an Engineer code or User code.



NOTE Areas can only be assigned to 'Anti-code Reset' if they are also assigned to 'Alarms Eng Reset'.

15 - ATS Path Faults

Areas assigned to 'ATS Path Faults' (ATS = Alarm Transmission System) will respond as follows when an ATS fault occurs.

- All keypads will display 'ATS Path Fault'
- All keypads and speakers assigned to the same area as the 'ATS Path Fault' will generate a Service tone every 30 Seconds until the fault is acknowledged by the User entering a valid code for that area
- An assigned area can be armed, as long as 'Arm With No ATS' is also assigned to that area (see option 16). However, a warning will be given to indicate the problem

Areas not assigned to 'ATS Path Faults' will never be affected by an ATS fault.

16 - Arm With No ATS

Areas assigned to 'Arm With No ATS' (ATS = Alarm Transmission System) can be armed when an ATS fault occurs in those areas (see option 15).

Areas not assigned to 'Arm With No ATS' can never be armed when an ATS fault occurs in those areas (see option 15).

17 - AC Mains Fail

Areas assigned to 'AC Mains Fail' will respond as follows when an AC mains failure occurs.

- All keypads will display 'AC Mains Fail'
- All keypads and speakers assigned to the same area as the 'AC Mains Fail' will generate a Service tone every minute until the fault is acknowledged by the User entering a valid code for that area
- An assigned area can be armed, as long as 'Arm With AC Fail' is also assigned to that area (see option 18). However, a warning will be given to indicate the problem

Areas not assigned to 'AC Mains Fail' will never be affected by an AC mains failure.

18 - Arm with AC Fail

Areas assigned to 'Arm With AC Fail' can be armed when an AC Mains fail occurs in those areas (see option 17).

Areas not assigned to 'Arm With AC Fail' can never be armed when an AC Mains fail occurs in those areas (see option 17).

19 - Full Arm Coms

Areas assigned to 'Full Arm Coms' will respond as follows:

- If the selected area is fully armed and an Intruder alarm occurs in that area, Intruder alarm events (for that area) are reported to the Alarm Receiving Centre after any programmed 'Digi delay' has expired

Areas not assigned to 'Full Arm Coms' will never report Intruder alarm events to the Alarm Receiving Centre when they are fully armed.

20 - Part Arm Coms

Areas assigned to 'Part Arm Coms' will respond as follows:

- If an assigned area is part armed and an Intruder alarm occurs in that area, Intruder alarm events (for that area) are reported to the Alarm Receiving Centre after any programmed 'Digi delay' has expired

Areas not assigned to 'Part Arm Coms' will never report Intruder alarm events to the Alarm Receiving Centre when the area is Part armed.

21 - Unarm Fire Coms

Areas assigned to 'Unarm Fire Coms' will respond as follows:

- If an assigned area is unarmed and a Fire alarm occurs in that area, Fire alarm events (for that area) will be reported to the Alarm Receiving Centre

Areas not assigned to 'Unarm Fire Coms' will never report Fire alarm events to the Alarm Receiving Centre when the area is unarmed.



NOTE Fire alarm events are always reported to the Alarm Receiving Centre when the area is armed regardless of whether the area is assigned to this option or not.

22 - Unarm Tamp. Coms

Areas assigned to 'Unarm Tamp. Coms' will respond as follows:

- If an assigned area is unarmed and a 24Hr or Tamper alarm or reportable fault occurs in that area, the event will be reported to the Alarm Receiving Centre

Areas not assigned to 'Unarm Tamp. Coms' will never report 24Hr or Tamper alarm events or faults to the Alarm Receiving Centre when the area is unarmed.



NOTE 24Hr and Tamper alarm events are always reported to the Alarm Receiving Centre when the area is armed regardless of whether the area is assigned to this option or not.

23 - Auto Arm Areas

Areas assigned to 'Auto Arm Areas' will respond as follows:

- When an assigned area is disarmed, the 'Auto Arm Delay' timer will start (see page 62 for details)
- Every time a detector in that area is activated, the timer is restarted
- If the timer is allowed to expire i.e. no detectors in the assigned area are activated, the area will arm itself

Areas not assigned to 'Auto Arm Areas' will never try to arm themselves.

24 - Area A Foyer

Area A can be used as a common area (automatically arms last and disarms first). Areas assigned to 'Area A Foyer' will cause the panel to respond as follows:

- When all assigned areas are armed, Area A will automatically arm itself
- When any one assigned area is disarmed, Area A will automatically disarm itself

Areas not assigned to 'Area A Foyer' will not affect the automatic arming of area A.

25 - Log Part Omits

Areas assigned to 'Log Part Omits' respond as follows:

- When an assigned area is part armed, all the zones that are omitted for that area are logged in the event log

Areas not assigned to 'Log Part Omit' will never log the zones that are omitted in the event log when the area is part armed.

26 - Multi Knock Area

Areas assigned to 'Multi Knock Area' will respond as follows:

- Zones with the 'Double Knock' attribute will use the multiple knock value set up in system options for zone activations (see page 67 for details)

Areas not assigned to 'Multi Knock Area' will use the standard 2 knocks for zone activations.

For the 'Multi Knock Area' feature to work, the zone must be programmed with the 'Double Knock' attribute (see page 51 for details).

27 - UDL Keypad

Areas assigned to 'UDL Keypad' can be controlled i.e. armed, disarmed, reset etc. from the 'On Line Keypad' when using the *Wintex* software and a PC.

Areas not assigned to 'UDL Keypad' cannot be controlled i.e. armed, disarmed, reset etc. from the 'On Line Keypad' when using the *Wintex* software and a PC.

28 - Auto Chime (C2A)

Areas assigned to 'Auto Chime' will respond as follows:

- Zones assigned to the selected areas that have been programmed for 'Chime' will only chime when 'Custom Output 1, Stage A' is on

Areas not assigned to 'Auto Chime' will only chime when chime for that area is manually enabled by the user.

DD 243 Options

To comply with DD 243, during the normal entry delay, the control panel must prevent a Confirmed Intruder Alarm from being reported to the Alarm Receiving Centre.

If a Portable ACE i.e. Electronic Keyswitch, Key Fob, Tag, Swipe Card etc is being used for disarming, it is permissible for the Confirmed Intruder Alarm signal to be re-enabled after the entry delay has expired.

The following two options have been provided to ensure that the control panel can be programmed to comply with this standard if required.

WARNING

Owing to the ability to disable ALL of the confirmation facilities, the customer should be advised in writing by the alarm company that ALL means of alarm confirmation are disabled when the initial entry door is opened. The alarm company should then obtain written acceptance from the customer of the disabling of the means of alarm confirmation.

29 - Confirm in Entry

Areas assigned to 'Confirm in Entry' will respond as follows:

- If the entry mode is started for the selected area and a Confirmed Intruder alarm occurs in that area, Confirmed Intruder alarm events (for that area) are reported to the Alarm Receiving Centre

Areas not assigned to 'Confirm in Entry' will never report Confirmed Intruder alarm events to the Alarm Receiving Centre during the entry mode.



NOTE To comply with DD 243, areas must NOT be assigned to this option, thus preventing Confirmed Intruder Alarms from being reported to the Alarm Receiving Centre during the entry mode.

30 - Conf. after Entry

Areas assigned to 'Conf. After Entry' will respond as follows:

- Alarm confirmation is ONLY disabled for the duration of the Entry Time and is RE-ENABLED once the Entry Time has expired, after

which activation of a further two zones that are not on the entry route must occur before the Alarm Confirmation output will activate

Areas not assigned to 'Conf. After Entry' will never report Confirmed Intruder alarm events to the Alarm Receiving Centre after the entry delay has expired.



NOTE To comply with DD 243, areas must NOT be assigned to this option, thus preventing Confirmed Intruder Alarms from being reported to the Alarm Receiving Centre after the entry delay has expired.

If a Portable ACE i.e. Electronic Keypad, Key fob, Tag, Swipe Card etc. is used to disarm the system, it is permissible for the Confirmed Intruder Alarm signal to be re-enabled after the entry delay has expired. In this case, areas CAN be assigned to 'Conf. After Entry'.

31 - Part Arm Enabled

Areas assigned to 'Part Arm Enabled' can be Part Armed.

Areas not assigned to 'Part Arm Enabled' cannot be Part Armed.

32 - Bell Squawk

Areas assigned to 'Bell Squawk' will respond as follows:

- When all of the assigned areas are fully armed, the bell will activate once for 2 seconds, when any one of the assigned areas are disarmed, the bell will activate twice for 2 seconds and when any one of the assigned areas are disarmed following an alarm, the bell will activate five times for 2 seconds.

Areas not assigned to 'Bell Squawk' will not activate the Bell output when arming or disarming.

33 - FOB After Entry

Areas assigned to 'FOB After Entry' can only be disarmed with a Radio FOB once the Entry procedure has been started.

Areas not assigned to 'FOB After Entry' can be disarmed with a Radio FOB at any time.

34 - Armed = Coms

When Areas are assigned to 'Armed = Coms' the system will respond as follows:

- Communications and outputs (Alarm, Confirmed etc.) for ALL areas will only operate when all of the assigned areas are armed.

When No Areas are assigned to 'Armed = Coms' the system will respond as follows:

- Communications and outputs (Alarm, Confirmed etc.) for ALL areas will operate as normal.

35 - 2-Wire Smoke

Areas assigned to '2-Wire Smoke' will register a Fire Alarm when any 2-Wire Smoke detector activates.

Areas not assigned to '2-Wire Smoke' will not register a Fire Alarm when a 2-Wire Smoke detector activates.

36 - Faults Eng Reset

Each area can be programmed for Engineer or User reset following any Fault. Areas Assigned to 'Faults Eng Reset' will respond as follows:

- The assigned areas can only be reset using an Engineer code
If 'Anti-code Reset' is enabled (option 14) the assigned areas can also be reset using the Anti-code

Areas not assigned to 'Faults Eng Reset' can be reset with any User code that is valid for those areas.

37 - No ATS Eng Reset

Each area can be programmed for Engineer or User reset following a "No ATS Available" fault (ATS = Alarm Transmission System). Areas Assigned to 'No ATS Eng Reset' will respond as follows:

- The assigned areas can only be reset using an Engineer code
If 'Anti-code Reset' is enabled (option 14) the assigned areas can also be reset using the Anti-code

Areas not assigned to 'No ATS Eng Rst' can be reset with any User code that is valid for those areas.

38 - AC Fail Eng Reset

Each area can be programmed for Engineer or User reset following an AC Mains Fail. Areas assigned to 'AC Fail Eng Reset' will respond as follows:

- The assigned areas can only be reset using an Engineer code
If 'Anti-code Reset' is enabled (option 14) the assigned areas can also be reset using the Anti-code

Areas not assigned to 'AC Fail Eng Reset' can be reset with any User code that is valid for those areas.

39 - Mask When Armed

Areas assigned to 'Mask When Armed' will register a Masking fault when the selected areas are armed and a Masking Fault occurs.

Areas not assigned 'Mask When Armed' will never register a Masking fault when the selected areas are armed and a Masking Fault occurs

Time Arm Area

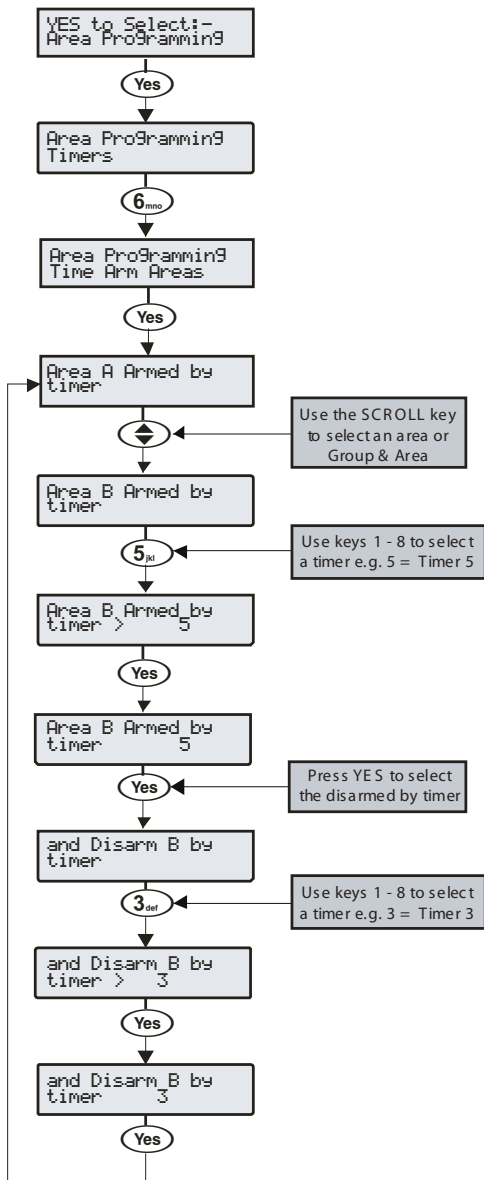

The alarm system as a whole or any number of individual areas can be automatically armed or disarmed using the built in control timers.

The 24 has 2 independent control timers, the 48 has 4 independent control timers the 88 168 have 8 independent control timers, and the 640 has 8 independent control timers for each of the 4 Area groups. These may be configured to switch on and off at different points of the day and operate on different days of the week (see page 68 for programming details).

Area Text

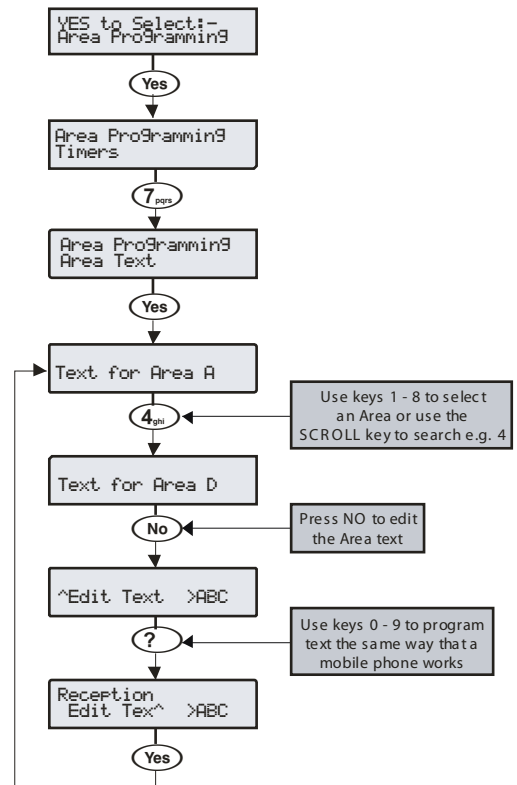

Text may be assigned to each of the areas on the system. This allows the user to select the areas by description instead of a letter. A maximum of 16 characters can be programmed for each of the areas.

Text is programmed in a similar way to mobile phones. Select characters by pressing the corresponding key the appropriate number of times (to select a character on the same key, press to move the cursor along).

5.3 Global Options

System Timers

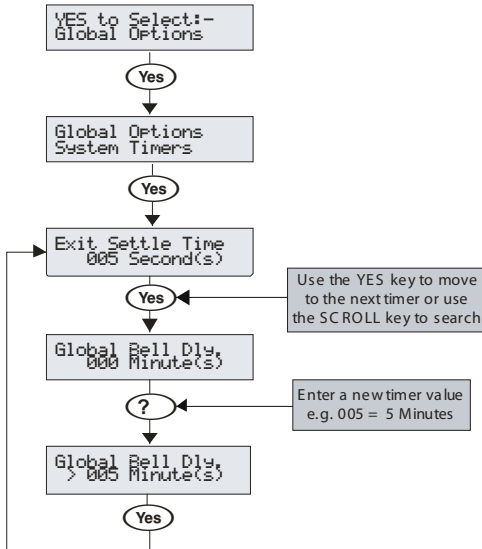

These timers control various timing and delay functions. Each timer can be programmed for any value between 000 and 999.

0 - Exit Settle Time

When using the 'Entry/Exit' or 'Exit Terminator' arming mode, some detectors along the exit route can remain active for a number of seconds following activation. This timer ensures that the detectors are given time to deactivate before the system/area arms.

1 - Global Bell Dly.

This timer controls the delay between an Intruder alarm occurring and the 'Bell/Strobe' output activating.

2 - Global Bell Dur.

This timer controls the duration of the 'Bell' output after an alarm has occurred and any programmed 'Global Bell Delay' time has expired.

3 - Double Knock Dly

If a zone has the 'Double Knock' attribute an alarm will only occur if the zone activates twice within this time window or once for the duration of this time window.



If multi knocks has been set up (see page 67 for details) the zone may have to be activated more than twice.

4 - Beam Pair Time

If a zone has the 'Beam Pair' attribute, an alarm will only occur if another zone with the 'Beam Pair' attribute (assigned to the same area) is activated within this time window.

5 - Activity Delay

If a zone has the 'Activity' attribute and it is not activated during this timer and 'Config. option 14' has been set to 'View Act. Fault' (see page 64 for details), it will be indicated to the user when they try to arm the system/area.

6 - Abort Delay

When an Intruder alarm occurs this timer is started, if the area is disarmed within this time window an 'Abort' event will be reported to the Alarm Receiving Centre. If the system is disarmed after this period the 'Abort' event is not reported.

7 - Courtesy Time

This timer controls the duration of the 'Courtesy' output type. The courtesy output activates whenever a keypad is being used and during the entry mode.

8 - Defer Arming By

If an area tries to 'Time Arm' and a valid User code is entered, this timer is started and the 'Time Arming' procedure is postponed. When this timer expires, the system/area will try to arm itself again.

9 - Auto Arm Delay

When an area assigned to 'Auto Arm Areas' is disarmed (see page 59 for details) this timer is started. Every time a detector in that area is activated, the timer is restarted. If the timer is allowed to expire i.e. no detectors in the assigned area are activated, the area will arm itself.

10 - Menu Time Out

This timer controls the length of time that a user can remain in a menu before the system automatically returns to the normal day mode.

11 - Pulse Period 1

This timer controls how long any output with the 'Pulse Period 1' attribute assigned to it will activate for.

12 - Pulse Period 2

This timer controls how long any output with the 'Pulse Period 2' attribute assigned to it will activate for.

13 - Pulse Period 3

This timer controls how long any output with the 'Pulse Period 3' attribute assigned to it will activate for.

14 - ATS Fault Delay

This timer controls the delay between a line fault occurring and an audible indication being generated by the system.

15 - AC Off Delay

This timer controls the delay between an AC Mains failure occurring and an audible indication being generated by the

16 - Batt Test Period

This timer controls the frequency of the dynamic battery test.

17 - Batt Test Time

This timer controls how long the dynamic battery test is carried out for.

18 - Soak Test Time

This timer controls the number of days a zone with the 'Test' attribute will remain on test for.

19 - Service Interval

This timer controls the frequency of the 'Service Required' condition occurring.

20 - Test Call Every

This timer controls how often a test call is made to the monitoring station. 024 = daily etc.

21 - Min. Random Time

This timer controls the minimum length of time that the 'Random' output attribute will activate for.

22 - Max. Random Time

This timer controls the maximum length of time that the 'Random' output attribute will activate for.

23 - Door Strike Time

This timer controls the length of time that the 'Door Strike' output will activate for whenever a code with the 'Door Strike' attribute is entered.

24 - Zone Response

This timer controls the length of time that a zone with the 'Quick Resp.' attribute, has to be activated for, in order to be recognised by the control panel.

25 - Keypad PA Delay

When keypad 'option 6' is programmed as 'PA Delayed' (see page 73 for details), and a keypad PA alarm (1 & 3) is activated, this timer starts. If a User code is entered before this timer expires, no PA alarm will occur. However, if a User code is not entered before this timer expires, a PA alarm will occur.

26 - Confirmation Dly

When an Intruder alarm occurs, this timer starts. If a second (different) zone is activated within this time window, the 'Confirmed' output will activate. When this timer expires, the 'Confirmed' output will no longer activate.

27 - Warning Delay

When a Custom zone with the 'Warning Req' attribute (see page 52 for details) activates, this timer is started. If the zone is still active when this timer expires a warning tone or alarm will occur and the Warning Output (see page 80 for details) will activate.

28 - Keypad Lock Time

When code tampers are programmed to lockout the keypad (see page 64 for details), the keypad will lock out for the duration of this timer.

29 - Eng. log off Dly

This timer starts when an Engineers code is entered. When the timer expires the engineer is automatically logged out of engineer's mode. This timer is suspended if there are tamper faults on the system allowing the engineer to remain in engineer's mode indefinitely whilst on site.

30 - Fire Bell Delay

This timer starts when a fire alarm is generated in a particular area. When the timer expires sounders are activated in ALL areas.

31 - Forced Entry Dly

When a zone with the 'Guard' attribute (see page 51 for details) activates, this timer is started. For the duration of this timer, any 'Entry/Exit 1 or 2' zone with the 'Entry/Exit 2' attribute (see page 51 for details) will become a 'Guard' zone. When this timer expires, the 'Entry/Exit 1 or 2' zone will revert back to its normal mode of operation.

32 - Supervision Time

This timer controls the frequency at which the RadioPLUS detectors are required to report in to the control panel.

33 - Poll IP Every

This timer controls the frequency that the ComIP Polls the ARC.

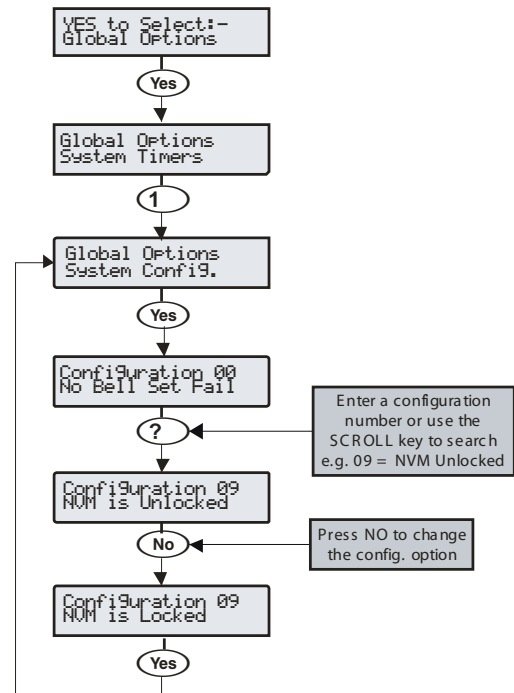
System Config.

These options control how various system functions work.

00 - No Bell Arm Fail

If an area fails to arm, an Internal alarm will occur and the 'Strobe' output will activate.

Bell on Arm Fail

If an area fails to arm, an Internal alarm will occur and the 'Bell' output will activate for 10 seconds.



The 'Strobe' output will also activate for 5 seconds to indicate that the system has armed/disarmed.

01 - Bell is an SAB

The 'Bell' output on the control panel applies 0V when active.

Bell is an SCB

The 'Bell' output on the control panel removes 0V when active.

02 - Clock is 24Hr

The system time is displayed in the 24-Hour format.

Clock is 12Hr (Default)

The system time is displayed in the 12-Hour format.

03 - Auto BST/GMT

The system clock will adjust itself at the beginning and the end of the summer (the clock will automatically gain 1Hr on the last Sunday in March and lose 1Hr on the last Sunday in October).

Manual BST/GMT

The system clock will not adjust itself at the beginning and the end of the summer (the clock will have to be adjusted manually).

04 - View Armed Areas

When the system is part armed, the areas that are armed are displayed and alarm information is displayed before a valid User code is entered.

Hide Armed Areas

When the system is part armed, the areas that are armed are not displayed and alarm information is only displayed after a valid User code has been entered.

05 Global Bell Time

When all areas are armed, the system uses the 'Global Bell Delay' and 'Global Bell Duration' timers (see page 62 for details).

Area Bell Time

When all areas are armed, the system uses the 'Area Bell Delay' and 'Area Bell Duration' timers (see page 54 for details).

06 - 24Hr Omit Global

'24-Hour' type zones can be omitted from any keypad.

24Hr Omit Local

Only keypads assigned to the same area as the '24-Hour' type zones can be used to omit the zone.

07 - Remove Omits

When zones have been 'Omitted' by a user, the zones will be automatically reinstated by the system when the area they are assigned to is next disarmed.

Leave Omits

When zones have been 'Omitted' by a user, the zones will remain omitted until the user reinstates them.

08 - Override Com Dly

If an area is 'Fully' armed and an Intruder alarm occurs in that area, Intruder alarm events (for that area) are reported to the Alarm Receiving Centre immediately.

Enforce Com Dly

If an area is 'Fully' armed and an Intruder alarm occurs in that area, Intruder alarm events (for that area) are reported to the Alarm Receiving Centre after any programmed 'Coms delay' has expired (see page 54 for details).

09 - NVM is Unlocked

The factory default settings can be reloaded by pressing the Factory Restart button during power up.

NVM is Locked

The factory default settings cannot be reloaded by pressing the factory default button during power up.



If the NVM is locked and the Engineer User code has been lost or forgotten, the PCB will have to be replaced.

10 - Engineer Only

Access to the Engineers Programming menus can be obtained by just entering the Engineer User code.

User + Engineer

Access to the Engineers Programming mode can only be obtained, if a User (with the 'Engineer Access' attribute) has authorised engineer access (see page 110 for details).

11 - Chime Audible

Zones programmed with the 'Chime 2 or 3' attribute will only generate a Chime tone.

Chime Visible (Default)

Zones programmed with the 'Chime 2 or 3' attribute will generate a Chime tone. The keypad will also display the number of the zone that was activated.

12 - Omit Tamper No

A user cannot omit Tamper faults on a zone.

Omit Tamper Yes

A user can omit Tamper faults on a zone.

13 - Offline Printing

If a printer is plugged onto the control panel, nothing will be printed unless a printout is requested (see page 120 for details).

Online Printing

If a printer is plugged onto the control panel, anything that is logged in the event log is also printed at the same time.

14 - Hide Act. Fault

If a zone with the 'Activity' attribute is not activated during the 'Activity Delay' time window, the area that the zone is assigned to can still be armed. However, this fault will be indicated to the user when they try to arm the area.

View Act. Fault

If a zone with the 'Activity' attribute is not activated during the 'Activity Delay' time window, the area that the zone is assigned to cannot be armed. This situation can only be overcome by activating the zone.

15 - Hide Exit Errors

If a user tries to arm an area and there are zones activated, the exit mode will continue (giving a visual and audible indication that there is a problem).

View Exit Error

If a user tries to arm an area and there are zones activated, the exit mode is suspended until all of the zones are secure.

16 - Enable Code Tamper

24 invalid key presses on a keypad will cause a Code Tamper condition (see option 17).

No Code Tamper

A Code Tamper condition will never occur when the keys on a keypad are pressed more than 24 times.

17 - Code Tamper Alarm

A Code Tamper condition will cause a Tamper alarm in the areas that the keypad is assigned to.

Code Tamper Lockout

A Code Tamper condition will cause the keypad to lockout for the duration of the keypad lockout timer (see page 62).



Option 16 above must be set to enable code tampers in order for this option to work.

18 - Areas A-H & I-P

The first 8 areas will be displayed as letters A through to H and the last 8 areas will be displayed as letters I through to P.

Areas 1-8 & I-P

The first 8 areas will be displayed as numbers 1 through to 8 and the last 8 areas will be displayed as letters I through to P.

19 - Auto Area Select

When an Engineers code is entered to gain access to the programming mode, ALL Zones and Tampers are disabled i.e. if any Tampers, PA, Fire or Medical Alarms are activated - NOTHING WILL HAPPEN.

Man. Area Select

When an Engineers code is entered to gain access to the programming mode, the Engineer will have to select which areas are going to be worked on.



Zones and Tampers are only disabled for the selected areas all other areas will respond to zone activations and tampers as normal.

20 - Predictive Text

When in text editing mode, the control panel will automatically select predictive text.

Manual Text Edit

When in text editing mode, the control panel will automatically select normal text.

21 - Short = Tamper

The control panel will see a zone that is in the short circuit condition as a 'Tamper'.

Short = Active

The control panel will see a zone that is in the short circuit condition as 'Active'.

22 - R/R=Reset Only

When 0V is applied to the control panel R/R input, any areas programmed for anti-code reset (see page 58 for details) that are in alarm, will be reset.

R/R=Silence/RST

When 0V is applied to the control panel R/R input any areas programmed for anti-code reset (see page 58 for details) that are in alarm, will be silenced. When 0V is applied to the R/R input a second time, the areas will be reset (this would normally be used when Audio Verification is required).

23 - User Code Pulse

Entering a user code which has an associated user output will cause the output to activate for the duration of the door strike timer.

User Code Latch

Entering a user code which has an associated user output will cause the output to toggle from off to on or from on to off.

24 - Timed Test Call

A test call to the Alarm Receiving Centre will occur every time the 'Test Call Every' timer expires.

Test Call = CT4

A test call to the Alarm Receiving Centre will occur every time 'Control Timer 4' activates.

25 - Batt Test Timed

A battery test will occur every time the 'Batt Test Period' timer expires.

Batt Test = Disarm

A battery test will occur every time the system is disarmed or after the 'Batt Test Period' timer has expired (whichever occurs first).

26 - Bell = 1st Alarm

The 'Bell' and 'Strobe' outputs will activate after an Intruder alarm (1st Alarm) occurs.

Bell = 2nd Alarm

The 'Bell' and 'Strobe' outputs will activate after a Confirmed alarm (2nd Alarm) occurs.

27 - SNDR = 1st Alarm

The internal sounders will sound after an Intruder alarm (1st Alarm) occurs.

SNDR = 2nd Alarm

The internal sounders will sound after a Confirmed alarm (2nd Alarm) occurs.

28 - Conf. = Instant

Following the arming of the system/area, if two zones activate (causing a Confirmed alarm), the signal will be reported to the Alarm Receiving Centre immediately.

Conf. = Delayed

Following the arming of the system/area, if two zones activate (causing a Confirmed alarm), the signal will only be reported to the Alarm Receiving Centre after the 'Abort' time has expired.

29 - Abort=Eng.Reset

An Intruder alarm that is aborted can only be reset by an Engineer/Anti-code.

Abort=User Reset

An Intruder alarm that is aborted can be reset by any User.

30 - Auto AV Output

When using the AV Module, if a microphone is remotely selected, the corresponding output automatically activates.

Manual AV Output

When using the AV Module, if a microphone is remotely selected, the corresponding output must be activated manually.

31 - Clock = 50Hz

The internal clock on the control panel runs from the 50Hz main frequency.

Clock = Crystal

The internal clock on the control panel runs from the built-in crystal.

32 - 80 Column Print

Select this option when connecting an 80 Column printer to the control panel.

40 Column Print

Select this option when connecting an 40 Column printer to the control panel.

33 - Disable Text

Areas that are armed are displayed as letters on the bottom line of the display i.e. 'Armed: AB.D...'

Enable Text

Areas that are armed are displayed using their assigned text on the bottom line of the display i.e. 'Armed: Garage', 'Office' etc. (a different area is displayed every second).

34 - EN50131 Disabled

The Control Panels EN50131 options are disabled.

EN50131 Enabled

Keypad display 'blanking' is enabled i.e. the keypad will only display the time, date and the banner message. If information is available to be viewed i.e. AC Mains Fail, Line Fault, System Faults etc. the keypad will bleep every 30 seconds and display 'System Alerts', this information can only be viewed after a valid user code has been entered. The keypad display will then 'blank' again 30 seconds after.

The bell output will not activate, if an alarm occurs during the entry mode.



NOTE *Duress Codes can only be programmed by an engineer*

35 - 2nd Zone = Confirm

After the entry timer has expired, activation of 2 more zones is required to generate a Confirmed alarm

1st Zone = Confirm

After the entry timer has expired, activation of 1 more zone is required to generate a Confirmed alarm

36 - Keypads Global

Keypads show information for all areas.

Keypads Local

Keypads only show information that is relative to the area that the keypad is assigned to.

37 - Panel Grade 3

All options relating to PD6662: 2004/EN 50131-1 Grade 3 are enabled automatically. Also, the Anti-code reset becomes a 6-digit number and all user codes can only be programmed as 5 or 6 digits.

Panel Grade 2

All options relating to PD6662: 2004/EN 50131-1 Grade 3 that are not required for Grade 2 are disabled automatically. Also, the Anti-code reset becomes the standard 4 digit number and all user and engineer codes can be 4, 5 or 6 digits.

38 - Disable FOB PA

When a 'Smartkey' Transmitter FOB is being used with the alarm system, the Panic Alarm (PA) function i.e. Pressing buttons 1 and 2 together, is disabled.

Enable RF FOB PA

When a 'Smartkey' Transmitter FOB is being used with the alarm system, the Panic Alarm (PA) function i.e. Pressing buttons 1 and 2 together, is enabled.

39 - Armed Mask=Fault

If an Anti-masking signal is detected when the system is armed, the control panel will generate a Fault response.

Armed Mask=Alarm

If an Anti-masking signal is detected when the system is armed, the control panel will generate an Alarm response.

40 - Silent RF FOB PA

PA alarms generated from a wireless FOB will cause a silent alarm.

Audible FOB PA

PA alarms generated from a wireless FOB will cause a Audible alarm.

41 - Monitor PSU Battery

Battery faults from the PSU200XP are monitored.

No PSU Batt Flts

Battery faults from the PSU200XP are not monitored.

42 - Exp Loss Tamp

An expander lost event will generate a tamper alarm.

No Exp Loss Tamp

An expander lost event will generate a fault condition.

43 - Soak Test Warn

If zones have been placed on Soak Test, a warning will be shown to the user at the time of arming.

No Soak Test Warn

If zones have been placed on Soak Test, no warning will be shown to the user at the time of arming.

44 – FOB Batt Warn

When during arming if a low fob battery event is received the arming will be cancelled and the keypad will generate a warning, the user will have to affirm the “Arm with faults” on the keypad before arming will proceed. Both the low battery and the user acknowledgement will be logged.

No FOB Batt Warn

When during arming if a low fob battery event is received the arming will proceed but the low fob battery will be logged in the event log.

45 – Entry Stray

Enables Entry Stray to comply with BS8243 or EN50131-1. This flag is selectable by configuring option 46.

No Entry Stray

Disables Entry Stray

46 – BS Entry Stray

A second alarm condition during the alarm notification period will immediately expire the alarm notification timer. This will cause a confirmed alarm message to be set to the arc and logged in the event log.

No BS Entry Stray

Second and subsequent alarm conditions during the alarm notification period have no effect on the timer.

47 – Tamp No Confirm

If a device has caused an unconfirmed alarm then a tamper from that same device will not cause a confirmed alarm.

Tamper Confirm

If a device has caused an unconfirmed alarm then a tamper from that same device will cause a confirmed alarm.

48 – Radio 2 Step Arm

When arming using a wireless FOB. The arming procedure requires two steps.

Radio 1 Step Arm

When arming using a wireless FOB. The arming procedure requires one step.

49 – Radio Step 1 Zone

When configuration option 48 is programmed as ‘Radio 2 Step Arm’ the second step of the arming procedure is the activation of any zone programmed as ‘Guard Access’.

Radio Step 2 RKP

When configuration option 48 is programmed as ‘Radio 2 Step Arm’ the second step of the arming procedure is confirmation via the keypad.

50 – Conf Hold Up EN

Once a PA zone is activated the hold-up timer is started (See Global System Timers for Confirmed PA Timer), the confirmed alarm will generate if one of the following happens, another PA Zone activated or a tamper from a device, multi-action PA or a global tamper within the timer period.

No Conf Hold Up

No confirmed hold-up will be generated.

51 – Max Log msgs 3

Log events from individual sources are limited to 3.

No Max Log msgs

Log events from individual sources are not limited to 3.

52 – Code Entry Timed

When 10 failed code attempts have been made, the keypad will lock out for 90 seconds. If the panel is grade 2 a further 10 failed code entry attempts the will keypad will locked out for 90 seconds. If the panel is grade 3 then after every single failed code entry attempt the keypad will lock out for 90 seconds. After 21 failed code entry attempts the code tamper alarm is generated and logged.

No code Ent Time

Failed code entry attempts will not lock out keypads or generate a code tamper

53 – Enable PD6662:2010

The panel will be defaulted to operate according to PD6662:2010

Disable PD6662:2010

The panel will operate according to the requirements of PD6662:2004

System Options

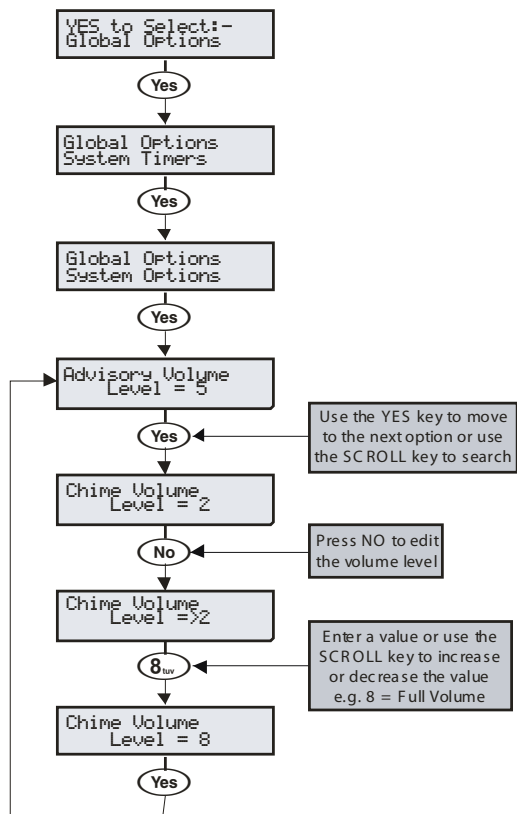

These options control various system functions.

0 - Advisory Volume

Controls the volume of advisory tones (entry/exit etc.) from loudspeakers connected to the control panel (Alarm tones are always full volume). 1 = min, 8 = max.

1 - Chime Volume

Controls the volume level of Chime tones from ALL loudspeakers. 1 = min, 8 = max.

2 - No. Of Re-Arms

Controls the number of times that a zone will re-arm. Once the re-arm limit has been reached, the zone is 'Locked Out' and will not cause any further Intruder alarms.

3 - Anti-code Resets

Limits how many times a user can perform an Anti-code reset. Once this limit is been reached, the system can only be reset using an Engineer code. This counter is reset every month or whenever an Engineers code is entered.

4 - Multiple Knocks

Controls how many times, a zone with the 'Double Knock' attribute, must be activated, before an alarm occurs. The multiple knock count can be applied to zones on an area basis, see page 59 for details.

5 - Clock Adjustment

Adjusts the accuracy of the clock by subtracting or adding time in seconds at midnight every night. 0 = -50, 50 = 0 (no correction), 100 = +50.

6 - Quick Count

Set the number of 10milli Second pulses that are required within 30 Seconds in order for a zone with the 'Quick Response' attribute to activate.

7 - Modem Level

When using a Com2400 this option allows adjustment to the attenuation of the modem.

Modem Level	2	1	0	7	6	5	4	3
Attenuation (dB)	+4	+2	0	-2	-4	-6	-8	-10

8 - Language Selection

Various languages are available for the control panels. Listed below are the language sets, and the languages available. The Language set

number is defined on the product label where applicable by LS1, LS2 or LS3. The 640 has all languages listed available in the control panel.

24/48/88/168		
LS1	LS2	LS3
English UK	English UK	English UK
English	English	English
Swedish	Spanish	Russian
French	Italian	Slovenian
Belgian Dutch	Polish	Czech
Text Danish	Hungarian	German
Norwegian		Estonian
Finnish		

640	
English UK	Italian
English	Polish
Swedish	Hungarian
French	Russian
Belgian Dutch	Slovenian
Danish	Czech
Norwegian	German
Finnish	Estonian
Spanish	

9 - Country Codes & Defaults

Country codes are used to define Telecoms requirements, and defaults are loaded if available when the country code is chosen. The following country codes are available and show the associated defaults loaded by the panel.

Country	Code	Defaults
Export	0	UK
Russia	7	UK
South Africa	27	South Africa
Netherlands	31	UK
Belgium	32	Norway
France	33	France
Spain	34	UK
Hungary	36	UK
Italy	39	UK
Czech	42	UK
UK	44	UK
Denmark	45	Denmark
Sweden	46	Sweden
Norway	47	Norway
Poland	48	UK
Germany	49	UK
Finland	58	Norway
Australia	61	Australia
Test	97	UK
Themes	98	UK
Chinn	99	UK
Estonia	172 (372)	UK

Monitor Hardware

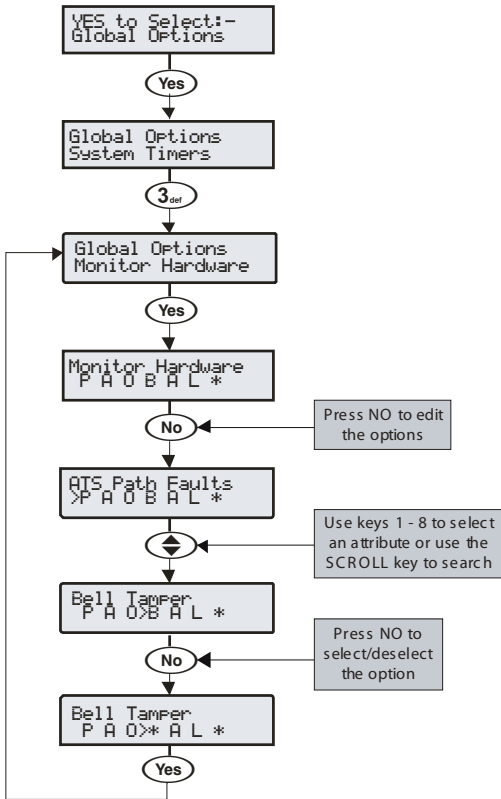

The control panel monitors many inputs for fault conditions i.e. the panel lid tamper, bell tamper, aux fuse etc.

Each one of these options can be disabled to overcome problems related to the devices being monitored.

P - ATS Path Faults

The Alarm Transmission System is monitored for faults.

A - AC Power Failure

The AC Mains is monitored for faults.

O - Power Outputs/Charger

The Power outputs and charger are monitored for faults. see page 106 for the list of Power Outputs monitored)

B - Bell Tamper

The external sounder tamper loop is monitored for faults.

A - Aux Tamper

The auxiliary tamper loop is monitored for faults.

L - Panel Lid Tamper

The control panel lid tamper is monitored for faults.

B - Battery Faults

The battery is monitored for faults.

Control Timers

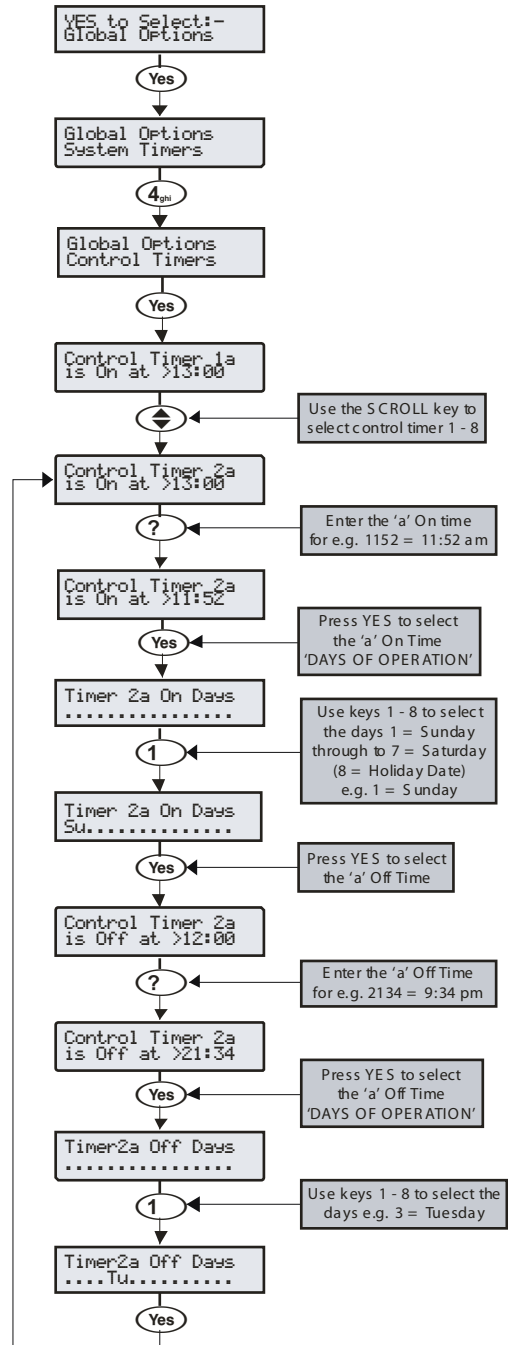

The 48 has 4 control timers and the 88 ,168 and 640 have 8 control timers. Each timer has two ON and OFF times (a & b), and can be programmed to operate on any day of the week. Once configured, the timers can be used to arm or disarm areas, lockout users and control outputs.



When programming the Control Timers ON time, pressing **Chime** will bring a '*' up on the display. This '*' indicates that the internal sounders will chime every time the Control Timers ON time is reached.

When programming the Control Timers DAYS of operation, pressing **8 del** will bring 'HO' up on the display. This 'HO' indicates that the control timer will operate on any programmed Holiday date.

System Text

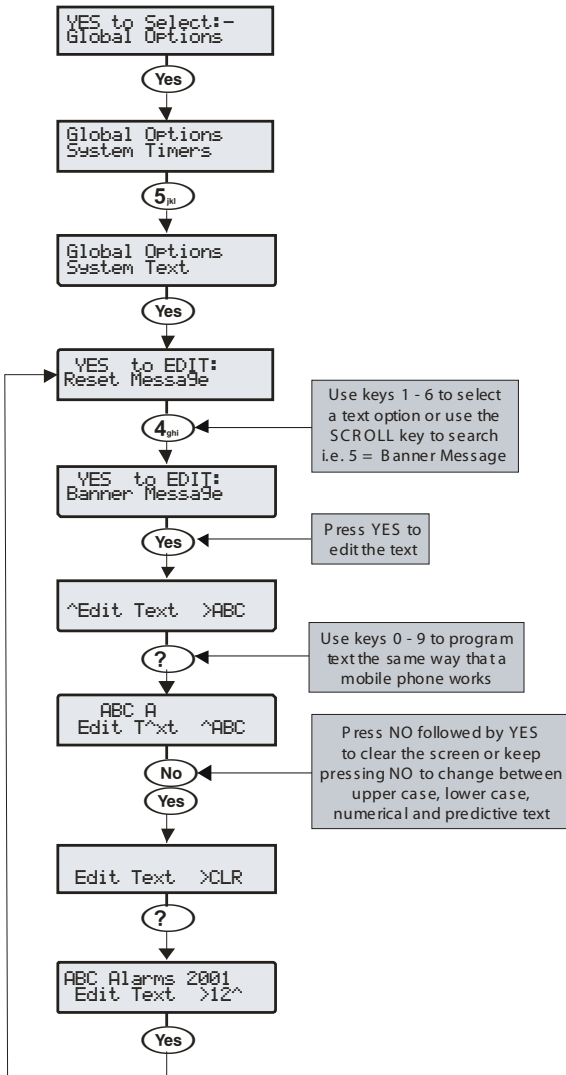

The system has 7 programmable messages.

1 - Reset Message

This 32-character message is displayed whenever the control panel requires an Engineer reset.

2 - Anti-code Msg.

This 32-character message is displayed whenever the control panel requires a Anti-code Reset.

3 - Service Message

This 32-character message is displayed whenever the control panel requires Daytime reset.

4 - Location Text

This 32-character message is displayed whenever the engineer views the location text in 'Engineer Utils'.

5 - Banner Message

This 16-character message is displayed above the time and date whenever the control panel is unarmed or fully armed.

6 - Part Arm Banner

This 16-character message is displayed above the time and date whenever the control panel is part armed.

7 - Printer Header

This 16-character header will be printed whenever a log printout is taken from the control panel or a Short Message Service (SMS) text message is sent to a mobile phone.

Part Arm Text

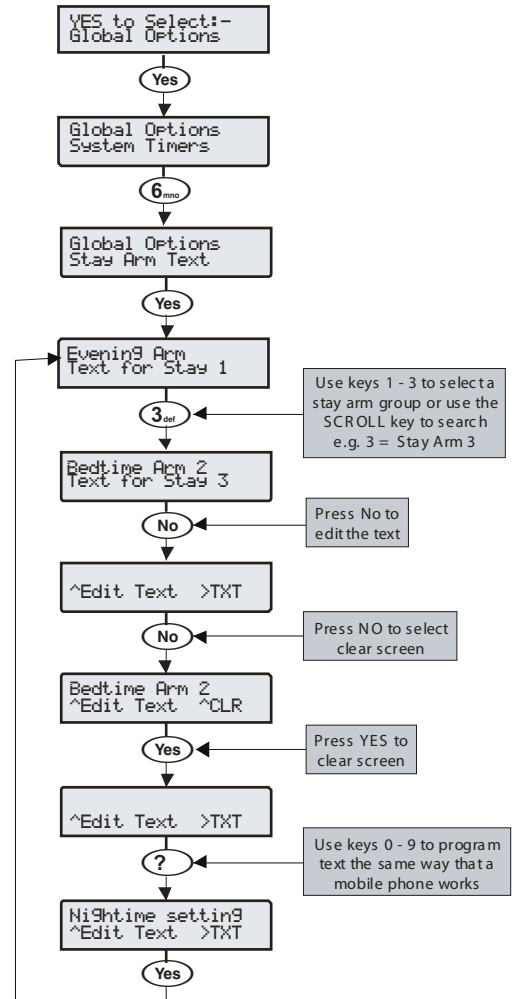

Text may be assigned to Part Arm 1, 2 or 3 to allow the user to select the correct Part Arm by description instead of number. A maximum of 16 characters can be programmed for each of the Part Arms.



The 3 Part Arm messages are global messages and will appear whenever one of the part arms are selected regardless of which area is being part armed.

Text is programmed in a similar way to mobile phones. Select characters by pressing the corresponding key the appropriate number of times (to select a character on the same key, press to move the cursor along).

Holiday Dates

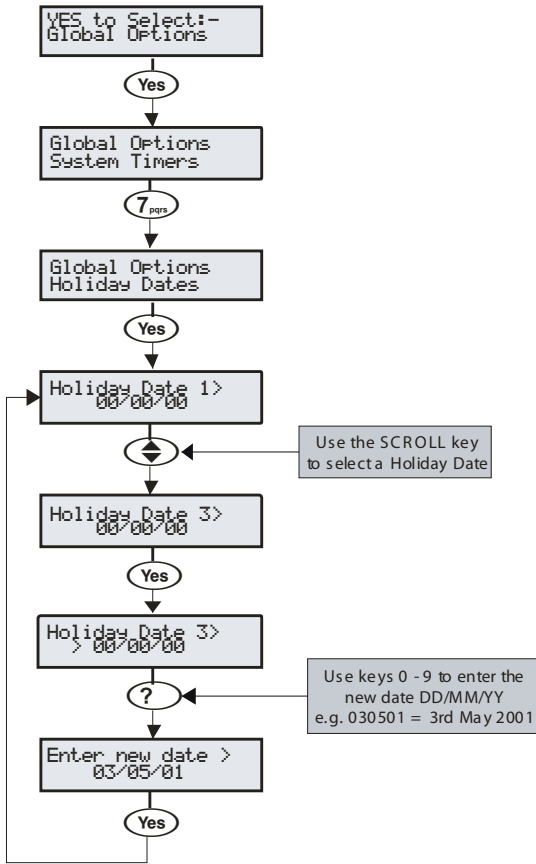

The system has 8 programmable holiday dates.

The holiday dates are pre-defined dates on which the Control Timers will not operate.

Example

Control Timer 1 is programmed to operate between the hours of 8pm and 8am on Monday through to Friday (for the purpose of arming the control panel).

Because Bank Holidays normally fall on Mondays the panel would disarm itself leaving the premises unprotected.

- Christmas day 2001 falls on a Tuesday
- Under normal conditions the Control Timer will operate on a Tuesday
- The 25/12/01 is programmed as a Holiday Date
- The Control Timer does not operate on Tuesday 25th December 2001 and the premises remains protected at all times

Speaker Tones

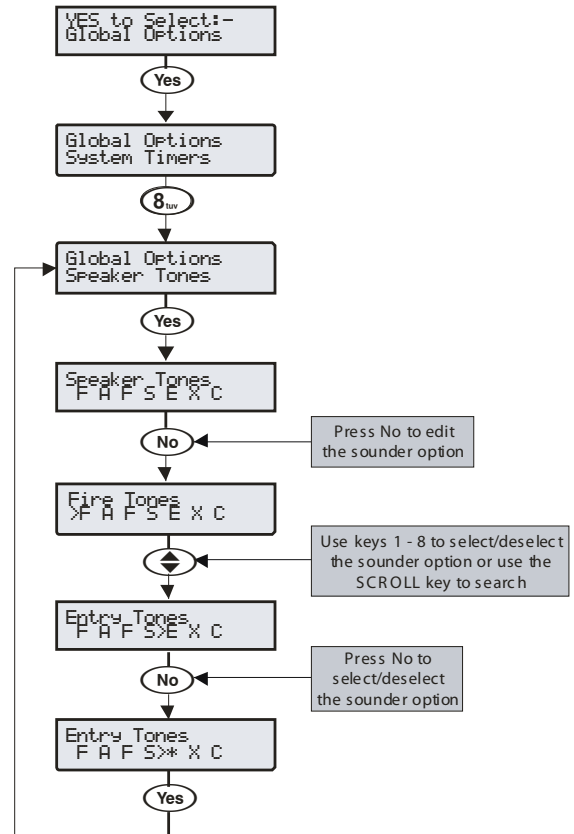

The speaker output on the control panel can be programmed so that certain types of tones are not generated. When deselected, Fire, Alarms, Fault, Service, Entry, Exit and Chime tones will not be heard.

Select tones by pressing keys 1 to 8 (a letter on the display means the tone is selected, a Dot on the display means the tone is not selected).

F - Fire Tones On

Fire alarm tones will be generated by the control panel sounder/speaker.

A - Alarm Tones On

Intruder alarm, Tamper alarm and PA alarm tones will be generated by the control panel sounder/speaker.

F - Fault Tones On

Fault tones will be generated by the control panel sounder/speaker.

S - Service Tone On

Service and Warning tones will be generated by the control panel sounder/speaker.

E - Entry Tones On

Entry tones will be generated by the control panel sounder/speaker.

X - Exit Tones On

Exit tones will be generated by the control panel sounder/speaker.

C - Chime Tones On

Chime 1, 2 and 3 tones will be generated by the control panel sounder/speaker.

PC Output Text

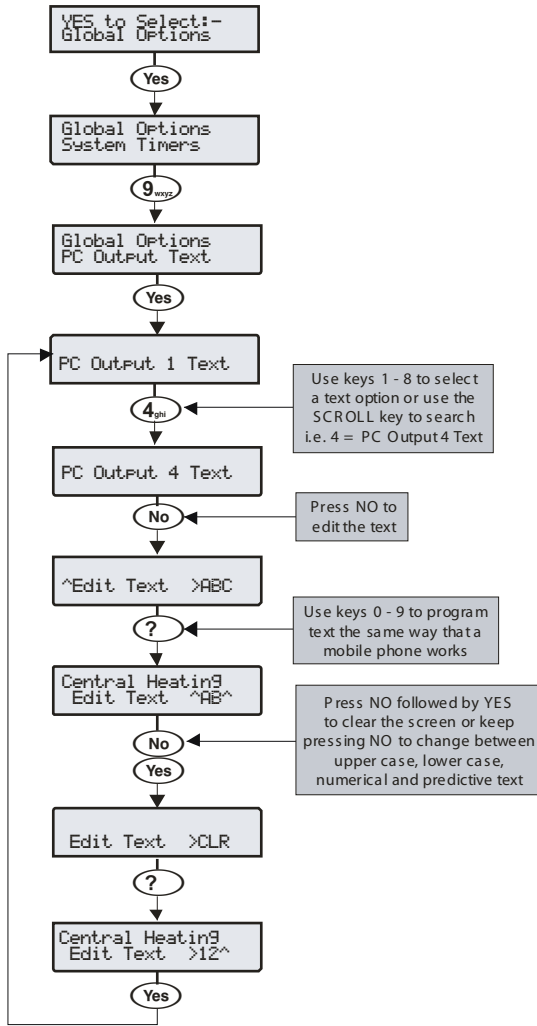

Text may be assigned to PC Control Outputs 1 to 8 to allow the user to select the correct Output by description instead of number. A maximum of 16 characters can be programmed for each of the PC Outputs.

Text is programmed in a similar way to mobile phones. Select characters by pressing the corresponding key the appropriate number of times (to select a character on the same key, press to move the cursor along).

Custom O/P Text

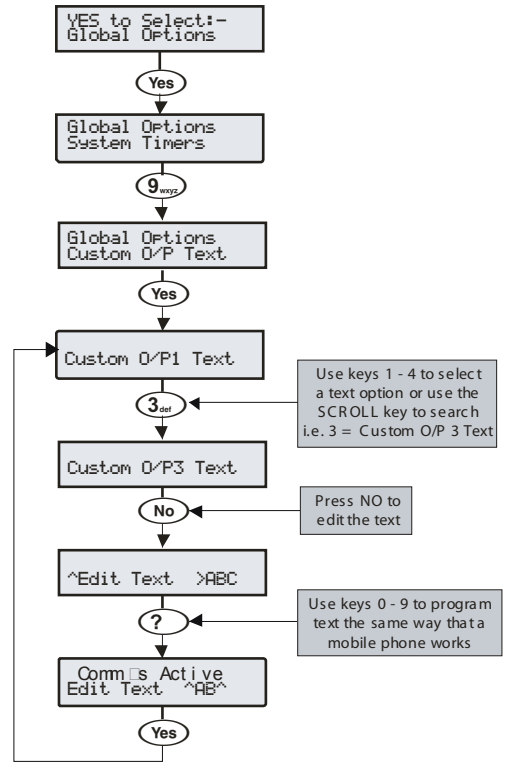

Text may be assigned to Custom Outputs 1 to 4 to allow indication on the keypads display when the output is active (see page 82 for details).



Outputs 1 & 2 are silent and outputs 3 & 4 give an audible warning every 30 seconds for 3 minutes or until a code is entered or RESET is pressed.

Text is programmed in a similar way to mobile phones. Select characters by pressing the corresponding key the appropriate number of times (to select a character on the same key, press to move the cursor along).

5.4 Keypad Setup

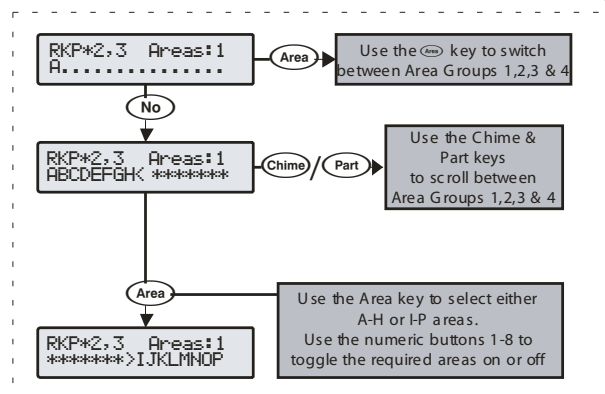
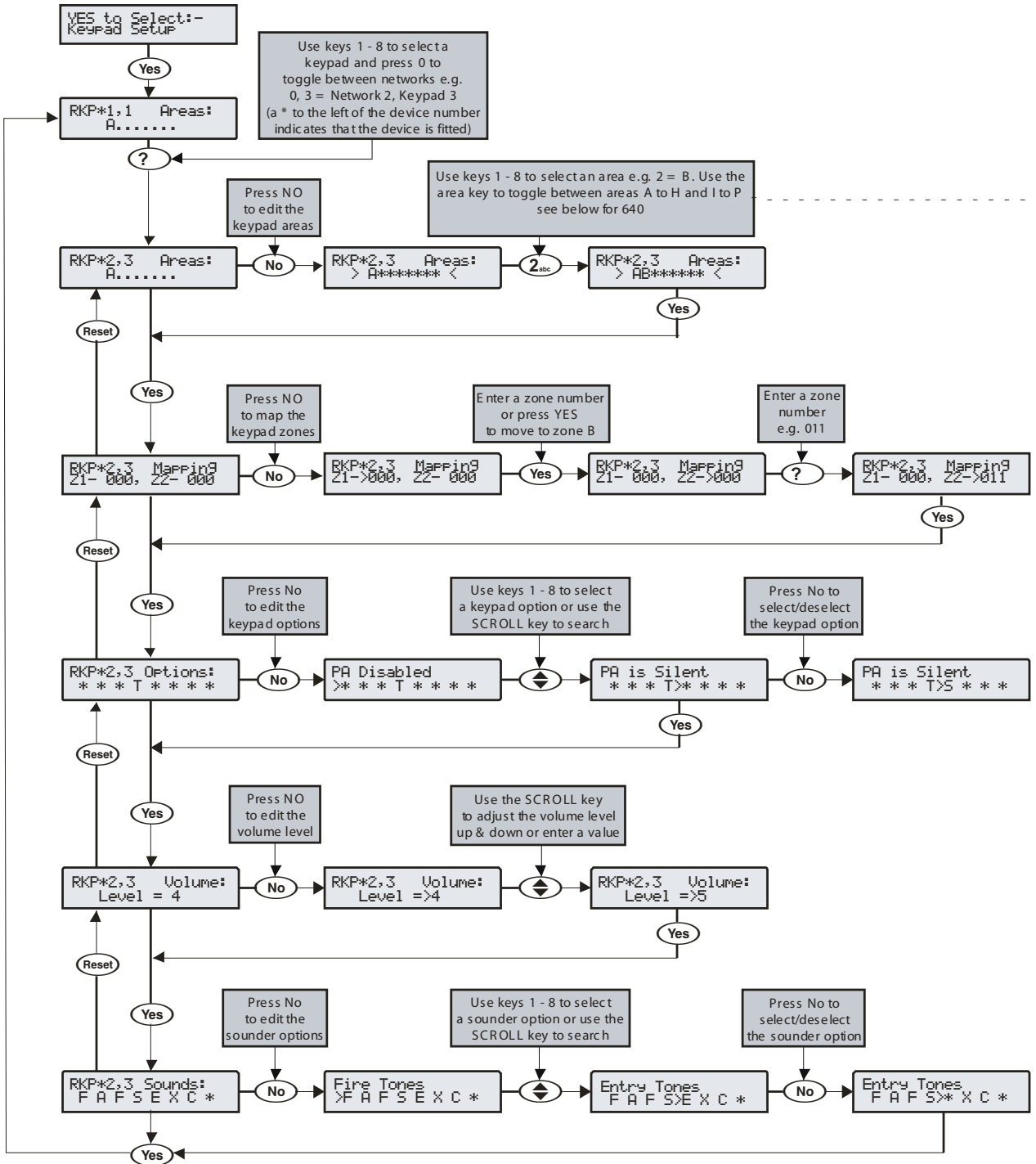

Keypad Areas

Keypads can be assigned to any number of areas, assigning a keypad to an area determines:

- Which areas the sounder and speaker output in the keypad will generate tones for i.e. if the keypad is assigned to areas A and C, the sounder/speaker will only operate when areas A or C are in alarm, entry, exit etc.
- Which areas can be armed or disarmed from that keypad when using codes that have the 'Local Arming' or 'Local Disarming' attributes (see page 110 for details)
- Which areas will cause a Tamper alarm when the keypad cover is removed

Keypad Zone Mapping

The zones in the keypad need to be mapped to a valid zone number before they can be used as part of the system i.e. Keypad 1 Zone 1 could be mapped to Zone 5 (panel) and Zone 2 could be mapped to Zone 25 (expander 3) etc.



Until mapped, the zones in the keypads will not work.

A keypad zone can be mapped to any zone number on the system, however, when mapped to a zone number that already exists i.e. Zone 5 (panel), that zone can no longer be used.

If a zone is mapped to a zone number not already on the system i.e. Zone 25 (expander 3) and expander 3 is then added, that zone on the expander (Zone 25) cannot be used. If you wish to use the zone on the expander, the keypad zone must be remapped to a different number.

If a zone is remapped to a different number, the new zone number must be treated as a new zone on the system and therefore needs to be programmed accordingly (the zone programming will NOT automatically follow the mapping).

Keypad Options

These 8 options control various keypad functions:

Select options by pressing keys 1 to 8 (a letter on the display means the option is selected, a Dot on the display means the option is not selected).

P - PA Enabled

Pressing keys 1 & 3 together will cause a PA alarm.

F - Fire Enabled

Pressing keys 4 & 6 together will cause a Fire alarm.

M - Medical Enabled

Pressing keys 7 & 9 together will cause a Medical alarm.

T - Tamper Enabled

Removing the keypad cover will cause a Tamper alarm.

A - PA is Audible

A keypad PA (1 & 3) will cause an audible PA alarm.

D - PA is Delayed

When the keypad PA buttons (1 & 3) are pressed, the 'Keypad PA Delay' timer starts, if a User code is entered before the timer expires, no PA alarm will occur. If a User code is not entered before the timer expires, a PA alarm will occur (see page 63 for details).

Q - Quick Arm is Enabled

Pressing the Area or Part keys will Arm or Part Arm the areas that the keypad is assigned to without the need to enter a User code first.

O - Info.LED> Output

The 'Info.' LED on the keypad comes on when the keypad output activates and goes off when the keypad output deactivates.

Keypad Speaker Volume

This option controls the volume level of advisory tones from loudspeakers connected to the keypads. Advisory tones consist of 'Entry/Exit' and 'Warning' type tones. 1 = minimum; 8 = maximum.



Alarm tones are always full volume.

Keypad Sounder Options

The sounder and speaker output in the keypad can be programmed so that certain types of tones are not generated. When deselected, Fire, Alarms, Fault, Service, Entry, Exit and Chime tones will not be heard.

Select tones by pressing keys 1 to 8 (a letter on the display means the tone is selected, a Dot on the display means the tone is not selected).

F - Fire Tones On

Fire alarm tones will be generated by the keypad sounder/speaker.

A - Alarm Tones On

Intruder alarm, Tamper alarm and PA alarm tones will be generated by the keypad sounder/speaker.

F - Fault Tones On

Fault tones will be generated by the keypad sounder/speaker.

S - Service Tone On

Service and Warning tones will be generated by the keypad sounder/speaker.

E - Entry Tones On

Entry tones will be generated by the keypad sounder/speaker.

X - Exit Tones On

Exit tones will be generated by the keypad sounder/speaker.

C - Chime Tones On

Chime 1, 2 and 3 tones will be generated by the keypad sounder/speaker.

K - Use Keypad Areas

When selected, the keypad sounder and arming control is determined by the area that the keypad is assigned to.

When deselected, the keypad becomes an 'Area Arm Suite' controller (see page 55 for details). This allows different combinations of areas to be armed or disarmed depending on which keypad is used and operates as follows:

- Keypad 1 = Area Arm Suite 1, Keypad 2 = Area Arm Suite 2, Keypad 3 = Area Arm Suite 3 etc.
- When a User code is entered at a keypad, one of the 'Area Arm Suites' is selected (depending on which keypad was used) and the areas contained within that suite arm using the arming mode for that suite, the keypad sounder will also follow the areas defined by the suite.

5.5 Expander Setup

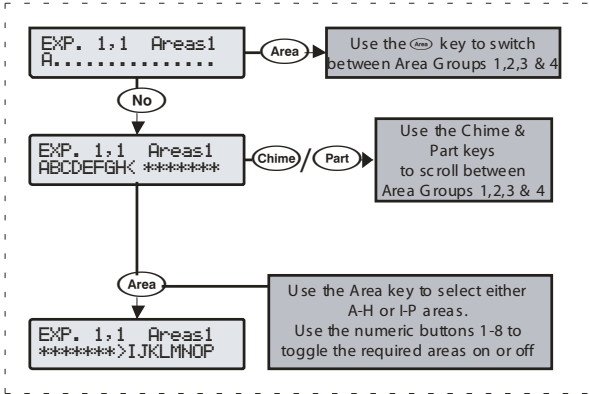
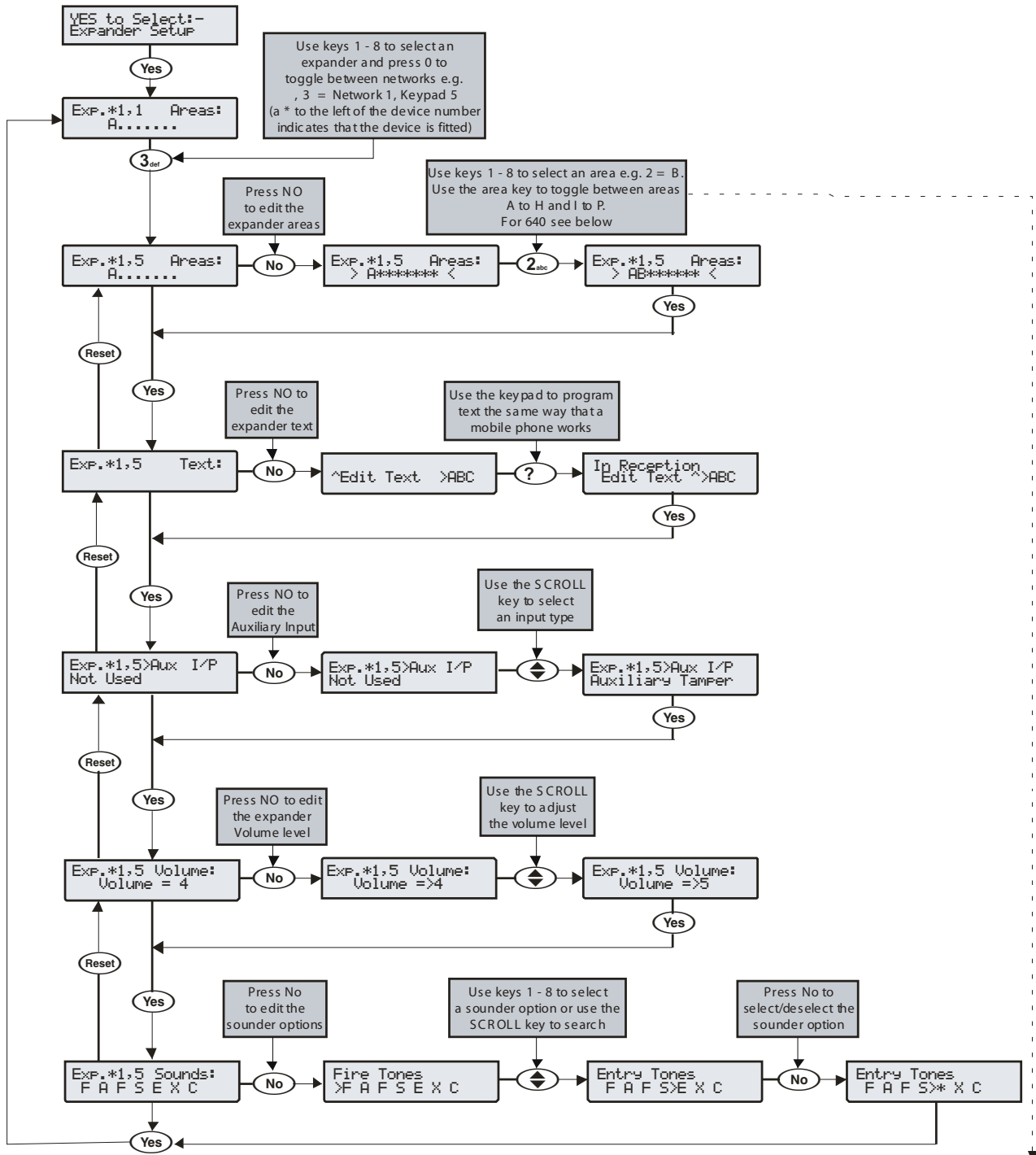

Expander Areas

Expanders can be assigned to any number of areas, assigning an expander to an area determines:

- Which areas the speaker output on the expander will generate tones for i.e. if the expander is assigned to areas A and C, the speaker will only operate when areas A or C are in alarm, entry, exit etc.
- Which areas will cause a Tamper alarm when the expander cover is removed

Expander Location Text

Each expander can be assigned up to 16 characters of text. This text can be used to describe where the expander is located within the building.

Text is programmed in a similar way to mobile phones. Select characters by pressing the corresponding key the appropriate number of times (to select a character on the same key, press the  key to move the cursor along).

Expander Auxiliary Input

Each expander has an input that can be programmed for one of the following options. If not being used, the input must be programmed as 'Not Used' (Default = Not Used).

Not Used

Never monitored by the system.

Auxiliary Tamper

Normally used for monitoring the box tamper of auxiliary devices such as power supplies etc (remove 0V for Tamper alarm).

Bell Tamper

Normally used for monitoring Bell Tamper returns (remove 0V for Tamper alarm).

Remote Reset

Normally used to reset the system/area following an Intruder alarm (the area must also be programmed for Anti-code reset) see page 58 for details (apply 0V to reset).

Line Fault +ve

Normally used to indicate a telephone line fault (remove 0V for Line Fault).

Line Fault -ve

Normally used to indicate a telephone line fault (apply 0V for Line Fault).

Silence Sounders

Normally used to silence the Internal sounders following an Intruder alarm and would be used in conjunction with Audio Verification units (apply 0V to silence).

Global Omit Key

Normally wired to a key switch. When the key switch is activated, all zones (with the 'Omit' attribute) assigned to the same area as the expander, will be omitted (0V removed for omit).

Local Omit Key

Normally wired to a key switch. When the key switch is activated, all zones (with the 'Omit' attribute) wired to the expander, will be omitted (0V removed for omit).

PSU Monitor

Normally used to monitor a Power Supply for faults, see page 35 for wiring details.

Defer Auto Arming

Normally used to defer the automatic arming of an area (apply 0V to defer).

Expander Speaker Volume

This option controls the volume level of advisory tones from loudspeakers connected to the expanders. Advisory tones consist of 'Entry/Exit' and 'Warning' type tones. 1 = minimum; 8 = maximum.



Alarm tones are always full volume.

Expander Sounder Options

The speaker output on the expander can be programmed so that certain types of tones are not generated. When deselected, Fire, Alarms, Fault, Service, Entry, Exit and Chime tones will not be heard.

Select tones by pressing keys 1 to 8 (a letter on the display means the tone is selected, a Dot on the display means the tone is not selected).

F - Fire Tones On

Fire alarm tones will be generated by the expander sounder/speaker.

A - Alarm Tones On

Intruder alarm, Tamper alarm and PA alarm tones will be generated by the expander speaker.

F - Fault Tones On

Fault tones will be generated by the expander speaker.

S - Service Tone On

Service and Warning tones will be generated by the expander speaker.

E - Entry Tones On

Entry tones will be generated by the expander speaker.

X - Exit Tones On

Exit tones will be generated by the expander speaker.

C - Chime Tones On

Chime 1, 2 and 3 tones will be generated by the expander speaker.

5.6 System Outputs

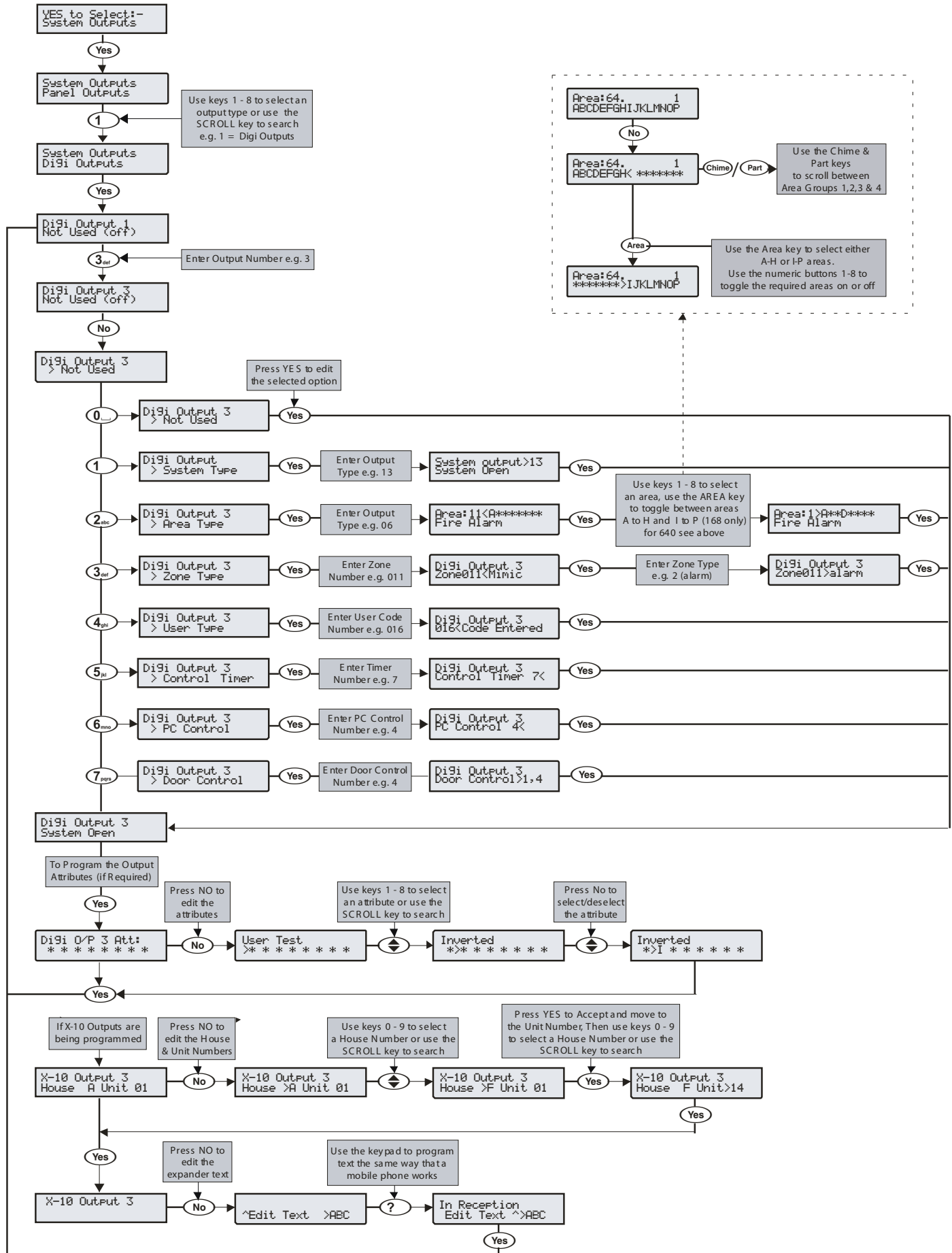

Available Outputs

Various sets of programmable outputs can be found on the control panel, keypads, expanders and output modules.

Panel Outputs

Panel outputs 1 - 5 are located on the top right hand corner of the control panel and can be programmed to any of the output types listed (see page 34 for wiring details).

Digi Outputs

Digi outputs 1 - 8 are located on the left hand side of the control panel and can be programmed to any of the output types listed (see page 34 for wiring details).

Digi Channels

Digi channels 1 - 8 are for the *Com300* and *Com2400* plug-on communicators and can be programmed to any of the output types listed.

RedCARE/Relay Pins

RedCARE or Relay Pins 1 - 8 are for a plug on RedCARE or *RM8* Relay module and can be programmed to any of the output types listed.

Keypad Outputs

Keypad outputs are for the outputs on the remote keypads (see page 22 for details) and can be programmed to any of the output types listed. Wire as per Panel Outputs shown on page 34.

Expander Outputs

Expander outputs are for the outputs on the zone/output expanders (see page 23 for details) and can be programmed to any of the output types listed. Wire as per Panel Outputs shown on page 34.

Custom Outputs

Custom outputs are NOT physical outputs they are 'Software' outputs that can be configured to operate under certain conditions (see page 81 for details). Once configured these outputs can then be assigned to a physical output (see system outputs 22-27).

X-10 Outputs

X-10 outputs are NOT physical outputs they are 'Software' outputs that can be configured to operate devices that are connected to an X-10 controller. These outputs can also be assigned a house and unit number along with descriptive text. (see page 81 for details).

Programming Outputs

When programming outputs, select an output group and an output type from that group's list (each output group has its own output types) then select attributes (if required).



NOTE *Output Group + Output Type + Output Attributes = Output Programmed.*

Output Group - Not Used

Only the following output type is available:

Not Used (off)

This output type never activates.

Output Group - System

Select an output type from the following options:

00 - ATS Path Fault

This output type activates when a fault is detected with the Alarm Transmission System and deactivates when the fault is cleared.

01 - Mains Power Off

This output type activates when no AC Mains is detected on the control panel and deactivates when mains is detected.

02 - Aux Fuse Blown

This output type activates when the Auxiliary fuse (F1) fails and deactivates when the system is reset.

03 - Bell Tamper

This output type activates when the control panel Bell tamper or an expander input (programmed as Bell tamper) is activated, causing a Tamper alarm on the system, and deactivates when the Tamper alarm is reset.

04 - Auxiliary Tamper

This output type activates when the control panel Aux tamper or an expander input (programmed as Auxiliary tamper) is activated, causing a Tamper alarm on the system, and deactivates when the Tamper alarm is reset.

05 - Panel Lid Tamper

This output type activates whenever the panel cover is removed, causing a Tamper alarm on the system, and deactivates when the Tamper alarm is reset.

06 - Engineer Working

This output type activates whenever an Engineer code is entered to access the programming menu and deactivates when the engineer logs off.

07 - Confirm Devices

This output type activates when the control panel requires devices to be confirmed and deactivates when the devices are confirmed (see page 117 for details).

08 - Service Required

This output type activates when the 'Service Interval' timer expires and deactivates when an Engineer code is entered (see page 62 for details).

09 - Bell Fuse Blown

This output type activates when the control panel bell fuse (F4) fails and deactivates when the system is reset.

10 - Battery Fault

This output type activates when the system detects a fault with the stand-by battery, and deactivates when the fault clears.

11 - Battery Test On

This output type activates when the 'Battery Test' starts, and deactivates when the test expires (see page 62 for details).

12 - Courtesy Light

This output type activates when the 'Courtesy' timer starts, and deactivates when the timer expires (see page 62 for details).

13 - System Open

This output type activates when all areas are unarmed, and deactivates when any area is armed.

14 - Fully Arm

This output type activates when the system is fully armed and deactivates when the system is disarmed.

15 - Digi Failed

This output type activates when the plug-on communicator fails to report to the Alarm Receiving Centre (after 3 dialling attempts), and deactivates the next time the communicator successfully reports to the Alarm Receiving Centre.

16 - Digi Successful

This output type activates when the plug-on communicator successfully reports to the Alarm Receiving Centre and deactivates the next time the communicator is triggered.

17 - Digi Active

This output type activates when the plug-on communicator is triggered and deactivates when the communicator shuts down.

18 - UDL Lockout

This output type activates when an attempt is made to upload/download with incorrect site details more than three times and deactivates after 4 hours or after a valid User code is entered.

19 - UDL Call Active

This output type activates when an upload/download is started and deactivates when the upload/download finishes.

20 - UDL Enabled

This output type activates when 'Enable UDL/Engineer' is enabled and deactivates when 'Enable UDL/Engineer' is disabled (see page 110 for details).

21 - Confirmed Alarm

If the system is already in alarm, this output type activates when a different zone (not on the entry route) is activated and deactivates at the end of the 'Confirmation' time, when a code is entered within the 'Abort' time or when the alarm is reset.

22 - Custom1 Stage A

This output type operates when 'Custom Output 1' Stage A activates and deactivates when 'Custom Output 1' Stage A deactivates.

23 - Custom1 Stage B

This output type operates when 'Custom Output 1' Stage B activates and deactivates when 'Custom Output 1' Stage B deactivates.

24 - Custom1 Stage AB

This output type operates when 'Custom Output 1' Stage A or B activates and deactivates when 'Custom Output 1' Stage A deactivates.

25 - Custom2 Stage A

This output type operates when 'Custom Output 2' Stage A activates and deactivates when 'Custom Output 2' Stage A deactivates.

26 - Custom2 Stage B

This output type operates when 'Custom Output 2' Stage B activates and deactivates when 'Custom Output 2' Stage B deactivates.

27 - Custom2 Stage AB

This output type operates when 'Custom Output 2' Stage A or B activates and deactivates when 'Custom Output 2' Stage A deactivates.

28 - Radio-Pad Failed

This output type activates when the radio pad fails to communicate with the Alarm Receiving Centre and deactivates when the radio pad successfully communicates.

29 - Radio Successful

This output type activates when the radio pad successfully communicates with the Alarm Receiving Centre and deactivates when the radio pad fails to successfully communicate.

30 - No Radio Signal

This output type activates when the Radio-Pads forward signal is lost and deactivates when the signal is regained.

31 - Radio-Pad Lost

This output type activates when the Radio-Pad stops communicating with its base station or the control panel and deactivates when communication starts again.

32 - Custom3 Stage A

This output type operates when 'Custom Output 3' Stage A activates and deactivates when 'Custom Output 3' Stage A deactivates.

33 - Custom3 Stage B

This output type operates when 'Custom Output 3' Stage B activates and deactivates when 'Custom Output 3' Stage B deactivates.

34 - Custom3 Stage AB

This output type operates when 'Custom Output 3' Stage A or B activates and deactivates when 'Custom Output 3' Stage A deactivates.

35 - Custom4 Stage A

This output type operates when 'Custom Output 4' Stage A activates and deactivates when 'Custom Output 4' Stage A deactivates.

36 - Custom4 Stage B

This output type operates when 'Custom Output 4' Stage B activates and deactivates when 'Custom Output 4' Stage B deactivates.

37 - Custom4 Stage AB

This output type operates when 'Custom Output 4' Stage A or B activates and deactivates when 'Custom Output 4' Stage A deactivates.

38 - Com 1 Fault

This output type activates when whatever is connected to Com Port 1 stops communicating with the control panel and deactivates when communication starts again.

39 - Com 2 Fault

This output type activates when whatever is connected to Com Port 2 stops communicating with the control panel and deactivates when communication starts again.

40 - Com 3 Fault

This output type activates when whatever is connected to Com Port 3 stops communicating with the control panel and deactivates when communication starts again.

41 - Com 1 No Signal

This output type activates when whatever is connected to Com Port 1 loses its signal and deactivates when its signal is regained.

42 - Com 2 No Signal

This output type activates when whatever is connected to Com Port 2 loses its signal and deactivates when its signal is regained.

43 - Com 3 No Signal

This output type activates when whatever is connected to Com Port 3 loses its signal and deactivates when its signal is regained.

44 - Coms Fault

This output type activates whenever any type of communication fault occurs i.e. No Signal, Com Port Fault, line fault etc. and deactivates when communication starts again.

45 - Radio Jamming

This output type activates whenever the wireless radio receiver detects a jamming signal and deactivates when the jamming signal is removed.

46 - Radio RX Tamper

This output type activates when the wireless radio receiver lid is removed, causing a Tamper alarm on the system, and deactivates when the Tamper alarm is reset.

47 - Detector Test

This output type is activated via Wintex to initiate a diagnostics check on an PD6662: 2004/EN 50131-1 Grade 3 detector and deactivates after 10 seconds.

48 - ATS Remote Test

This output type conforms to the BSIA Form 175 Specification. When a Line Fault is not present it can be activated remotely by Wintex, or by using the 'Test Call Timer' or 'Start Test Call' option on the control panel to initiate a test on ATE equipment that have an ATS test input. NOTE: Only the RedCare Line Fault and Control panel Line Fault inputs can be used with the output type.

49 - No ATS Available

This output type activates when no Alarm Transmission paths are available and deactivates when the fault is cleared.

50 - CIE Fault

This output type activates when a fault occurs on the CIE and deactivates when the fault is cleared.

51 - PSU Fuse Blown

This output type activates when the Auxiliary input type 'PSU Monitor' detects a 12V failure and deactivates when the fault is reset.

52 - PSU Battery Flt

This output type activates when the Auxiliary input type 'PSU Monitor' detects a battery fault and deactivates when the fault is reset.

53 - WD Test Active

This output is activated via remote maintenance software to initiate a diagnostics check on an external sounder with remote test capability and will deactivate after 1 minute.

Output Group - Area

Any number of areas can be assigned to each output type. Select an output type from the following options:

00 - Alarm

This output type activates when any type of Intruder alarm occurs in the selected area, and deactivates when the Intruder alarm is reset.

01 - Guard Alarm

This output type activates when a zone programmed as 'Guard' causes an Intruder alarm in the selected area and deactivates when the alarm is reset.

02 - Guard Access Alarm

This output type activates when a zone programmed as 'Guard Access' causes an Intruder alarm in the selected area and deactivates when the alarm is reset.

03 - Entry Alarm

This output type activates when a zone programmed as 'Entry/Exit 1 or 2' causes an Intruder alarm in the selected area and deactivates when the alarm is reset.

04 - Confirmed Alarm

If an area is already in alarm, this output type activates when a different zone (not on the entry route) is activated in the selected area and deactivates at the end of the 'Confirmation' time, when a code is entered within the 'Abort' time or when the alarm is reset.

05 - 24Hr Audible

This output type activates when a zone programmed as '24Hr Audible' causes an Internal alarm or Intruder alarm in the selected area and deactivates when the alarm is reset.

06 - 24Hr Silent

This output type activates when a zone programmed as '24Hr Silent' causes a silent alarm or Intruder alarm in the selected area and deactivates when the alarm is reset.

07 - 24Hr Gas

This output type activates when a zone programmed as '24Hr Gas' causes a Silent alarm or Intruder alarm in the selected area and deactivates when the alarm is reset.

08 - PA Alarm

This output type activates when any type of 'PA alarm' i.e. PA audible, PA silent or Duress causes a PA alarm in the selected area and deactivates when the alarm is reset.

09 - PA Silent

This output type activates when a zone programmed as 'PA Silent' or a keypad PA (1 & 3) causes a silent PA alarm in the selected area and deactivates when the alarm is reset.

10 - Duress

This output type activates when a User code with the 'Duress' attribute causes a silent PA alarm in the selected area and deactivates when the alarm is reset.

11 - Fire Alarm

This output type activates when a zone programmed as 'Fire' or a keypad Fire (4 & 6) causes a Fire alarm in the selected area and deactivates when the alarm is reset.

12 - Medical

This output type activates when a zone programmed as 'Medical' or a keypad Medical (7 & 9) causes a Medical alarm in the selected area and deactivates when the alarm is reset.

13 - Auxiliary Alarm

This output type activates when a zone programmed as 'Auxiliary' causes a Silent alarm in the selected area and deactivates when the alarm is reset.

14 - Tamper Alarm

This output type activates when any type of Tamper alarm occurs in the selected area and deactivates when the alarm is reset.

15 - Alarm Abort

If the selected area is in alarm, this output type activates when a User code is entered to cancel the alarm in the selected area and deactivates after 10 seconds.

16 - Ready

This output type activates when all zones in the selected area are secure and deactivates when any zone in the selected area is activated.

17 - Entry Mode

This output type activates when the selected area is in the entry mode and deactivates when the area is not in the entry mode.

18 - 2nd Entry Mode

This output type activates when the 2nd entry timer for the selected area starts and deactivates when the 2nd entry timer expires.

19 - Exit Mode

This output type activates when the selected area is in the exit mode and deactivates when the area is not in the exit mode.

20 - Entry/Exit Mode

This output type activates when the selected area is in the entry or exit mode and deactivates when the area is no longer in the entry or exit mode.

21 - Armed

This output type activates when the selected area is armed and deactivates when the selected area is disarmed.

22 - Full Armed

This output type activates when the selected area is fully armed and deactivates when the selected area is disarmed.

23 - Part Armed

This output type activates when the selected area is part armed and deactivates when the selected area is disarmed.

24 - Part Arming

This output type activates when the selected area is part arming and deactivates when the selected area arms.

25 - Force Armable

This output type activates when the selected area has at least one zone with the 'Force Omit' attribute, and the area is able to be force armed. It will deactivate when the area cannot be force armed.

26 - Force Armed

This output type activates when the selected area is forced to arm with zones active, and deactivates when all zones are reinstated.

27 - Arm Failed

This output type activates when the selected area fails to arm because a zone is in fault, and deactivates when a valid User code is entered.

28 - Bell SAB

This output type activates when an External alarm occurs in the selected area, and deactivates when area is disarmed or the 'Bell Duration' timer expires.

29 - Bell SCB

This output type deactivates when an External alarm occurs in the selected area, and activates when area is disarmed or the 'Bell Duration' timer expires.

30 - Strobe

This output type activates when an External alarm (or Arm Fail) occurs in the selected area, and deactivates when area is disarmed (or a valid User code is entered).

31 - Detector Latch

This output type activates for 5 seconds when the selected area is in the exit mode then activates again when the area arms and deactivates when an Intruder alarm occurs or the selected area is disarmed.

32 - Detector Reset

This output type is normally active, and deactivates for 5 seconds when the selected area is in the exit mode.

33 - Walk Test Active

This output type activates when the 'Walk Test' procedure is selected, and deactivates when the 'Walk Test' procedure is cancelled.

34 - Zones Omitted

This output type activates when a zone in the selected area with the 'Omit' attribute, is omitted by the user, and deactivates when the zone is reinstated.

35 - 24Hr Zones Omit

This output type activates when a zone programmed as '24Hr Audible' or '24Hr Silent' (with the 'Omit' attribute) is omitted by the user, and deactivates when the zone is reinstated.

36 - Reset Required

This output type activates when the selected area requires a reset following an alarm, and deactivates when the alarm is reset.

37 - Door Strike

This output type activates for the 4 seconds when a User code with the 'Door Strike' attribute is entered for the selected area.

38 - Chime Mimic

This output type activates for 2 seconds when a zone in the selected area with the 'Chime' attribute is activated.

39 - Chime Enabled

This output type activates when 'Chime' is enabled for the selected area, and deactivates when 'Chime' is disabled for the selected area.

40 - DK First Knock

This output type activates when a zone in the selected area with the 'Double Knock' attribute is activated for the first time, and deactivates when the zone causes an alarm or the 'Double Knock Delay' timer expires.

41 - BP First Knock

This output type activates when a zone in the selected area with the 'Beam Pair' attribute is activated for the first time and deactivates when another zone with the 'Beam Pair' attribute, causes an alarm or the 'Beam Pair Time' expires.

42 - On Test

This output type activates when a zone in the selected area with the 'Test' attribute is placed on test and deactivates when the 'Soak Test Time' expires.

43 - Test Fail

This output type activates when a zone in the selected area with the 'Test' attribute is placed on test (and fails) and deactivates when an Engineer code is entered or the 'Soak Test Time' expires.

44 - Internal Alarm

This output type activates when an Internal alarm occurs in the selected area, and deactivates when the alarm is cancelled.

45 - Auto Arming

This output type activates when the selected area 'Auto Arms', and deactivates when the selected area is disarmed.

46 - Time Arming

This output type activates for 5 minutes prior to the selected area being armed using the 'Control Timers'.

47 - 1st Code Entered

This output type activates for 30 seconds when a User code with the 'Dual Code' attribute is entered for the selected area.

48 - 2nd Code Entered

This output type activates for 30 seconds when two User codes with the 'Dual Code' attribute are entered for the selected area.

49 - Area Secured

This output type activates whenever a 'Security Key' zone type is used to lock keypads out and deactivates when the keypads are unlocked again.

50 - Part Armed 1

This output type activates when a Part Arm 1 is selected for the selected area and deactivates when part arm 1 is disarmed.

51 - Part Armed 2

This output type activates when a Part Arm 2 is selected for the selected area and deactivates when part arm 2 is disarmed.

52 - Part Armed 3

This output type activates when a Part Arm 3 is selected for the selected area and deactivates when part arm 3 is disarmed.

53 - Custom Alarm

This output type activates when any 'Custom' zone type causes an alarm in the selected area and deactivates when a valid user code is entered.

54 - Zone Warning

This output type activates when 'Custom' zone type in the selected area with the 'Warning Req' attribute (see page 52 for details) is activated for the duration of the 'Warning Delay' timer (see page 63 for details) and deactivates when the zone activity is cleared.

55 - Arm Fail Warning

This output type activates when the selected area fails to arm after a period of time (controlled by the area exit time) when using 'Entry/Exit' or 'Exit Term.' arming and deactivates when the area arms.

56 - Forced Entry

This output type activates for the duration of the 'Forced Entry' timer (see page 63 for details) when any 'Guard' or 'Custom' zone with the 'Guard' attribute is activated (see page 51 for details).

57 - Zones Locked Out

This output type activates when any zone is locked out following an Intruder Alarm activation and deactivates when all zones are clear and reinstated.

58 - All Areas Armed

This output type activates when all of the selected areas are armed and deactivates when any one of those areas is disarmed.

59 - Time Arm Disabled

This output type activates when the timed arming procedure is disabled (see page 52 for details) and deactivates when timed arming is reinstated.

60 - Armed/Alarm

This output type activates when the selected area is armed and deactivates when the selected area is disarmed

This output type also pulses when an Intruder alarm occurs in the selected area, and deactivates when the selected area is disarmed.

61 - Intruder Alarm

This output type activates when an Intruder alarm occurs, and deactivates when the Intruder alarm is cancelled.



NOTE Tamper alarms will not activate this output

62 - Speaker Mimic

This output type activates whenever the internal speaker output is on, and deactivates when the speaker output is off.

63 - Full Armed/Exit

This output type activates when the selected area is in the full arm exit mode and then arms and deactivates when the area is disarmed.

64 - Detector Fault

This output type activates when a detector fault occurs and deactivates when the fault is reset.

65 - Detector Masked

This output type activates when a detector mask occurs and deactivates when the mask is reset.

66 - Fault Present

This output type activates when a general fault occurs i.e. Line Fault, AC Mains Fail, Detector Fault etc. and deactivates when the fault is cleared.

67 - LED Control

This output type is always activate and deactivates when a User or Engineers code is entered to gain access to a menu. The output activates again 30 seconds after the user/engineer exits the menu. This output type is for use with detectors that require 0V applied to disable their LED's.

68 - Full Arm Entry

This output type activates when the entry mode is started and deactivates when the entry mode finishes whenever the system in Full Armed.

69 - Fire Sounder

This output type activates when a Zone programmed as 'Fire', or a Keypad Fire (4&6) causes a Fire Alarm in the selected area and deactivates when the alarm is reset.

70 – Confirmed PA

If an area is in PA alarm this output type activates when one of the following happens.



NOTE another PA zone is activated



NOTE A tamper is detected from a different device



NOTE A second signal from a multi action PA



NOTE A global tamper within the timer period

71 – Confirmed Intruder

If an area is in Alarm, this output type activates when a different zone (not the entry route) is activated in the same area. This output type deactivates at the end of the 'confirmation time' when a valid code is entered within the Abort time, or when the alarm is reset.

Output Group - Zone

Any zone can be assigned to this output type. Select a zone number then select an output type from the following options:

Mimic

This output type activates when the selected zone is activated and deactivates when the zone is secure. This output will work if the zone is armed or disarmed.

MimicArm

This output type activates when the selected zone is activated and deactivates when the zone is secured. This output will only work if the zone is armed.

Alarm

This output type activates when the selected zone causes an alarm and deactivates when the alarm is reset. This output will only work if the zone is armed.

Tamper

This output type activates when the selected zone causes a Tamper alarm and deactivates when the tamper is reset. This output will work if the zone is armed or disarmed.

MimicLat

This output type activates when the selected zone is activated and deactivates when the next time the zone is activated. This output will work if the zone is armed or disarmed.

Omitted

This output type activates when the selected zone is omitted and deactivates when the zone is reinstated.

Output Group - User Code Entered

Any user can be assigned to this output type.

This output type activates for 5 seconds when the selected User code is entered.

Output Group - Control Timer

Select a Control Timer.

These output types activate when the respective control timer turns on and deactivate when the timer turns off.

Output Group - PC Control

Select a PC Control.

These output types can be activated and deactivated using a PC running the *Wintex UDL* software.

Output Group - Door Control

Select a Door Control from 1,1 to 1,4 (48), 1,1 to 1,8 (88), 1,1 to 2,8 (168), 1,1 to 8-8 (640).

These output types activate for the duration of the 'Door Strike' timer when a valid User code (assigned to the same door) is entered and deactivates when the timer expires.

These output types are used in conjunction with the 'Door Control' User option (see page 111 for details).

Output Attributes

Assigning an attribute to an output will alter how the output works. The following attributes can be assigned to any of the various types listed.

Select attributes by pressing keys 1 to 8 (a letter on the display means the attribute is selected, a 'Dot' on the display means the attribute is not selected).

U - User Test

The output will activate when a user performs a User test (see page 117 for details).

I - Inverted

The output is inverted (an output that applies 0V when active will become an output that applies 12V when active).

L - Latching

When activated, the output will remain on until a valid User code is entered.

1 - Use Pulse Period 1

When activated, the output will remain on for the duration of the 'Pulse Period 1' timer (see page 62 for details).

2 - Use Pulse Period 2

When activated, the output will remain on for the duration of the 'Pulse Period 2' timer (see page 62 for details).

3 - Use Pulse Period 3

When activated, the output will remain on for the duration of the 'Pulse Period 3' timer (see page 62 for details).

C - Only Active With Custom Output 1 Stage A

The output will only operate whilst 'Custom Output Stage A' is 'On' (see page 'Custom Outputs' for details).

R - Random

The output will activate randomly. A minimum and maximum 'On' time can also be programmed (see page 62 for details).

X-10 Outputs

X-10 Outputs are outputs that can be configured to operate devices that are connected to an X-10 controller. These outputs can be assigned a house and unit number.

To Program an output for X-10, proceed as follows:

Program the output type to ensure correct operation when the programmed condition occurs i.e. an output programmed as 'Entry/Exit' will activate when the selected area is in the entry or exit mode and deactivate when the area is no longer in the entry or exit mode.

Assign any attributes i.e. 'Pulsed 1' would cause the output to be timed for the duration of the 'Pulse 1' timer.

Assign a House and Unit number i.e. this is the physical address of the X-10 Unit and ensures that the correct unit in the correct area operates when the output condition is met i.e. the correct unit switches on and off during Entry/Exit.

Custom Outputs

Custom outputs are NOT physical outputs they are 'Software outputs that can be configured to operate under certain conditions. Once configured these outputs can then be assigned to a physical output (see system outputs 22-27 and 32-37, page 78 for details).

Custom Output 1 - 4, Stage A

Will activate when switches 1 or 2 and 3 and 4 are active.

Custom Output 1 - 4, Stage B

Will activate when switches 5 or 6 and 7 and 8 are active.

Custom Output 1 - 4, Stage AB

Will activate when switches 1 or 2 and 3 and 4 are active **OR** switches 5 or 6 and 7 and 8 are active.

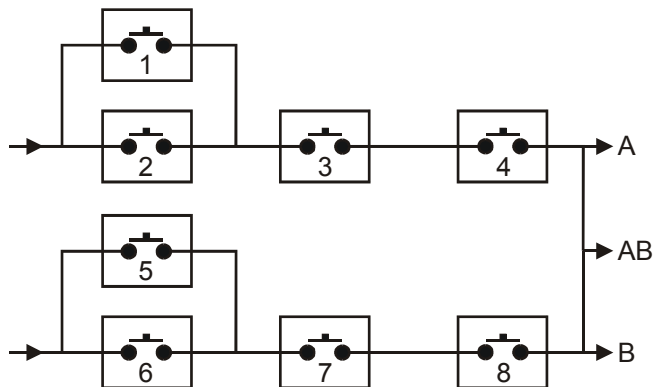

Example

Switch 1 is programmed as: **Zone 1 Mimic**

Switch 2 is programmed as: **Zone 2 Mimic**

Switch 3 is programmed as: **Armed**

Switch 4 is programmed as: **Never Active (and inverted)**



Custom Output 1 Stage A will only activate when switches 1 OR 2 AND 3 AND 4 are closed.

i.e. if ZONE 1 or ZONE 2 ACTIVATES whilst the system is ARMED (switch 4 is always closed).

Assign up to 16 Characters of text to each unit to allow easy identification when the output needs to be manually triggered directly from the keypad using the **Menu** **9** command i.e. 'Entrance Light'.

Zone Group Outputs

Zone Group Outputs will activate when one or more zones on the control panel are assigned to a Zone Group.

Zone Group Mimic

This output type will become active when a zone assigned to the group goes active or changes state.

Zone Group Armed

This output type will become active when a zone assigned to the group goes active when the area the zones is assigned too is armed.

5.7 UDL/Digi Options

Reset Digi

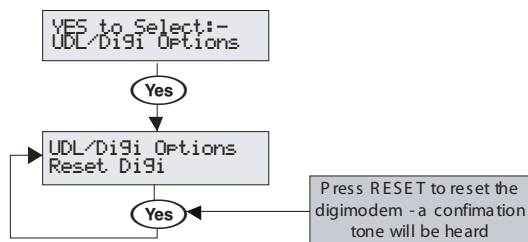

This option should be used whenever a plug-on communicator is plugged on or removed from the control panel.

Start Test Call

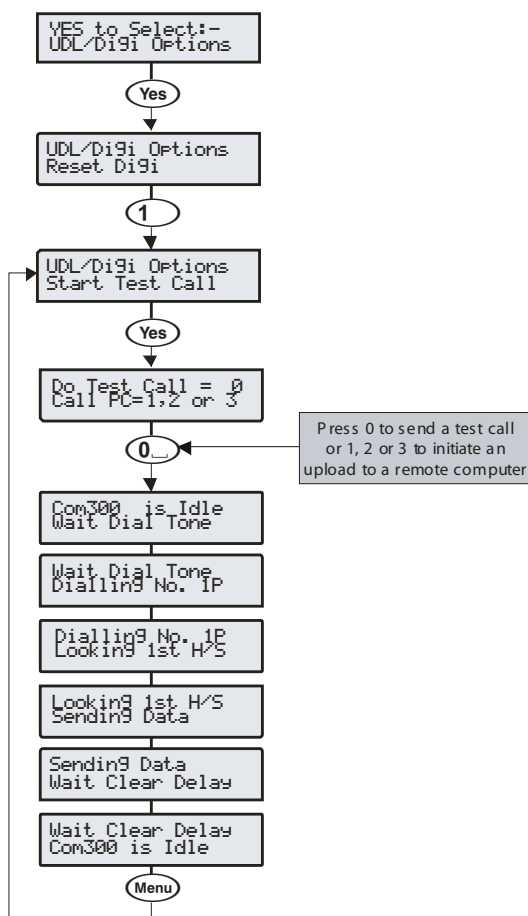

When a plug-on communicator has been fitted to the control panel. This option can be used to send a test call to the Alarm Receiving Centre or to initiate a remote Upload/Download call to one of the programmed call-back numbers.

MSN/Pre-Dial No.

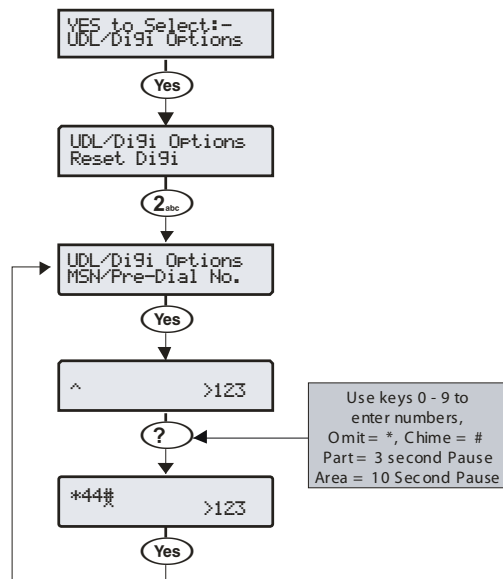

When a ComISDN is connected to an extension of an ISDN line with more than 1 number, the direct dial number should be programmed in here, this ensures that the ComISDN will only answer a call when the direct dial number is dialled. This number can be up to 24 digits.

NOTE The Use MSN/Pre-Dial option must also be enabled (see page 88 for details).

When entering the telephone number the following extra keys can be used:

Program Digi

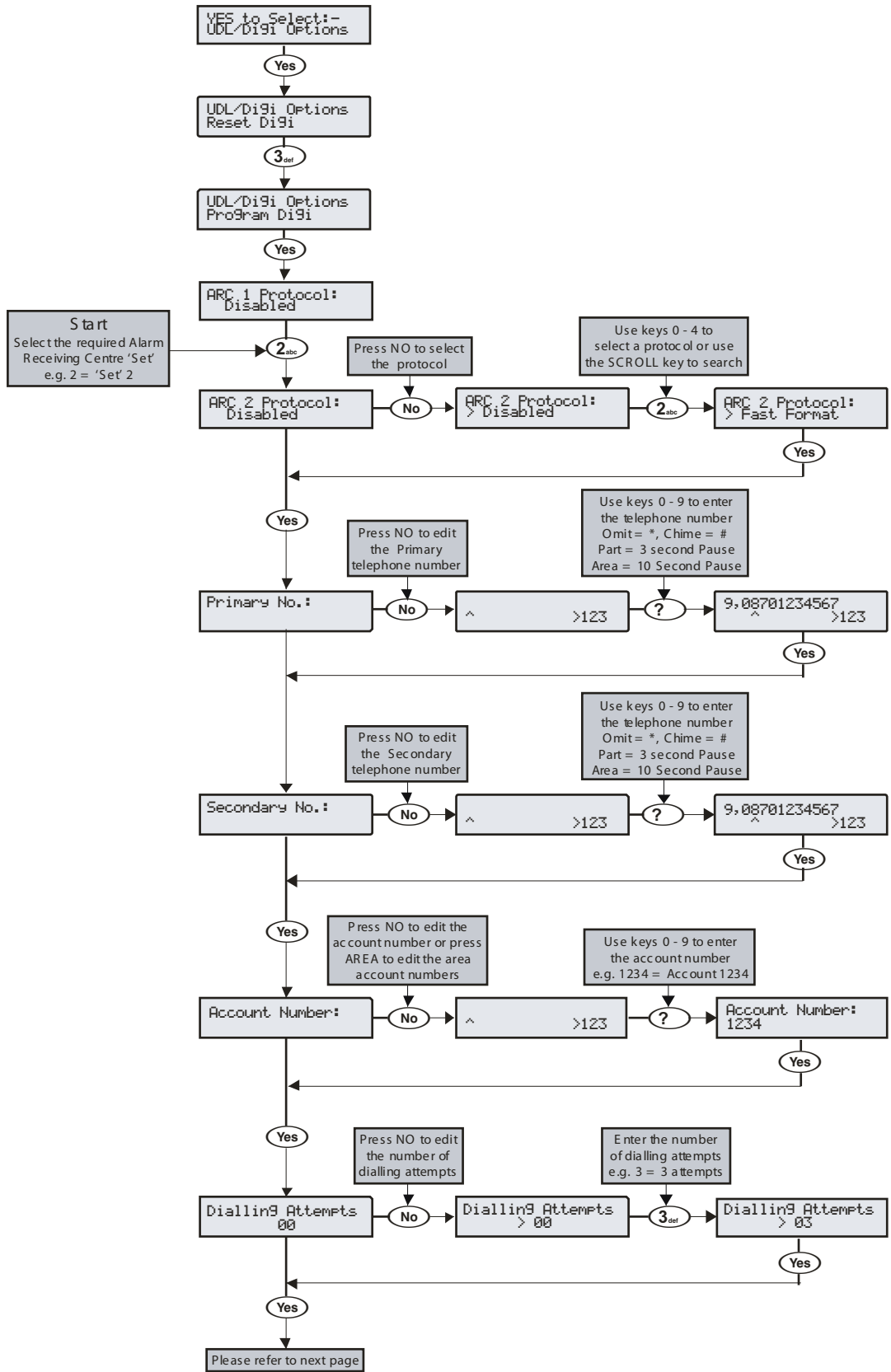

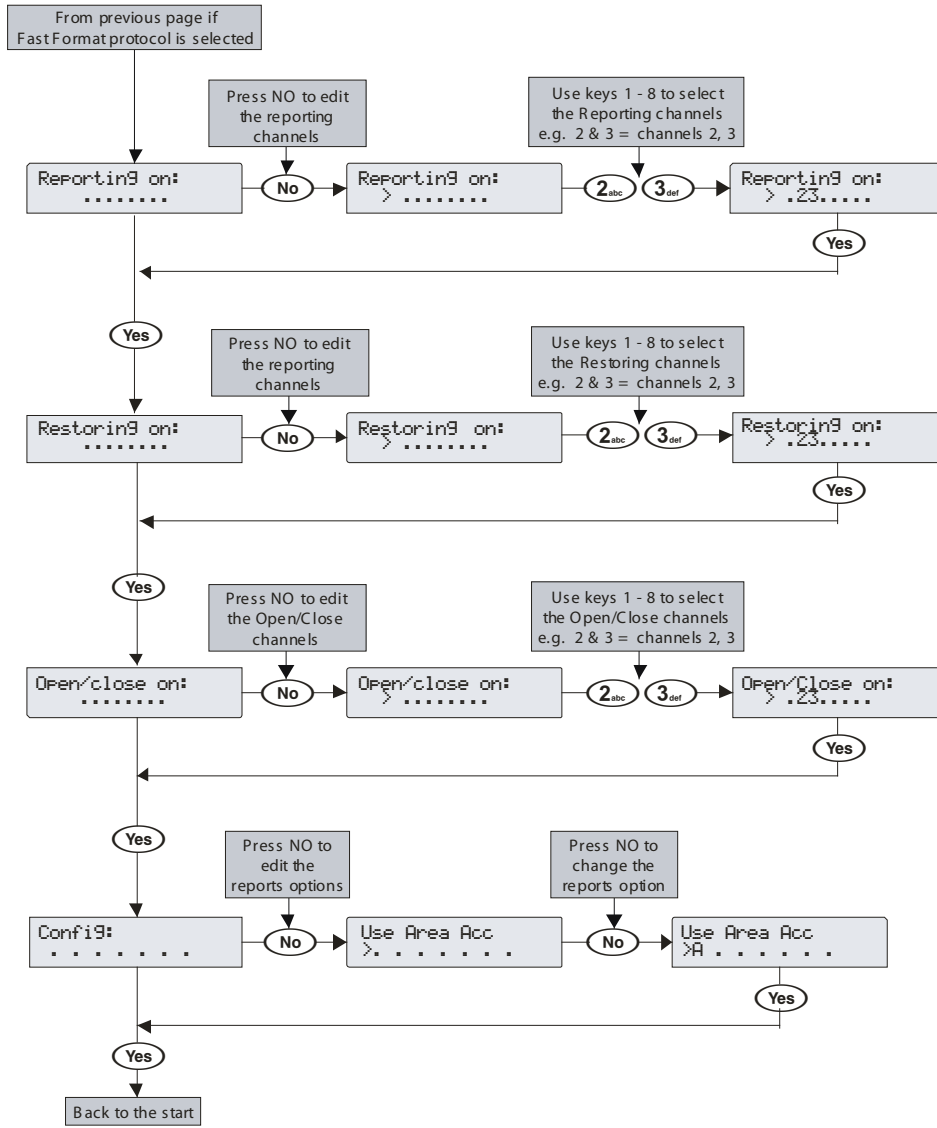

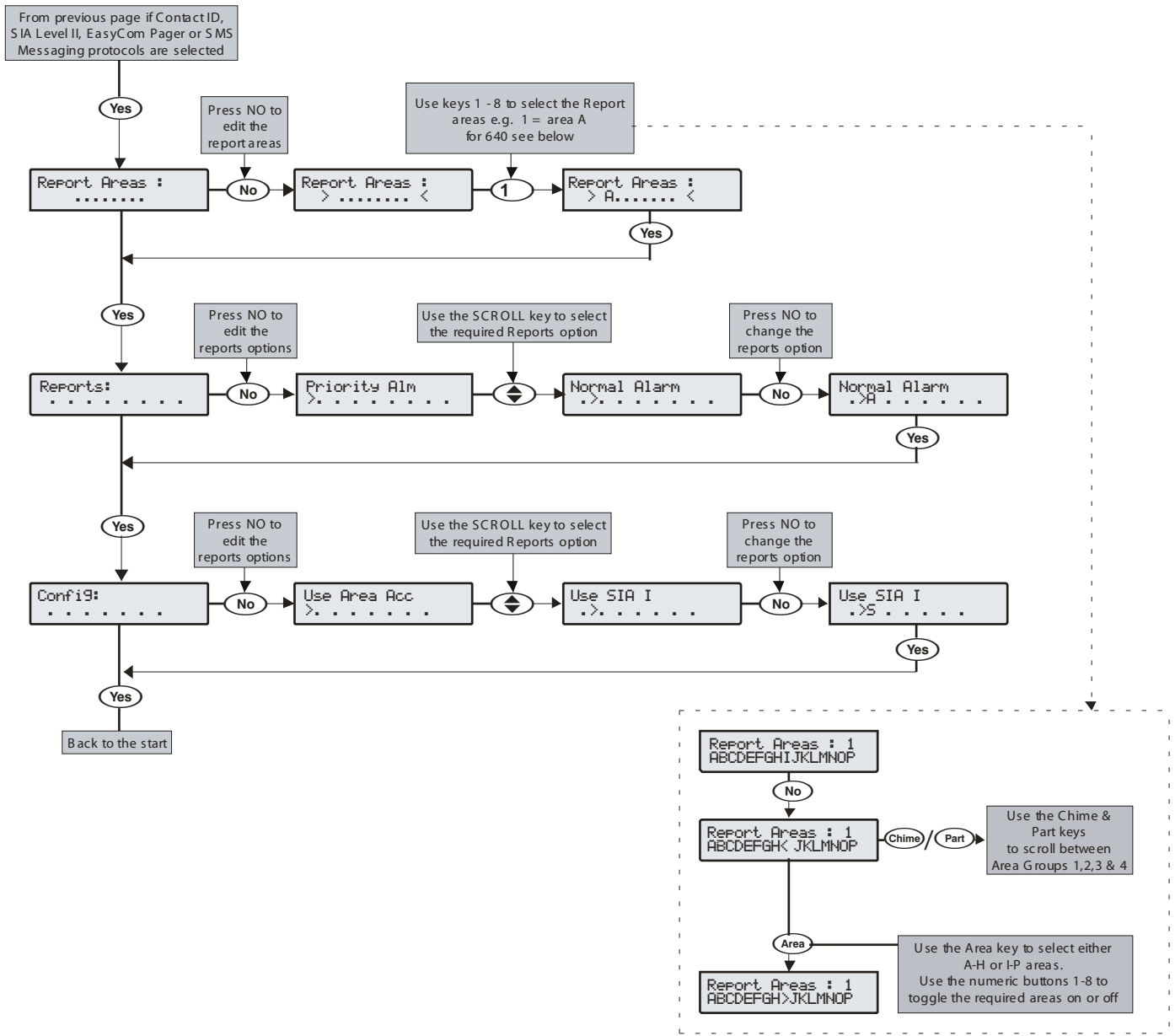

The plug-on communicator can be programmed to dial up to 3 sets of Alarm Receiving Centre (ARC) information. Each 'Set' consists of the following options:

Protocol

This is the reporting protocol that is used to communicate with the Alarm Receiving Centre. The following 4 protocols are supported:

- **Fast Format:** The panel will report using Fast Format. If this option is selected the 'Reporting Channels' must be programmed (see below)
- **Contact ID:** The panel will report using Contact ID. If this option is selected, the 'Reporting Areas' must be programmed (see below)
- **SIA Level II:** The panel will report using SIA Level II
- **EasyCom Pager:** The panel will report to an EasyCom type pager
- **SMS Messaging:** The panel will send Short Message Service (SMS) text messages to a mobile phone

Primary Telephone Number

This is the first telephone number that the communicator will dial for the Alarm Receiving Centre or the first mobile telephone number to send SMS to. Each telephone number can be up to 24 digits.

Secondary Telephone Number

This is the second telephone number that the communicator will dial for the Alarm Receiving Centre or the second mobile telephone number to send SMS to. Each telephone number can be up to 24 digits.

Account Number

This is the account number that will be reported to the Alarm Receiving Centre. Each account number can be up to 6 digits.



Each area can also have its own account number (see page 88 & 81 for details).

Dialling Attempts

This is the number of times the communicator will try to dial the Alarm Receiving Centre or Pager telephone number.



The number of dialling attempts is limited to 9. If this value is set to 0, the communicator will never dial out.

The following option is only displayed if the Fast Format protocol is selected

Reporting on

This option defines which channels report to the selected Alarm Receiving Centre.

Restoring on

This option defines which channels report a restore to the selected Alarm Receiving Centre.

Open/Close on

This option defines which channels report Open/Close to the selected Alarm Receiving Centre.

The following option is only displayed if Contact ID or SIA Level II protocols are selected

Reporting Areas

This option defines which areas report events to the selected Alarm Receiving Centre.

The following option is only displayed if Contact ID, SIA Level II or EasyCom Pager protocols are selected

Reports

This option defines which events report to the Alarm Receiving Centre when using Contact ID or SIA Level II.

P - Priority Alarm and Cancel Events

The system will report Priority alarm and cancel events to the selected Alarm Receiving Centre.

A - Normal Alarm and Cancel Events

The system will report alarm and cancel events to the selected Alarm Receiving Centre.

O - Open and Close Events

The system will report open and close events to the selected Alarm Receiving Centre.

B - Omit and Reinstate Events

The system will report omit and reinstate events to the selected Alarm Receiving Centre.

M - Maintenance Alarm Events

The system will report maintenance alarm events to the selected Alarm Receiving Centre.

T - Tamper Alarm Events

The system will report tamper alarm events to the selected Alarm Receiving Centre.

C - Test Call Events

The system will report test call events to the selected Alarm Receiving Centre.

R - Restore Events

The system will report restore events to the selected Alarm Receiving Centre.

The following option is only displayed if Fast Format Contact ID or SIA Level II protocols are selected

Config.

This option defines which secondary options are enabled.

A - Area Account

Events are reported to the Alarm Receiving Centre using the area account numbers (see page 88 for details).

S - SIA Level I / UCP

Events are reported to the Alarm Receiving Centre using SIA Level I or to an SMS Messaging Server using UCP.

R - Enable Radio-Pad

The system will use the Paknet radio-pad to report events to the selected Alarm Receiving Centre.

G - Enable GSM Module

The system will use the GSM Module to report events to the selected Alarm Receiving Centre.

A - AV Module

The AV Module will dial the Alarm Receiving Centre.

F - Use GSM First

The GSM module is the primary path when this is enabled

I - Connect Via IP

The system will use the IP Module to report events to the selected Alarm Receiving Centre.

T - Send SIA Text

Text is sent to the Alarm Receiving Centre when using SIA II (this makes the protocol SIA III)

Digi Options

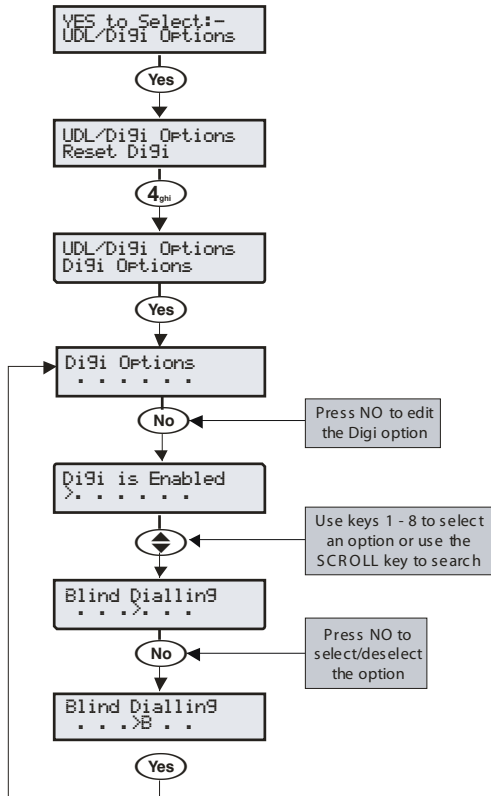

There are 6 options that control how the plug-on communicator works.

Select options by pressing keys 1 to 8 (a letter on the display means the option is selected, a Dot on the display means the option is not selected).

E - Digi is Enabled

The plug-on communicator will report all system events to the Alarm Receiving Centre.

P - Pulse Dialling

The plug-on communicator will always dial telephone numbers using pulse dialling.

3 - Pulse After 3

The plug-on communicator will always dial telephone numbers using tone dialling. However, if the Communicator fails to dial the number three times in a row, it will revert to pulse dialling for the remaining attempts.

B - Blind Dialling

The plug-on communicator will not look for a dial tone before dialling a telephone number.

U - Use MSN/Pre-Dial

The ComSDN will only answer a call when the programmed MSN/Pre-Dial telephone number is dialled.

A - Dial All Numbers

If the communicator is acknowledged by the first ARC, it will continue to dial any other programmed ARC. This is normally used when a second or third ARC is programmed with SMS Messaging.

Area Accounts 24/48/88/168

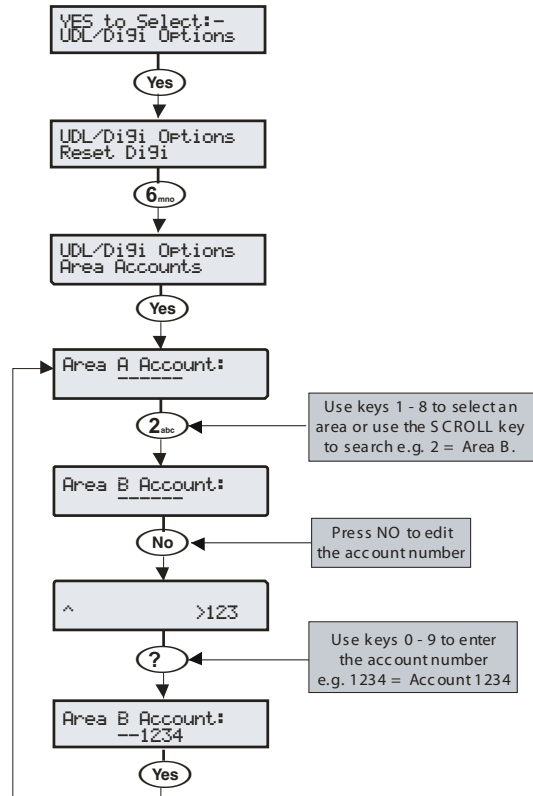

When using Fast Format, Contact ID or SIA, each area can have its own account number to identify events.

Account Numbers A to H (I to P)

This is the account number that will be reported to the Alarm Receiving Centre. Each account number can be up to 6 digits.



In order for the control panel to use the area account numbers, the area account Config. option must be enabled (see page 87 details).

Area Accounts 640

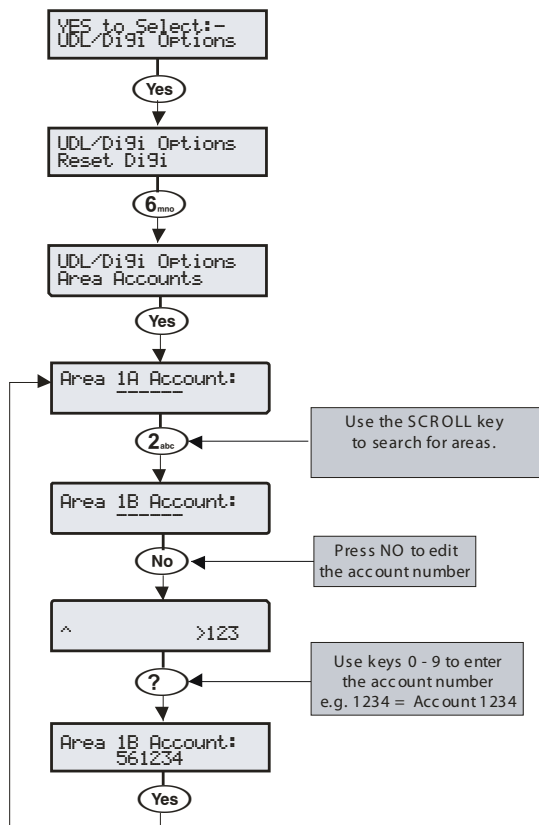

When using Fast Format, Contact ID or SIA, each area can have its own account number to identify events.

Account Numbers A to H (I to P)

This is the account number that will be reported to the Alarm Receiving Centre. Each account number can be up to 6 digits.



In order for the control panel to use the area account numbers, the area account Config. option must be enabled (see page 87 for details).

UDL Options

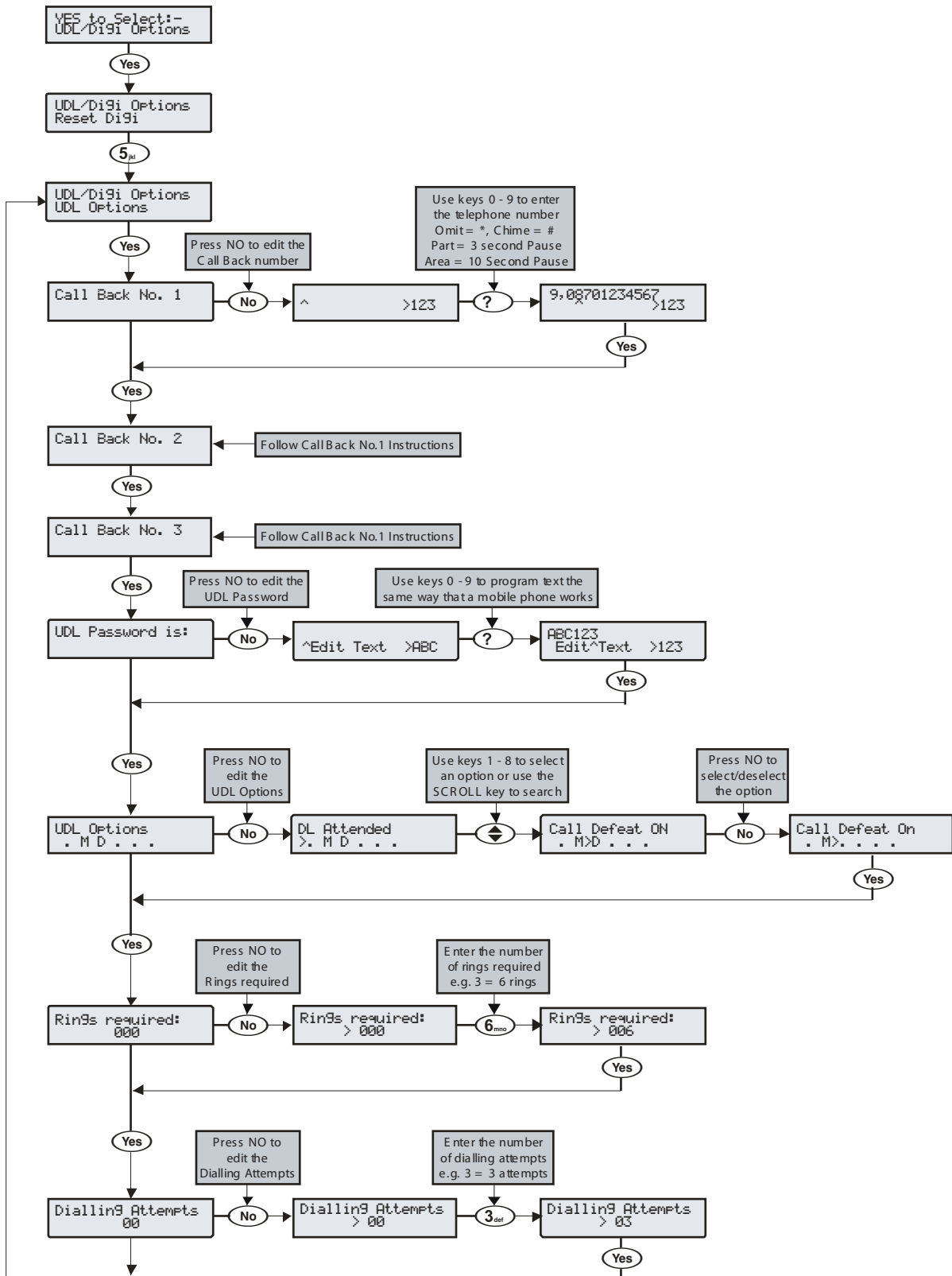

The system has the following UDL download options:

Download Call Back Number 1

This is the telephone number that is dialed by the modem when 'Call-back Number 1' is requested by the remote UDL computer. This telephone number can be up to 24 digits.

Download Call Back Number 2

This is the telephone number that is dialed by the modem when 'Call-back Number 2' is requested by the remote UDL computer. This telephone number can be up to 24 digits.

Download Call Back Number 3

This is the telephone number that is dialed by the modem when 'Call-back Number 3' is requested by the remote UDL computer. This telephone number can be up to 24 digits.

UDL Password is:

When the remote downloading computer dials into the system, the control panel compares the UDL password sent by the computer with UDL password stored in the control panel. If the passwords match, access to the control panel is granted, if they don't match, access is denied.



If more than three attempts at reporting are made with a wrong password, the modem will lock out for 4 hours or until a Master User code is entered.

The UDL password programmed in this option must also be programmed in the customer account on the remote downloading computer. This password can be up to 16 characters (numbers and letters).

If no UDL Password has been programmed, access to the control panel can be gained by using the engineers code as the UDL Password.

UDL Options

There are 6 UDL options that affect how and when access to the control panel via the *Wintex UDL* software is allowed.

Select options by pressing keys 1 to 6 (a letter on the display means the option is selected, a Dot on the display means the option is not selected).

The following UDL options are available:

A - DL Attended

The system will not allow the remote downloading computer access without user authorisation first.

M - Man Call-Back

The system will not use the automatic call back feature. The user must instruct the panel to call back the remote downloading computer.

The Auto Call-Back feature operates as follows:

- The remote downloading computer calls the control panel and establishes a connection
- The UDL password is verified and the remote downloading computer instructs the panel to call it back using one of the 3 call back numbers
- The panel hangs up and dials the requested number and re-establishes the connection with the remote downloading computer

D - Call Defeat

The modem will answer incoming calls as follows:

- The modem must detect one or more rings and the number of rings must NOT exceed the value set up in 'Rings Required'
- When the ringing stops, the panel will start a 30 second delay timer
- If the modem detects ringing before the timer expires it will answer the call immediately

L - Armed DL Limited

The panel will not allow download access when the system is armed (also see below).

A - Any Area Armed

The panel will not allow download access when any areas are armed.

K - Online RKP = Off

The control panel cannot be accessed using the 'On-line' keypad feature of the *Wintex UDL* software.

Rings Required

This counter controls the number of rings the modem needs to see before it will answer the call (Default = 003).

UDL Dial Attempt

If a 'Call-Back' is started, this option controls how many times the modem will try to call the remote downloading computer before giving up (Default = 003).



Enter the number of dialling attempts. This number is limited to 9. If this value is set to 0, the communicator will never dial out.

This only affects the modem for download access and does not affect the operation of the communicator in any way.

Setup Modules

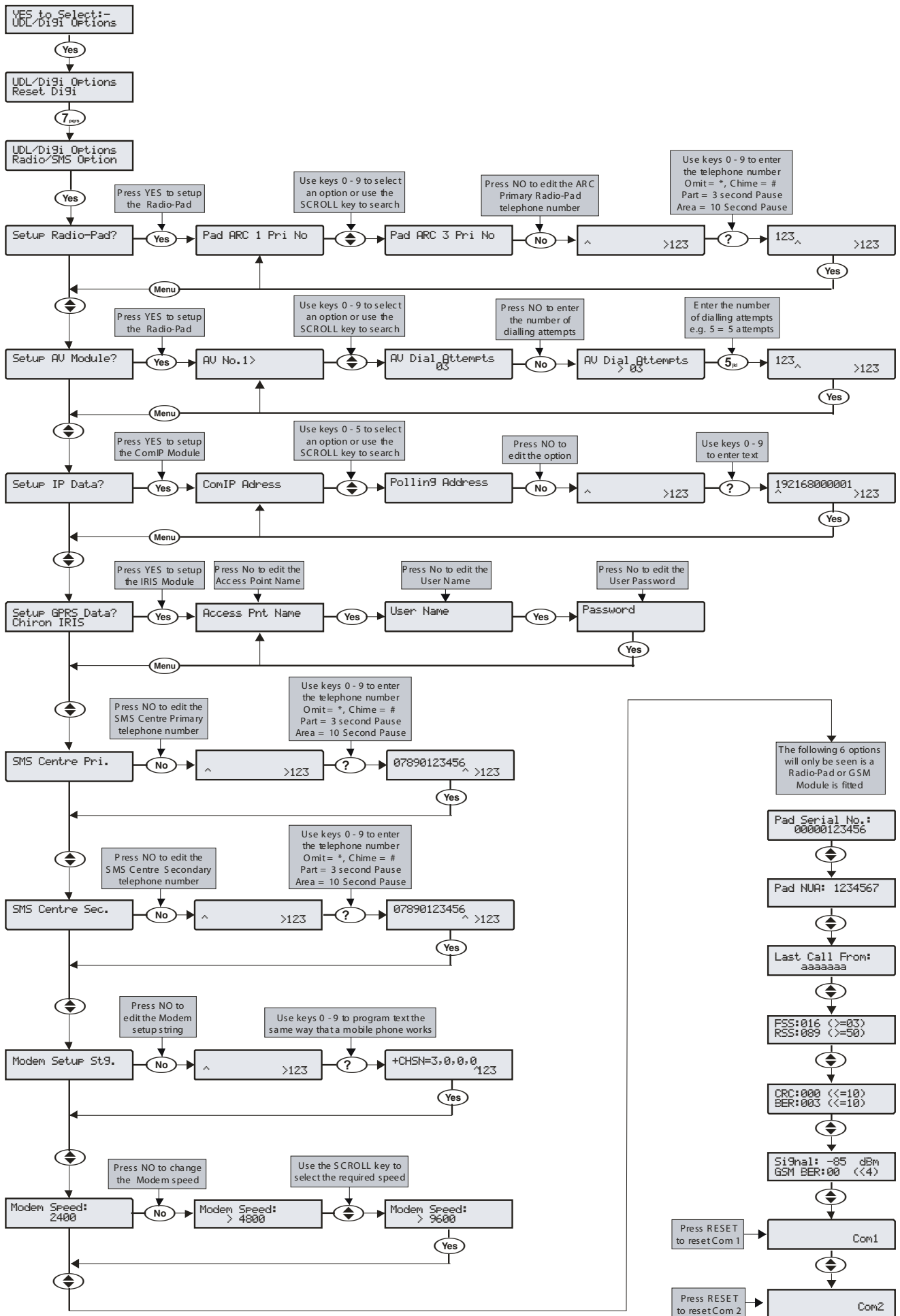

The following options are used when a Paknet Radio-Pad is connected to the control panel in order to achieve DUAL SIGNALLING to an Alarm Receiving Centre, when a MODEM (External PC or Com2400) is used to connect to the control panel or send SMS messages to mobile phones, when an AV Module is connected to the control panel in order to achieve AUDIO VERIFICATION to an Alarm Receiving Centre or when a TCP/IP Module is connected for communications over a Broadband/ADSL/DSL Line.

Setup Radio-Pad

Pad ARC 1 Pri No

This is the first number that is used by the Radio-Pad for reporting events to ARC 1.

Pad ARC 1 Sec No

This is the second number that is used by the Radio-Pad for reporting events to ARC 1.

Pad ARC 1 Prefix

This number will prefix the account number for ARC 1.

Pad ARC 2 Pri No

This is the first number that is used by the Radio-Pad for reporting events to ARC 2.

Pad ARC 2 Sec No

This is the second number that is used by the Radio-Pad for reporting events to ARC 2.

Pad ARC 2 Prefix

This number will prefix the account number for ARC 2.

Pad ARC 3 Pri No

This is the first number that is used by the Radio-Pad for reporting events to ARC 3.

Pad ARC 3 Sec No

This is the second number that is used by the Radio-Pad for reporting events to ARC 3.

Pad ARC 3 Prefix

This number will prefix the account number for ARC 3.

Radio-Pad Attempts

This is the number of times the Radio-Pad will try to dial the Alarm Receiving Centre telephone number before giving up.



The number of dialling attempts is limited to 9. If this value is set to 0, the Radio-Pad will never dial out.

Setup AV Module

AV No. 1 >

This is the first number that is dialled by the AV Module.

AV No. 3 >

This is the second number that is dialled by the AV Module.

AV No. 3 >

This is the third number that is dialled by the AV Module.

AV Dial Attempts

This is how many times the AV Module will attempt to dial before giving up.



The number of dialling attempts is limited to 9. If this value is set to 0, the AV Module will never dial out.

AV Re-Dial Delay

This is the amount of delay that the AV Module uses between re-dialling telephone numbers.

Setup IP Module

ComIP Address

This is the IP Address of the IP Module.

ComIP Port

This is the Port number of the IP Module.

ComIP Gateway

This is the Gateway IP Address that the IP Module communicates through.

ComIP Mask

This is the Subnet Mask number for the IP Module.

Polling/SMG Address

This is the IP address of a dedicated Polling or SMG Server that the IP Module might need to connect to.

Name/SMG Port

This is a descriptive name for the IP Module or SMG Port and might be used for authentication purposes.

Chiron Iris GPRS Data

Access Pnt Name

This is the GPRS Access point Name provided by Chiron

User Name

This is the APN User Name provided by Chiron

Password

This is the APN password provided by Chiron.

SMS Centres

SMS Centre Pri.

This is the first SMS centre telephone number that is used by for sending SMS to mobile phones. (Default = 07785499993).

SMS Centre Sec.

This is the second SMS centre telephone number that is used by for sending SMS to mobile phones. (Default = 07860980480)

Modem

Modem Setup Stg.

If a standard PC modem is connected to Com1 or Com2, it may require a configuration string to make it work properly (please refer to instruction manual of modem being used for details of required AT commands).



The Setup string is programmed the same way that TEXT would be programmed and has a maximum length of 16 characters.

The setup string does NOT require AT to be entered at the beginning as this is done automatically.

Modem Speed

This option allows the speed of a standard PC modem connected to Com1 or Com2 to be adjusted.

Radio-Pad Info

Pad Serial No.

This screen displays the Serial number of the Radio-Pad that is connected.

Pad NUA

This screen displays the NUA number of the Radio-Pad that is connected.

Last Call From

This screen displays the NUA number of the last Radio-Pad that communicated with the Radio-Pad that is connected to the control panel.

FSS:???(>=004), Forward Signal Strength

RSS:???(>=050), Reverse Signal Strength

This screen displays the Radio-Pad Forward (FSS) and Reverse (RSS) Signal Strength of the Radio-Pad that is connected to the control panel.



The FSS value should be greater than or equal to 4 and the RSS value should be greater than or equal to 50.

CRC:??? (<=009), **Cyclic Redundancy Check**
BER:??? (<=009), **Bit Error Rate**

This screen displays the Cyclic Redundancy Check (CRC) and Bit Rate Error (BER) of the Radio-Pad that is connected to the control panel.

NOTE The CRC and BER values should be less than 10.

GSM Info

Signal =??? dBm (<=080), **GSM Signal**
GSM BER:??? (<=004), **GSM Bit Error Rate**

This screen displays the signal strength (GSM) and Bit Rate Error (BER) of a GSM Module that is connected to the control panel.

NOTE The GSM value should be greater than or equal to 80 and the BER value should be less than 9.

Com1 Monitor Screen

This screen allows you to view the data activity of Com1. Press RESET to reset the device connected to this port.

Com2 Monitor Screen

This screen allows you to view the data activity of Com2. Press RESET to reset the device connected to this port.

Com Port Setup

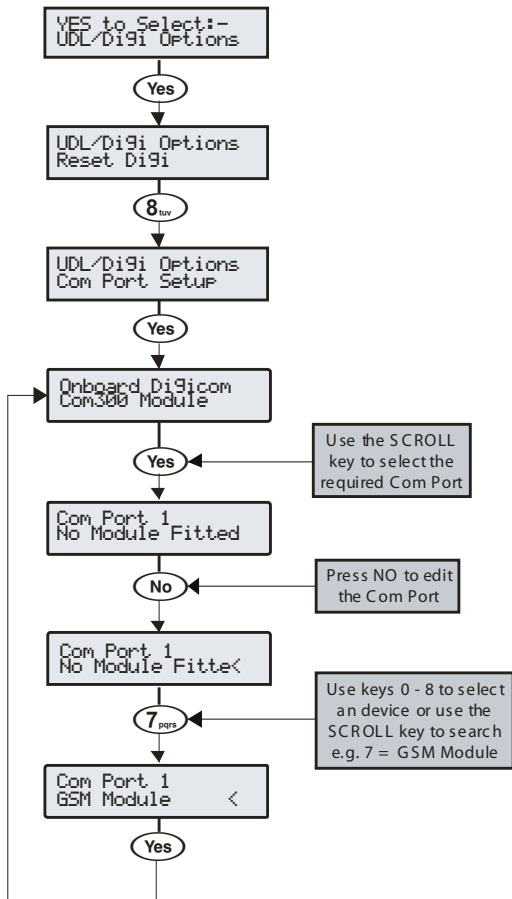

The control panel must be programmed with the type of device that are connected to each of its coms ports.

Onboard DigiCom, Com Port 1 and 2

The following devices are available for fitting to the various ports:

- 0: No Module Fitted - No Devices/PC-Com/ USB-Com
- 1: Com300 - Com300 Communicator.
- 2: Com2400 - Com2400 Communicator.
- 3: ComISDN - ComISDN Communicator.
- 4: ComIP - ComIP TCP/IP Communication Module.
- 5: Modem Unit - Standard Serial PC Modem.
- 6: Radio Pad - Paknet RP9 Radio-Pad.
- 7: GSM Module - GSM Module/Mobile Phone.
- 8: Crestron System - Crestron Home Automation System.
- 9: SIP - Serial IP Protocol.
- 10: RadioPlus - Serial Wireless Receiver.
- 11: Inovonics Radio - Inovonics Serial Wireless Receiver.
- 12: WebWayOne/Emizon - WebWayOne/Emizon UDP Module.
- 13: X-10 Control - X-10 Home Automation Module.
- 14: IRIS IP - Chiron IRIS Serial TCP/IP Module.

Onboard DigiCom

This option determines what type of device is connected to the plug-on digmodem connector on the top right hand corner of the control panel. (Default = Com300).

The following devices are available from the above list:

0 / 1 / 2 / 3

Com1

This option determines what type of device is connected to the Com1 connector on the left hand side of the control panel. (Default = No Module Fitted).

The following devices are available from the above list:

0 / 2 / 3 / 4 / 5 / 7 / 8 / 9 / 10 / 12 / 13 / 14

NOTE If any of the above devices are connected to the control panel on Com1 and a PC needs to be connected (for uploading/downloading) the device must be disconnected from Com 1 and the 'Factory Default' button pressed for 3 seconds to allow the PC to talk to the control panel.

If the PC is not connected to the control panel (or is removed) the Com port will automatically revert back to normal operation after 1 minute.

Com2

This option determines what type of device is connected to the Com2 connector on the left hand side of the control panel. (Default = No Module Fitted).

The following devices are available from the above list:

0 / 2 / 3 / 4 / 5 / 6 / 7 / 8 / 9 / 10 / 11 / 12 / 13 / 14

Com3*

This option determines what type of device is connected to the Com3 connector on the left hand side of the control panel. (Default = No Module Fitted).

The following devices are available from the above list:

0 / 2 / 3 / 4 / 5 / 6 / 7 / 8 / 9 / 10 / 11 / 12 / 13 / 14

NOTE *640 only

Expansion Port

This option determines what type of device is connected to the Expansion Port connector (Default = No Module Fitted).

Available Device Types:

- 0: No Module Fitted - No Devices
- 1: AV Module - Audio Verification Module
- 2: iD Module - 60IXD iD Module
- 3: X10 Module - X10 Controller
- 4:Memory Module -Memory Module (24/48/88/168 only)

NOTE Selecting memory module when none is fitted will prevent events being recorded to the log.

DualCom® Inside (48 Only)

Aerial Siting

ALWAYS do a site survey to find an area of strong signal before installation. Installing a Com GSM with a weak signal is bad installation practice.

The aerial should be mounted vertically at the point of strongest signal. This is usually the highest point in the building (often the loft area).

Avoid installing the aerial directly under metal roofs or within metal skinned buildings because this will reduce the signal strength and may inhibit operation completely. If this is unavoidable, the strongest signal will be found away from the metal roof or close to large external windows or skylights.

Avoid installing the aerial close (2 metres) to cable runs, ducting, structural metalwork, metal pipes, water tanks and electronic equipment, e.g. photocopiers, fax machines etc. These can have similar effects to metal roofs.

Reliable operation is unlikely with a low signal strength. If the display shows that the signal strength is 40% or lower, you should improve the signal strength. This may be achieved by repositioning the aerial. The GPRS aerial lead should not be cut, therefore repositioning the aerial may require that the Com GSM is also repositioned.

The DualCom® CS2366 Radio Test Set is ideal for surveying a site. This handheld unit can check the availability, signal strength and interference status of all surrounding Base Stations. In addition, it will identify the best location for a DualCom GPRS aerial within the building, help to avoid sources of interference and can confirm the availability of a GPRS service at the proposed site.

Where a Nokia 'Net Mon' phone is available and a Vodafone SIM Card is fitted, it may be used in the same manner as the CS2366 Radio Test Set.

Alternatively, a Vodafone mobile phone may be used to locate the point of strongest signal. The signal strength indicator is normally a bar or line at the side of the display on the mobile telephone. Note: The mobile phone MUST use the Vodafone network. A mobile phone that uses a different radio network will NOT show the correct signal strength.

This 'mobile phone' method cannot provide information on the availability, signal strength and interference status of all radio Base Stations in the surrounding area. Use of the CS2366 Radio Test Set is recommended.

When you have identified the point of the strongest signal, make a note of this point and use it when installing the Com GSM aerial.

Remember: It is always easier to find the point of strongest signal before the equipment is fitted to a wall. Moving aerials, cables, trunking etc. after installation is wasted time and effort.

Initial Setup

Please follow the instructions in INS176 to install the equipment and initiate the power up sequence. When applying power for the first time, the factory default settings **must** be loaded. DualCom Inside® cannot be setup through Wintex, so please follow the diagrams and instructions to setup DualCom® Inside. The process for enabling DualCom Inside® is as follows:-

1. Install Equipment
2. Plug Com2400 onto control panel PCB
3. Plug Com GSM onto Com port 1
 - a. Set option switches 1 & 2 to ON and 3 & 4 to OFF
4. Enter engineers mode on keypad
5. Select UDL/Digi Options
6. Com Port Setup
7. Select Com2400 as the Digicom
8. Select ComIP for Com port 1
9. Enable DualCom Inside®
10. Choose your ARC
11. Enter your Gemini Account number
12. Enter your PSTN number
13. Test the equipment

The flow diagram on the following page shows the procedure to enable and test DualCom® Inside.

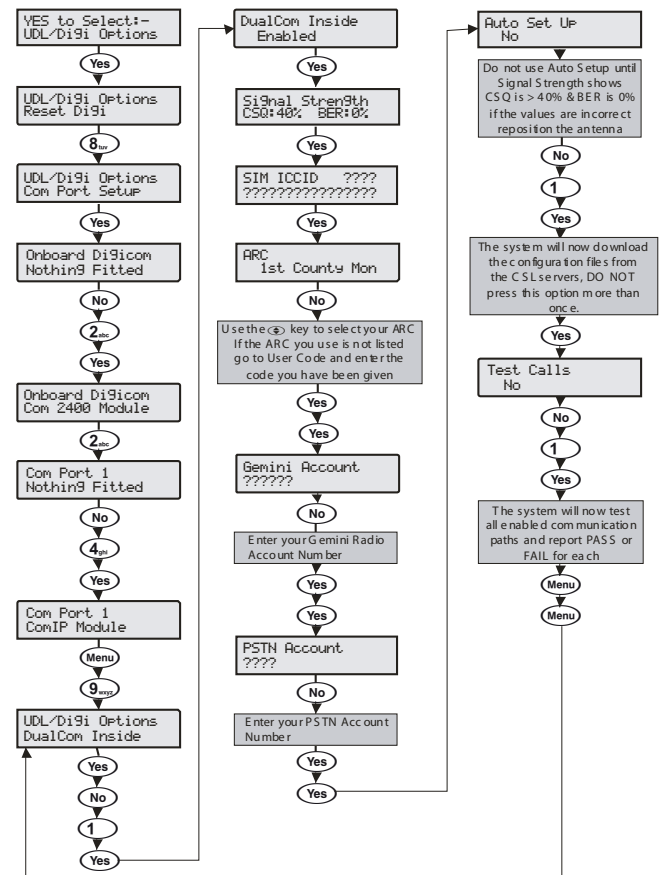

EMIZON 21 TCD

Introduction

The EMIZON 21 TCD is compatible with all Premier Elite Control Panels.

PCB Layout

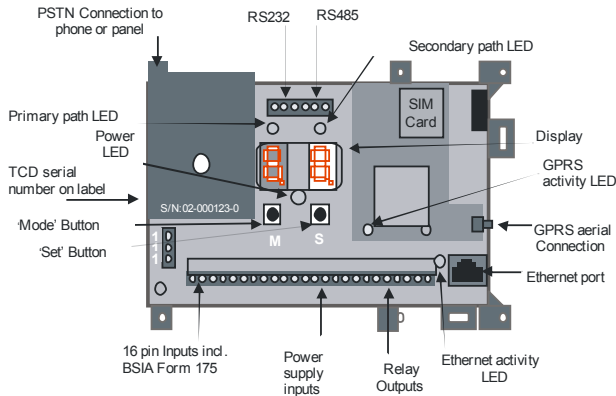

PC COM to TCD Connection

The Emizon 21 connects to the panels Via the PC-COM lead*.



*Order Part Number JAA-0001

This lead converts the TTL port to standard RS232.

You will need to remove the 9 way D-Type serial connector on the PC-COM adaptor and connect the following wires to the TCD RS232 terminals as shown in the table below.

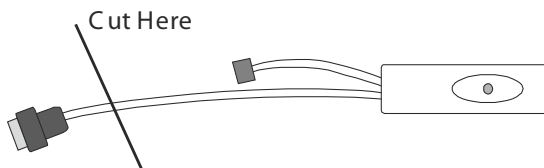

PC-Com	EMIZON 21
Black Wire	TCD GND
Yellow Wire	TCD TX
Blue Wire	TCD RX

Once you have connected the wires of the PC-COM to the TCD you then need to connect the Molex connector to Com1 or Com 2.

Panel Com Port Setup

The Com Port speed needs to be configured to 19200 baud if using Com 2 (Com 1 is set to 19200 baud at default and cannot be changed).

See page 94 (Com Port Setup).

Panel ARC Setup

To set up the ARC account only a few setting need to be made.

see page 84 (Program Digi).

- Set the reporting Protocol to **SIA** or **Contact ID**.
- Set an account number.
- Select "Connect via IP" in the protocol options.

see page 88 (Digi Options).

- Select "Enable communicator"

Panel IP Setup

The control panel communicates to the ARC via the EMIZON TCD.

The TCD's primary signalling path is via an IP network; therefore the control panel need's an IP address so that it can connect to a local network.

Ensure that the customer has filled in the "Customer IT Survey Form" provided by EMIZON.

This will give you the information you need to set up the IP data on the control.

see page 93 (Setup IP Module)

Connect the Ethernet cable between the Ethernet port on the TCD unit and the Network router.

Commissioning

Now that the programming for the EMIZON21 is complete you need to power up the TCD and wait 15 seconds (approx) and check the following –

- Flickering light on the Ethernet path LED.
- Flashing green light on the GPRS path LED.

These indicate that the signalling paths are available and that the TCD is ready to be commissioned.

Now you need to call The ARC (084404129009) with the TCD serial number that is printed on the label located on the front cover, the ARC will then associate the TCD to this specific installation on their system and activate it.

If this is the first time this TCD is being installed, you will need to wait for the "tl" indication to appear on the display and then press and hold the set button for 4 seconds.

The TCD will contact EMIZON service platform and the display will alternate between "tl" and 01, then "CA" (completely Active).

Alternate flashing decimal points indicate normal operation following a successful commission.

The GPRS and Ethernet LED's will turn green to indicate that they are communicating with the service platform.

Wintex UDL via EMIZON 21 TCD

To utilise the UDL option you will need to sign up with the Emizon UDL service.

After signing up you will be sent your security certificate along with UDL server login details.

You will also be given the server IP and port address.

You will need to enter these details in the Network details section of Panel details in Wintex.

You must also install the Emizon UDL software on to the PC you intend to use for UDL.

WebWayOne

WebWayOne integration with the control panels provides the following features 7 functions:-

- Automatic Commissioning
- ATS Monitoring and Fault Reporting
- Alarm and Fault reporting
- Remote Support
- Upload/Download
- Remote Maintenance

The connection is via a TTL link to a Com Port on the control panel. You will need the following to connect and setup the module:-

- WebWayOne cable 05-0246
- Wintex software

The WebWay solution is quick and easy to install and commission with your chosen ARC.

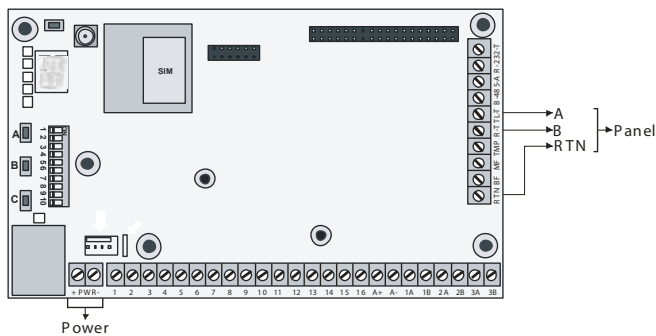

The Auto Take On process completes the installation. The WebWay servers automatically programme the module to work seamlessly with the panel to enable SIA alarms, Upload Download and secure remote access using the Texecom Wintex software.

Automatic SIA 3 with text enriched messages

All alarms generated by the Alarm System are automatically sent to the AMS using SIA. SIA messages provide a full audit trail of an event - which detector, location, time and date, and a permanent record of every alarm. Messages for set and unset include who, where, time, and date, all recorded.

Serial Panel Connection

Connect the 05-0246 connector cable to the Texecom onto Com Port 1. Com port 2 usually has a local PC or other peripheral equipment connected.

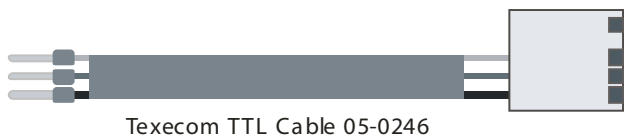

Texecom TTL Cable 05-0246

WebWay SPT	Texecom
T - Red	Com Port 1
R - Green	
RTN - Blue	

Connect the WebWay **PWR + and -** to any relevant Power (+12V/+24V) and Ground (0V) terminals.

The Texecom panel configuration is uploaded via the **Wintex** software and downloaded to the panel on com port 2 from a local PC. The following requires configuring in the panel.

Programming the Control Panel

Digi Options

- Enable communicator must be ticked
- UDL passcode (set in the panel) must match.
- Dial attempts 1, ring before answer 3

NOTE See page 88

In ARC's

1. Account number (site ID)
2. SIA Level 2/3
3. Connect Via IP - ticked
4. Send SIA text – ticked

NOTE See page 84

In Radio-Pad and Com Port options

1. Com Port 1 – WebWayOne module
2. Local IP address 127.0.0.1
3. Local IP port 50561
4. Gateway 127.0.0.1
5. Subnet Mask 255.255.255.0
6. Name/SMG port 50561

NOTE See page 93

Wintex Programming

All other settings are done by the Wintex Comms menu This can be configured on a local PC plugged on to Com Port 2 with the Module running on Com Port 1 or vice versa.

Digi Options

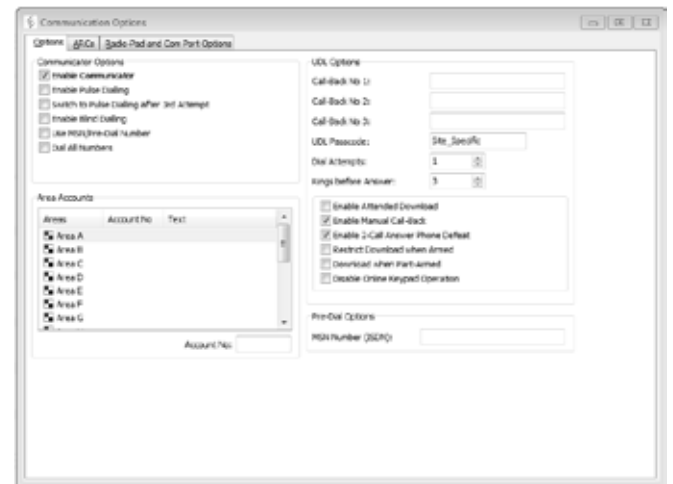

Enter the options shown including the callback number.

ARC's

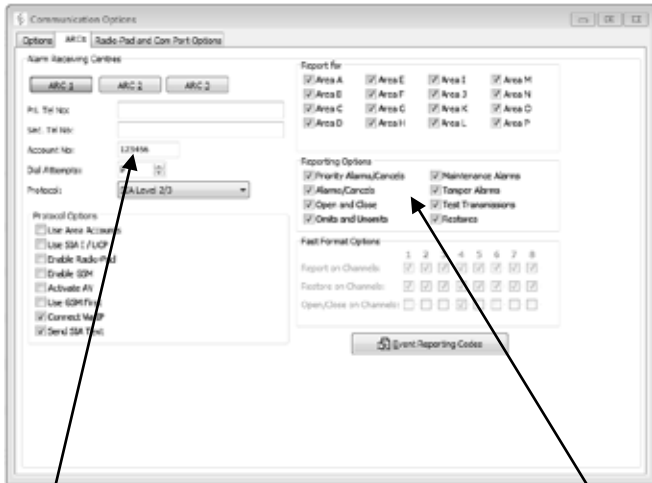

“Account No:” should match the ARC Site/Chip ID and tick the relevant trigger event boxes relevant to the premises.

- Connect Via IP Checked
- Protocol SIA Level2/3

Radio Pad and Com Port Options

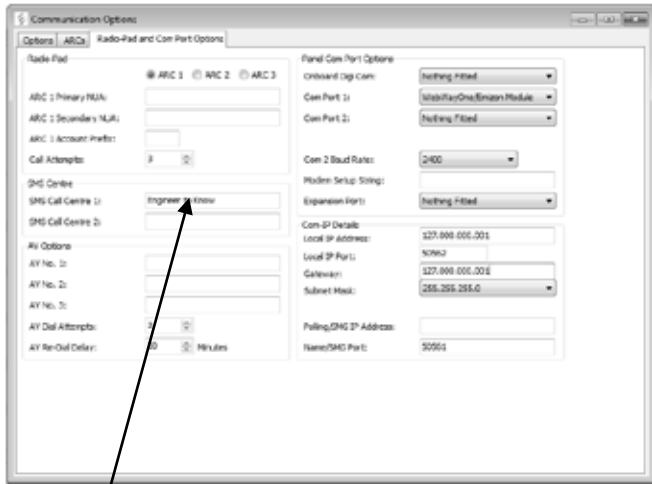

If the SMS call centre is utilised the engineer should enter the appropriate number and it should be configured under:

SMS Call Centre 1&2

The SMS centre telephone number is used to send SMS text messages to mobile phones. (Default = 07860980480).

Com-IP Details

Com-IP Details	
Local IP Address:	127.000.000.001
Local IP Port:	50562
Gateway:	127.000.000.001
Subnet Mask:	255.255.255.0
Polling/SMG IP Address:	
Name/SMG Port:	50561



if the panel is being programmed with a laptop on com port 2, and the WebWay is connected to com port 1 the SPT will be lost from the panel until the Wintex session is closed.

Chiron IRIS

The Chiron IRIS Touch range of communicators offers a way of transmitting alarm signals to an Alarm Receiving Centre (ARC) over an Ethernet (IP) path, GPRS path, and PSTN path or a Combination as opposed to using a traditional PSTN lines.

To connect to the control panel an RS232 Interface is required. For the IRIS 400 series this is a modified PC-Com JAA-0001 and for the IRIS 600 series is a Chiron Tex 600 lead.

The TTL connection is made to either Com1 or Com 2 on the Control panel.

PCB Layout

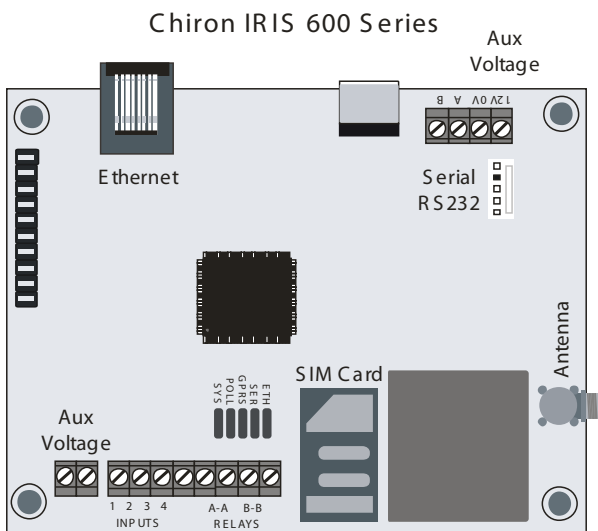
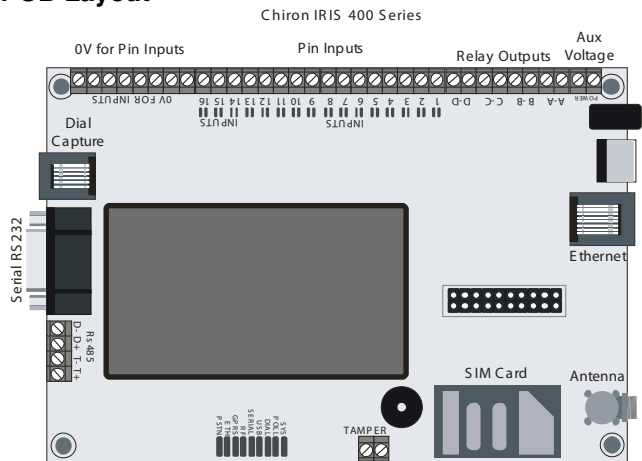

PC Com Modification

Cut the DB9 Male end of off the PC Com and wire as follows

IRIS RS232 (DB9 Female)	PC Com
Pin 2	Yellow
Pin 3	Blue
Pin 5	Black

Tex600 Lead

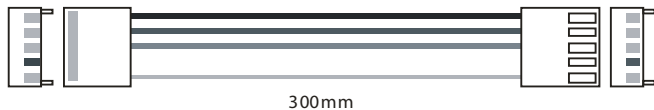

Programming

For both Alarms and Wintex upload/download the following should be programmed.

UDL/DIGI Options

For full details on the options listed please see page 84 to 94

Program Digi

- Arc 1 Protocol i.e. Fast Format, Contact ID, or SIA level 2/3.
- Primary No Set this to the IP address of the Monitoring Centre in a 12 digit format 80.176.196.135 = 080176196135
- Secondary No Leave blanks as the IRIS System will receive the secondary number from the Monitoring Centre Secure Apps platform.
- Account Number Enter in the account number from the Monitoring Centre, 4or 6 digits.
- Dialler Attempts Leave as the default 3
- Report options The Reporting Options will change depending on the alarm format selected, please set up the various reporting option for the Alarm event you wish to send to the Monitoring Centre
- Config Enable the Connect via IP (Key press 7).

Digi Options

Enable the Digi (key press 1) you should now see E on option screen now.

UDL Options

UDL Password Must match the UDL password in Wintex

Setup Modules

- Setup IP Data
 - 1 = ComIP Address for the IRIS e.g. 192.168.0.10
 - 2 = ComIP Port
 - 3 = ComIP Gateway e.g. 192.168.001.001

NOTE To use DHCP leave the ComIP Address & Gateway blank

- ComIP Netmask Enter the network subnet mask i.e. 255.255.255.000
- Polling/SMG IP Set this to the IP address of the Monitoring Centre in a 12 digit format i.e. 80.176.196.135 = 080176196135.

Com Port Setup

Com Port 1 Set to IRIS IP Module

GPRS Info

To programme the APN and the User Name & Password please see page 93

To programme and commission any other features of the IRIS units please refer to the Chiron IRIS installation manual.

Zone Alarm Reporting Codes

The Reporting codes for Contact ID and SIA are fully configurable, however these codes can only be changed using *Wintex* downloading software.

The following tables show the default codes for each event on the system:

Default Zone Event Codes

No	Zone Type	Event	Reporting Group	Contact ID	SIA
00	Entry/Exit 1	Alarm	Alarm	134	BA
		Alarm Restore	Restore	134	BH
		Omit	Omit/Reinstate	573	BB
		Reinstate	Omit/Reinstate	573	BU
01	Entry/Exit 2	Alarm	Alarm	134	BA
		Alarm Restore	Restore	134	BH
		Omit	Omit/Reinstate	573	BB
		Reinstate	Omit/Reinstate	573	BU
02	Guard	Alarm	Alarm	132	BA
		Alarm Restore	Restore	132	BH
		Omit	Omit/Reinstate	573	BB
		Reinstate	Omit/Reinstate	573	BU
03	Guard Access	Alarm	Alarm	132	BA
		Alarm Restore	Restore	132	BH
		Omit	Omit/Reinstate	573	BB
		Reinstate	Omit/Reinstate	573	BU
04	24Hr Audible	Alarm	Tamper	133	BA
		Alarm Restore	Restore	133	BH
		Omit	Omit/Reinstate	572	BB
		Reinstate	Omit/Reinstate	572	BU
05	24Hr Silent	Alarm	Tamper	133	BA
		Alarm Restore	Restore	133	BH
		Omit	Omit/Reinstate	572	BB
		Reinstate	Omit/Reinstate	572	BU
06	Audible PA	Alarm	Priority Alarm	123	PA
		Alarm Restore	Restore	123	PH
		Omit	Omit/Reinstate	573	PB
		Reinstate	Omit/Reinstate	573	PU
07	Silent PA	Alarm	Priority Alarm	122	HA
		Alarm Restore	Restore	122	HH
		Omit	Omit/Reinstate	573	HB
		Reinstate	Omit/Reinstate	573	HU
08	Fire Alarm	Alarm	Priority Alarm	110	FA
		Alarm Restore	Restore	110	FH
		Omit	Omit/Reinstate	571	FB
		Reinstate	Omit/Reinstate	571	FU
09	Medical	Alarm	Priority Alarm	100	MA
		Alarm Restore	Restore	100	MH
		Omit	Omit/Reinstate	572	MB
		Reinstate	Omit/Reinstate	572	MU
10	24Hr Gas Alarm	Alarm	Tamper	151	GA
		Alarm Restore	Restore	151	GH
		Omit	Omit/Reinstate	572	GB
		Reinstate	Omit/Reinstate	572	GU

No	Zone Type	Event	Reporting Group	Contact ID	SIA
11	Auxiliary Alarm	Alarm	Tamper	150	UA
		Alarm Restore	Restore	150	UH
		Omit	Omit/Reinstate	572	UB
		Reinstate	Omit/Reinstate	572	UU
12	24Hr Tamper Alarm	Alarm	Tamper	137	TA
		Alarm Restore	Restore	137	TR
		Omit	Omit/Reinstate	572	TB
		Reinstate	Omit/Reinstate	572	TU
13	Exit Terminator	Alarm	Open/Close	---	--
		Alarm Restore	Open/Close	---	--
		Omit	Omit/Reinstate	570	UB
		Reinstate	Omit/Reinstate	570	UU
14	Keyswitch - Momentary	Alarm	Open/Close	409	OP
		Alarm Restore	Open/Close	409	CL
		Omit	Omit/Reinstate	570	UB
		Reinstate	Omit/Reinstate	570	UU
15	Keyswitch - Latching	Alarm	Open/Close	409	OP
		Alarm Restore	Open/Close	409	CL
		Omit	Omit/Reinstate	570	UB
		Reinstate	Omit/Reinstate	570	UU
16	Security Key	Alarm	Open/Close	421	DK
		Alarm Restore	Open/Close	421	DG
		Omit	Omit/Reinstate	570	UB
		Reinstate	Omit/Reinstate	570	UU
17	Omit Key	Alarm	Omit/Reinstate	---	--
		Alarm Restore	Omit/Reinstate	---	--
		Omit	Omit/Reinstate	570	UB
		Reinstate	Omit/Reinstate	570	UU
18	Custom	Alarm	Omit/Reinstate	---	--
		Alarm Restore	Omit/Reinstate	---	--
		Omit	Omit/Reinstate	570	UB
		Reinstate	Omit/Reinstate	570	UU
19	Confirmed PA Audible	Alarm	Priority Alarm	123	PA
		Alarm Restore	Restore	123	PH
		Omit	Omit/Reinstate	573	PB
		Reinstate	Omit/Reinstate	573	PU
20	Confirmed PA Silent	Alarm	Priority Alarm	122	HA
		Alarm Restore	Restore	122	HH
		Omit	Omit/Reinstate	573	HB
		Reinstate	Omit/Reinstate	573	HU

Non-Zone Event Types

The default Non-Zone Event codes are as follows:

No	Type	Event	Reporting Group	Contact ID	SIA	ID
22	Keypad Medical	Alarm	Priority Alarm	100	MA	Keypad No *
		Restore	Restore	100	MH	Keypad No *
23	Keypad Fire	Alarm	Priority Alarm	115	FA	Keypad No *
		Restore	Restore	115	FH	Keypad No *
24	Keypad Audible PA	Alarm	Priority Alarm	120	PA	Keypad No *
		Restore	Restore	120	PH	Keypad No *
25	Keypad Silent PA	Alarm	Priority Alarm	122	PA	Keypad No *
		Restore	Restore	122	PH	Keypad No *
26	Duress Code Alarm	Alarm	Priority Alarm	121	HA	User No
		Restore	Restore -	122	HH	User No
27	Alarm Active	Alarm	Not Reported	-	-	-
		Restore	Not Reported	-	-	-
28	Bell Active	Alarm	Not Reported	-	-	-
		Restore	Not Reported	-	-	-
29	Zones Locked Out	Alarm	Alarm	130	BA	Zone No
		Restore	Not Reported	-	-	-
30	Verified Cross Zone Alarm	Alarm	Alarm	130	BV	00
		Restore	Not Reported	-	-	-
31	User Code	Alarm	Not Reported	-	-	User No
		Restore	Not Reported	-	-	-
32	Exit Started	Alarm	Not Reported	-	-	Keypad No
		Restore	Not Reported	-	-	-
33	Exit Error (Arming Failed)	Alarm	Open/Close	457	EE	00
		Restore	Not Reported	-	-	-
34	Entry Started	Alarm	Not Reported	-	-	-
		Restore	Not Reported	-	-	-
35	Area Arm Suite	Alarm	Open/Close	-	-	Suite No 1 - 8
		Restore	Open/Close	-	-	-
36	Armed with Line Fault	Alarm	Not Reported	-	-	User No
		Restore	Not Reported	-	-	-
37	Open/Close (Full Arm)	Alarm	Open/Close	401	OP	User No
		Restore	Open/Close	401	CL	User No
38	Open/Close (Part Arm)	Alarm	Open/Close	401	OP	User No
		Restore	Open/Close	401	CL	User No
39	Auto Open/Close	Alarm	Open/Close	403	OA	00
		Restore	Open/Close	403	CA	00
40	Auto Arm Deferred	Alarm	Open/Close	405	CE	User No
		Restore	Open/Close	-	-	-
41	Open After Alarm (Alarm Abort)	Alarm	Open/Close	406	OR	00
		Restore	Not Reported	-	-	-
42	Remote Open/Close	Alarm	Open/Close	407	OP	00
		Restore	Open/Close	407	CL	00
43	Quick Arm	Alarm	Not Reported	-	-	-
		Restore	Open/Close	408	CL	Keypad No *
44	Recent Closing	Alarm	Open/Close	459	CR	00
		Restore	Not Reported	-	-	-
45	Reset After Alarm	Alarm	Restore	-	-	Reset ID ****
		Restore	Not Reported	-	-	-
46	Power Output Fault	Alarm	Maintenance	300	YP	Device ID **
		Restore	Restore	300	YQ	Device ID **
47	AC Fail	Alarm	Maintenance	301	AT	00
		Restore	Restore	301	AR	00

No	Type	Event	Reporting Group	Contact ID	SIA	ID
48	Low Battery	Alarm	Maintenance	302	YT	00
		Restore	Restore	302	YR	00
49	System Power Up	Alarm	Maintenance	305	RR	00
		Restore	Not Reported	-	-	-
50	System Over Voltage	Alarm	Maintenance	321	YA	00
		Restore	Restore	321	YH	00
51	ATS Path Fault	Alarm	Maintenance	351	LT	Line Fault ID ***
		Restore	Restore	351	LR	Line Fault ID ***
52	Fail to Communicate	Alarm	Maintenance	354	YC	00
		Restore	Not Reported	-	-	-
53	Download Start	Alarm	Maintenance	411	RB	00
		Restore	Not Reported	-	-	-
54	Download End	Alarm	Maintenance	412	RS	-
		Restore	Not Reported	-	-	-
55	Log Capacity Alert (80%)	Alarm	Maintenance	623	JL	00
		Restore	Not Reported	-	-	-
56	Date Changed	Alarm	Maintenance	625	JD	User No
		Restore	Not Reported	-	-	-
57	Time Changed	Alarm	Maintenance	625	JT	User No
		Restore	Not Reported	-	-	-
58	Installer Programming Start	Alarm	Maintenance	627	LB	User No
		Restore	Not Reported	-	-	-
59	Installer Programming End	Alarm	Maintenance	628	LS	User No
		Restore	Not Reported	-	-	-
60	Panel Box Tamper	Alarm	Tamper	145	TA	00
		Restore	Restore	145	TR	00
61	Bell Tamper	Alarm	Tamper	145	TA	Device ID **
		Restore	Restore	145	TR	Device ID **
62	Auxiliary Tamper	Alarm	Tamper	145	TA	Device ID **
		Restore	Restore	145	TR	Device ID **
63	Expander Tamper	Alarm	Tamper	145	TA	Device ID **
		Restore	Restore	145	TR	Device ID **
64	Keypad Tamper	Alarm	Tamper	145	TA	Keypad No *
		Restore	Restore	145	TR	Keypad No *
65	Expander Trouble (Network Error)	Alarm	Tamper	333	ET	Device ID **
		Restore	Restore	333	ER	Device ID **
66	Keypad Trouble (Network Error)	Alarm	Tamper	333	ET	Keypad No *
		Restore	Restore	333	ER	Keypad No *
67	Fire Zone Tamper	Alarm	Tamper	373	FT	Zone No
		Restore	Restore	373	FJ	Zone No
68	Zone Tamper	Alarm	Tamper	383	TA	Zone No
		Restore	Restore	383	TR	Zone No
69	Keypad Lockout	Alarm	Tamper	421	JA	Keypad No *
		Restore	Not Reported	-	-	-
70	Code Tamper Alarm	Alarm	Tamper	421	JA	Keypad No *
		Restore	Not Reported	-	-	-
71	Soak Test Alarm	Alarm	Test	-	-	Zone No
		Restore	Restore	-	-	Zone No
72	Manual Test Call	Alarm	Test	601	RX	00
		Restore	Not Reported	-	-	-
73	Automatic Test Call	Alarm	Test	602	RP	00
		Restore	Not Reported	-	-	-
74	User Walk Test Start/End	Alarm	Test	607	TS	User No
		Restore	Restore	607	TE	User No

No	Type	Event	Reporting Group	Contact ID	SIA	ID
75	NVM Defaults Loaded	Alarm	Not Reported	-	-	Zone No
		Restore	Not Reported	-	-	Zone No
76	First Knock	Alarm	Not Reported	-	-	-
		Restore	Not Reported	-	-	-
77	Door Access	Alarm	Not Reported	-	-	-
		Restore	Not Reported	-	-	-
78	Part Arm 1	Alarm	Not Reported	-	-	-
		Restore	Close	401	CL	User No
79	Part Arm 2	Alarm	Not Reported	-	-	-
		Restore	Close	401	CL	User No
80	Part Arm 3	Alarm	Not Reported	-	-	-
		Restore	Close	401	CL	User No
81	Auto Arming Start	Alarm	Not Reported	-	-	-
		Restore	Close	401	CL	000
82	Confirmed Alarm	Alarm	Alarm	139	BV	Zone No
		Restore	Not Reported	-	-	-
83	Prox TAG	Alarm	Not Reported	-	-	-
		Restore	Not Reported	-	-	-
84	Access Code Changed/Deleted	Alarm	Not Reported	-	-	-
		Restore	Not Reported	-	-	-
85	Arm Failed	Alarm	Not Reported	-	-	-
		Restore	Not Reported	-	-	-
86	Log Cleared	Alarm	Maintenance	-	-	-
		Restore	Not Reported	401	CL	000
87	iD Loop Shorted	Alarm	Tamper	145	TA	000
		Restore	Restore	145	TR	-
88	Communication Port	Alarm	Maintenance	-	-	000
		Restore	Restore	-	-	000
89	TAG System Exit (Batt. OK)	Alarm	Not Reported	-	-	Zone No
		Restore	Not Reported	-	-	Zone No
90	TAG System Exit (Batt. LOW)	Alarm	Not Reported	-	-	-
		Restore	Not Reported	-	-	-
91	TAG System Entry (Batt. OK)	Alarm	Not Reported	-	-	-
		Restore	Not Reported	-	-	-
92	TAG System Entry (Batt. LOW)	Alarm	Not Reported	-	-	-
		Restore	Not Reported	-	-	-
93	Microphone Activated	Alarm	Not Reported	-	-	-
		Restore	Not Reported	-	-	-
94	AV Cleared Down	Alarm	Not Reported	-	-	-
		Restore	Not Reported	-	-	-
95	Monitored Alarm	Alarm	Alarm	220	BA	Zone No
		Restore	Restore	220	BH	Zone No
96	Expander Low Voltage	Alarm	Maintenance	143	ET	Device No
		Restore	Restore	143	ER	Device No
97	Supervision Fault	Alarm	Maintenance	355	UT	Zone No
		Restore	Restore	355	UJ	Zone No
98	PA From Remote FOB	Alarm	Priority Alarm	121	121	Zone No
		Restore	Restore	HA	HH	Zone No
99	RF Device Low Battery	Alarm	Maintenance	384	XT	Zone/User No
		Restore	Restore	384	XR	Zone/User No
100	Site Data Changed	Alarm	Maintenance	-	-	-
		Restore	Restore	-	-	-
101	Radio Jamming	Alarm	Maintenance	344	XQ	000
		Restore	Restore	344	-	000

No	Type	Event	Reporting Group	Contact ID	SIA	ID
102	Test Call Passed	Alarm	Not Reported	-	-	-
		Restore	Not Reported	-	-	-
103	Test Call Failed	Alarm	Not Reported	-	-	-
		Restore	Not Reported	-	-	-
104	Zone Fault	Alarm	Maintenance	380	UT	Zone No
		Restore	Restore	380	UJ	Zone No
105	Zone Masked	Alarm	Alarm	380	UT	Zone No
		Restore	Restore	380	UJ	Zone No
106	Faults Overridden	Alarm	Maintenance	-	-	000
		Restore	Not Reported	-	-	000
107	PSU AC Fail	Alarm	Maintenance	301	AT	Device No
		Restore	Restore	301	AR	Device No
108	PSU Low Battery Fail	Alarm	Maintenance	302	YT	Device No
		Restore	Restore	302	YR	Device No
109	PSU Low Output Fail	Alarm	Maintenance	300	YP	Device No
		Restore	Restore	300	YQ	Device No
110	PSU Tamper	Alarm	Tamper	333	TA	Device No
		Restore	Restore	333	TR	Device No
111	Door Access	Alarm	Open	422	DG	Device No
		Restore	Not Reported	-	-	-
112	CIE Reset	Alarm	Maintenance	305	RR	000
		Restore	Not Reported	-	-	000
113	Remote Command Via Com Port					
114	User Added	Alarm	Not Reported	-	-	-
		Restore	Not Reported	-	-	-
115	User Deleted	Alarm	Not Reported	-	-	-
		Restore	Not Reported	-	-	-
116	Confirmed PA	Alarm	Priority Alarm	139	BV	Zone No
		Restore	Not Reported	-	-	-
117	User Ack	Alarm	Not Reported	-	-	-
		Restore	Not Reported	-	-	-
118	Power Unit Failures	Alarm	Maintenance Alarm	-	YP	-
		Restore	Maintenance Restore	-	YQ	-
119	Charger Fault	Alarm	Maintenance Alarm	-	YP	-
		Restore	Maintenance Restore	-	YQ	-

Tamper Fault ID ***

Panel ID is transmitted as follows:

Device	ID
Panel	000

Keypad ID is transmitted as follows:

	Network							
RKP	1	2	3	4	5	6	7	8
1	11	21	31	41	51	61	71	81
2	12	22	32	42	52	62	72	82
3	13	23	33	43	53	63	73	83
4	14	24	34	44	54	64	74	84
5	15	25	35	45	55	65	75	85
6	16	26	36	46	56	66	76	86
7	17	27	37	47	57	67	77	87
8	18	28	38	48	58	68	78	88

Expander ID is transmitted as follows:

	Network							
EXP	1	2	3	4	5	6	7	8
1	11	21	31	41	51	61	71	81
2	12	22	32	42	52	62	72	82
3	13	23	33	43	53	63	73	83
4	14	24	34	44	54	64	74	84
5	15	25	35	45	55	65	75	85
6	16	26	36	46	56	66	76	86
7	17	27	37	47	57	67	77	87
8	18	28	38	48	58	68	78	88

ATS Path Fault ID ***

Line Fault ID is transmitted as follows:

Device	ID
Panel	00
RedCARE	01
Com 300/Com 2400	02
Com IP	002

Expander ID is transmitted as follows:

	Network							
EXP	1	2	3	4	5	6	7	8
1	11	21	31	41	51	61	71	81
2	12	22	32	42	52	62	72	82
3	13	23	33	43	53	63	73	83
4	14	24	34	44	54	64	74	84
5	15	25	35	45	55	65	75	85
6	16	26	36	46	56	66	76	86
7	17	27	37	47	57	67	77	87
8	18	28	38	48	58	68	78	88

Reset ID ****

Reset ID is transmitted as follows:

Device	ID
Panel (RR)	00
Engineer	01
Anti-Code	02
RedCARE	03
Keyswitch	04
User	05
Wintex	07

Expander ID is transmitted as follows:

	Network							
EXP	1	2	3	4	5	6	7	8
1	11	21	31	41	51	61	71	81
2	12	22	32	42	52	62	72	82
3	13	23	33	43	53	63	73	83
4	14	24	34	44	54	64	74	84
5	15	25	35	45	55	65	75	85
6	16	26	36	46	56	66	76	86
7	17	27	37	47	57	67	77	87
8	18	28	38	48	58	68	78	88

Power Fault ID ****

Reset ID is transmitted as follows:

Device	ID
Bell Under Voltage	00
Digi Under Voltage	01
System Under Voltage	02
Aux Under Voltage	03
Battery Under Voltage	04
Network 1 Under Voltage	05
Network 2 Under Voltage*	06
Network 3 Under Voltage**	07
Network 4 Under Voltage**	08
Network 5 Under Voltage**	09
Network 6 Under Voltage**	10
Network 7 Under Voltage**	11
Network 8 Under Voltage**	12

*168 & 640 Only

**640 Only

5.8 Setup Users

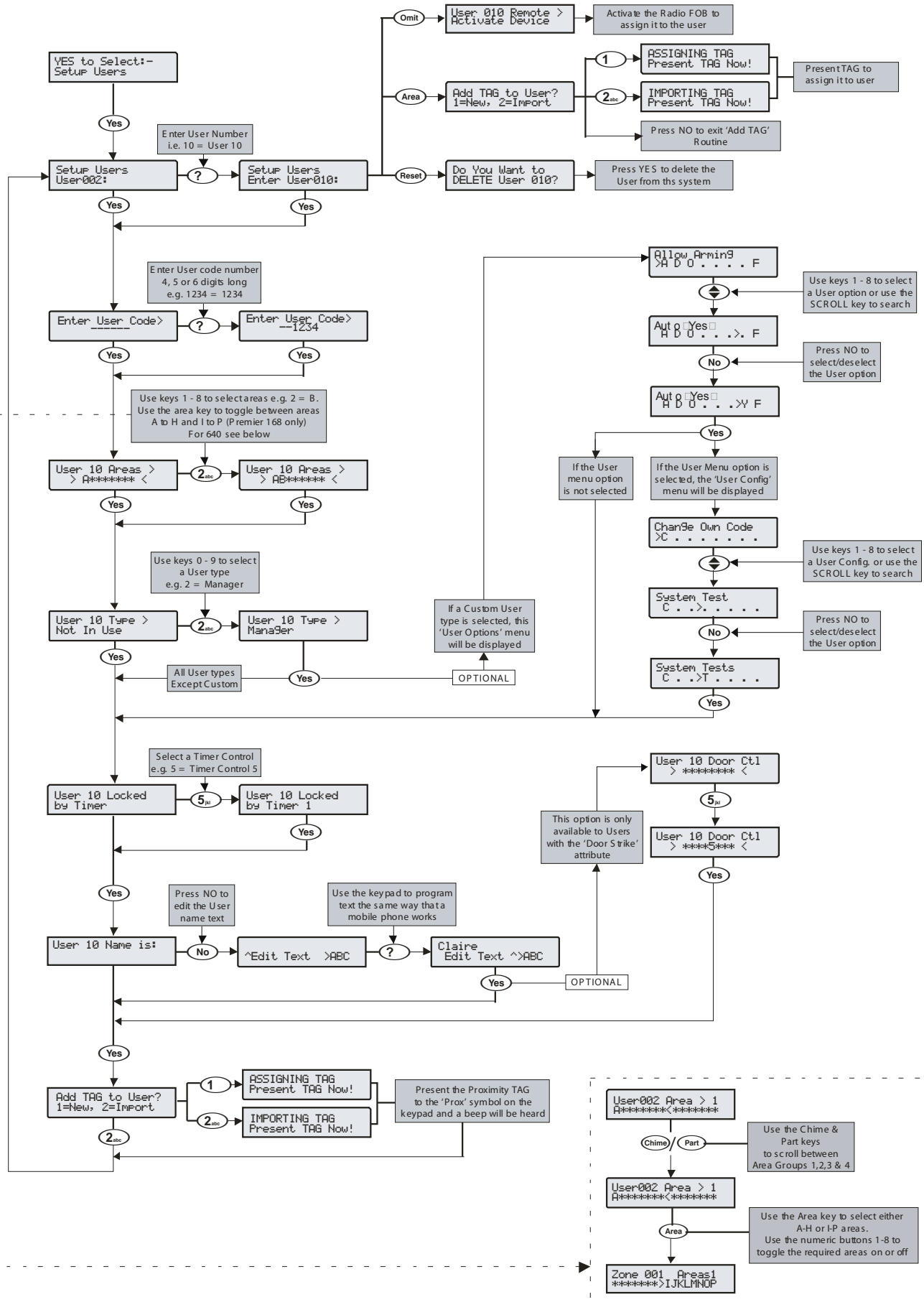

Default User Codes

When the control panel is first powered up and the factory default settings are loaded (see page 42 for details), only the Engineer code and the Master User code exist.

The Factory default Engineer User code is

1 2 3 4



The Engineer is always User 00.

If the Engineer code has been lost or forgotten, it can normally be reset back to the factory default without having to reprogram the entire system (see page 47 for details).

Resetting the Engineer code is only possible if the NVM has not been locked (see page 64 for details).

The Factory default Master User code is

5 6 7 8



The Master User is always User 01.

If the Master User code has been lost or forgotten, it can be reprogrammed by the Engineer in this menu.

Programming New Users

Each User code on the system is made up of the following elements. **Items 1, 2 or 8, 3 and 4** which are essential for the code to function correctly and **items 5, 6, 7, 8 and 9** which are optional.

1. User Number

When users are assigned to the system, they need to be identified by the control panel. Each user is identified as Users 01, 02, 03 etc. User 01 is always the Master User.

2. User Code

This is a unique 4, 5 or 6 digit code number that is assigned to a user. The system will allow a mixture of different length User codes. The User code must be entered at a keypad to operate the alarm system.



*There is a programmable 'Black List' of banned user codes which can be set and edited via **Wintex** UDL software.*

3. User Areas

Any number of areas can be assigned to the selected user. Assigning areas to a user determines which areas can be armed, disarmed, reset etc. by that user. In addition, assigning areas to a user determines which of the area related functions i.e. omitting zones, silent arming etc. will be available to that user.

4. User Types

The User type determines which functions are available to the user i.e. arming, disarming, resetting etc. In addition, the User type also determines which options the user can access i.e. Setup Users, System Tests etc.

5. User Time Lock

This option allows the selected user to be denied access to the system at different times of the day and days of the week. When a Control Timer is assigned to a user, the User code will not allow access to any functions during the timers 'On' period.

6. User Name Text

Each user can be assigned up to 8 characters of name text. The name text is displayed whenever a code is entered and also when reading the log, making identification of people using the alarm easier.

7. Door Control

This option would normally be used for access control. Users are able to open/unlock doors that are assigned to their user code.

8. Proximity TAG

As well as or instead of operating the alarm system with a code number, it is also possible to operate it by presenting a Proximity TAG to the keypad (this requires a Proximity keypad).

User Types

The User type determines which functions are available to the user i.e. arming, disarming etc. In addition, the User type also determines which options the user can access i.e. Setup Users etc. The following User types are available:

0: Engineer

Engineers can arm, disarm, omit zones, silence alarms and reset their assigned areas. In addition, Engineers can access the Programming Menu and all User menu options. Engineers can also change their own User codes and assign new users to the system.



The default Engineer User type (User 00) can assign any User types to the system.

Engineers can only disarm areas that were armed using an Engineer code. They cannot disarm any areas that were armed with another User code.

1: Master

Master users can arm, disarm, omit zones, silence alarms and reset their assigned areas. In addition, Master users can access all User menu options. Master users can also change their own User codes and assign new users to the system. The Master user will also activate any output programmed as 'Door Strike'.

2: Manager

Manager users can arm, disarm, omit zones, silence alarms and reset their assigned areas. In addition, Manager users can access all User menu options except Setup Users. Manager users can also change their own User codes.

3: Standard

Standard users can arm all the areas assigned to the code and disarm all the areas assigned to the code (even if only one area is in entry or alarm) from any keypad, omit zones, silence alarms and reset their assigned areas. In addition, Standard users can access all User menu options except for Setup Users, System Tests, and Change Timers. Standard users can also change their own User codes.

4: Local

Local users behave the same way as Standard users. However, Local users will only arm the area that the keypad is assigned to and disarm the area that is in entry or alarm (provided that the code has that area assigned to it)

5: Duress

Duress users behave the same way as Standard users. However, Duress users will activate any outputs programmed as 'Panic Alarm' or 'Duress' whenever their code is entered.



Duress users can only be set up by an Engineer if system is set to Grade 3 – see configuration option 37.

6: Arm Only

Arm Only users can only arm or reset their assigned areas and view the event log.

7: Door Strike

Door Strike users have no access to User functions or Menu options. However, Door Strike users will activate any outputs programmed as 'Door Strike' whenever their code is entered (see page 80 for details).

8: Vacation

Vacation users behave the same way as Standard users. However, Vacation users will automatically be deleted the first time that the Master User code (User 01) is used to disarm the system.



Vacation user can only be deleted by the Master user after it has been used to disarm the system at least once.

9: Custom

Custom users can access any functions and User menu options that have been assigned to them in 'User Options 1 or 2' and 'User Config'. This flexibility allows new User types to be created that have their own unique set of characteristics. Any number of Custom users can be assigned to the system and each one will respond differently, depending on the functions and features that have been assigned to them.

User Functions and Options

The table below shows the options that are available to each user.



All users that have access to the 'Arming Menu' have the ability to 'View Zone Status', 'Set Chime Areas', 'View Act. Faults' and 'View Act. Counts'.

All users have access to the 'User Menu' have the ability to 'View Event Log', 'Adjust Volumes' and 'Print Event Log'.





User Options 1									
Engineer	Master	Manager	Standard	Local	Duress	Arm Only	Door Strike	Vacation	Custom
Arming	Arming	Arming	Arming	Arming	Arming	Arming	-	Arming	-
Disarming	Disarming	Disarming	Disarming	Disarming	Disarming	-	-	Disarming	-
Omitting	Omitting	Omitting	Omitting	Omitting	Omitting	-	-	Omitting	-
Eng. Reset	-	-	-	-	-	-	-	-	-
-	-	-	-	Local Arming	-	-	-	-	-
-	-	-	-	Local Disarm	-	-	-	-	-
-	-	-	-	-	-	-	-	-	-
Disarm First	Disarm First	Disarm First	Disarm First	Disarm First	Disarm First	-	-	Disarm First	-

User Options 2									
User Menu	User Menu	User Menu	User Menu	User Menu	-	User Menu	-	User Menu	-
Eng. Program	-	-	-	-	-	-	-	-	-
-	-	-	-	-	-	-	-	-	-
-	-	-	-	-	-	-	-	Vacation	-
Door Strike	Door Strike	-	-	-	-	-	Door Strike	-	-
Call Rem. PC	Call Rem. PC	Call Rem. PC	-	-	-	-	-	-	-
-	-	-	-	-	Duress Code	-	-	-	-
Open/Close	Open/Close	Open/Close	Open/Close	Open/Close	Open/Close	Open/Close	-	Open/Close	-

User Config.									
Engineer	Master	Manager	Standard	Local	Duress	Arm Only	Door Strike	Vacation	Not Used
Change Code	Change Code	Change Code	Change Code	Change Code	-	-	-	-	-
Chime Zones	Chime Zones	Chime Zones	Chime Zones	Chime Zones	-	-	-	-	-
Change Timer	Change Timer	Change Timer	-	-	-	-	-	-	-
System Tests	System Tests	System Tests	-	-	-	-	-	-	-
Setup Users	Setup Users	-	-	-	-	-	-	-	-
Eng. Access	Eng. Access	Eng. Access	Eng. Access	Eng. Access	-	Eng. Access	-	Eng. Access	-
Add Eng. code	-	-	-	-	-	-	-	-	-
NVM Locking	-	-	-	-	-	-	-	-	-

User Options 1

This menu defines which options are available to the user when their code is entered.

Press  to scroll through the options and press  to select them or use keys  -  ('Letter' = option **IS** selected, 'Star' = option is **NOT** selected).

The following options are available:

A - Arming

Areas assigned to the selected user can be armed.

D - Disarming

Areas assigned to the selected user can be disarmed.

O - Omitting

Zones assigned to the same areas as the selected user can be omitted, providing that they have the 'omit' attribute assigned to them.

R - Eng. Reset (Engineers only)

Areas programmed as 'Engineer reset' can be reset after an Alarm has occurred.

a - Local Arming

The User can only arm areas that the keypad is assigned to.

d - Local Disarm

The User can only disarm areas that the keypad is assigned to, or areas that are in entry or alarm (provided that the code has that area assigned to it).

Y - Auto 'YES'

After a User code has been entered, pressing the  key to confirm the next action is not required.





F - Disarm First

If an area is already armed and the selected user enters their code, the 'Disarm' option is displayed.

User Options 2

This menu is only displayed if the Custom User type is selected (see page 109 for details).

This menu defines which options are available to the user when their code is entered.

Press  to scroll through the options and press  to select them or use keys  -  ('Letter' = option **IS** selected, 'Star' = option is **NOT** selected).

The following options are available:

U - User Menu

The selected user has access to the User menu. However, the selected user will only have access to options assigned in 'User Config.' (see page 110 for details).

E - Eng. Program (Engineers only)

Only Available to Engineers.

D - Dual Code

The selected user can only access an area when a second User code (with the 'Dual Code' attribute and also assigned to the same area) is entered. Dual Code users will also activate the '1st and 2nd Code' output type.

V - Vacation

The selected user is enabled the first time it is used to disarm the system and can be used as many times as required. However, it will be automatically deleted the first time that the User 01 code is used to disarm. Vacation users will only be deleted by the Master user, once they have been used on the system.

S - Door Strike

The selected user will activate any outputs programmed as 'Door Strike', whenever their codes are entered.

R - Call Rem. PC

The selected user has access to the 'Call Remote PC' option, allowing them to initiate a call to a remote upload/download PC.

C - Duress Code

The selected user will activate any outputs programmed as 'Duress', whenever their codes are entered.





O - Open/Close

The selected user will report open (disarm) and close (arm) events to an Alarm Receiving Centre every time they arm or disarm.

User Config.

This menu will only be displayed if a Custom User type is selected AND 'User Menu' (**User Option: U**) is enabled (see page 110 for details).

This menu defines which menu options are available to the user when their code is entered.

Press  to scroll through the options and press  to select them or use keys  -  ('Letter' = option **IS** selected, 'Star' = option is **NOT** selected).

The following options are available:

C - Change Code

The selected user can change their own User code.

Z - Chime Zones

The selected user can access the 'Edit Chime Zones' option, allowing them to select which zones chime when activated.

T - Change Timers

The selected user can access the 'Override Timers', 'Alter Timers', 'Alter Part Arms', 'Alter Hol. Dates' and 'Edit Phone No.' menu options.

S - System Tests

The selected user can access the 'System Tests' option, allowing them to walk test zones, activate the external sounder etc..

U - Setup Users

The selected user can access the 'Setup Users' option, allowing them to alter existing users or assign new users. However, users cannot assign User types to the system that have a higher access level than themselves. Also, if a user assigns a Custom User type, functions that are not available to them cannot be assigned to the Custom user.

E - Eng. Access

The selected user can access the 'Enable Engineer' option, allowing them to authorise Engineer access or Remote UDL access to the system.

A - Add Eng. Code (Engineers only)

Only Available to Engineers.

N - NVM Locking (Engineers only)

Only Available to Engineers.

User Time Lock

This option allows the selected user to be denied access to the system at different times of the day and days of the week. When a Control Timer is assigned to a user, the User code will not allow access to any functions during the timer 'On' period (see page 68 for timer programming).

The first 4 options (48) or 6 options (88/168) will lockout the selected user (Code and TAG) when the corresponding control timer is active. The last two options will lock out the selected users TAG (T) when Custom Output 2 Stage A is active or lock out the selected users Code (C) when Custom Output 2 Stage B is active.

This allows conditions to be set up in the custom outputs and then the TAG or Code to be locked out during those conditions i.e. Custom Output 2 Stage B could be programmed to activate during entry, resulting in the code being disabled during the entry period.

User Name Text

Each user can be assigned up to 8 characters of name text. This can be beneficial when reading the log, as identification of people is made easier.

See page 47 for details on programming text.

Text is programmed in a similar way to mobile phones. Select characters by pressing the corresponding key the appropriate number of times (to select a character on the same key, press the

key to move the cursor along).

Door Control

This option would normally be used for access control as it only allows the user to open/unlock doors that are assigned to that user code.

NOTE Door control is only available to users with the 'Door Strike' attribute assigned to it.

Adding Tags

When using a Proximity Keypad, Tags can be programmed or imported from another panel.

When prompted, select 1 to add new Tag or 2 to import a Tag from another system.

Tags can be imported from any other panel to any user and it is possible to import Tags from several other panels.

Deleting Users

If a User code needs to be deleted from the system, this must be done, by a user that has access to the 'Setup Users' menu.

To delete User codes proceed as follows:

Ensure that Setup Users is selected, the display should look like this:



Press **(Yes)**, the display should look like this:



Select a user from 1 to 24 (48), 1 to 49 (88) or 1 to 199 (168)

(?) (?) then press **(Yes)**, the display should look like this:



Press **(Reset)**, the display will look something like this:



Where '15' is the selected User number.

Press **(Yes)** to confirm deletion of the selected User code

Press **(Menu)** to exit from Setup Users

Adding SmartKey™

Introduction

Premier Elite SmartKey™ are now learnt and all functionality managed through the "Setup Users" Menu.

Ricochet™ MT2 and Premier Elite Series V2 firmware upgrades add additional capabilities to the management of Premier Elite SmartKey™. In multiple expander systems it is now possible to

choose which zones (and therefore expander) the Premier Elite SmartKey™ will use for its routing, LED and Aux functions can also be changed within the "Setup Users" menu.

All users on the system can have a Premier Elite SmartKey™ a TAG and a code, or any combination of them.

This section only deals with Premier Elite SmartKey™ learning and routing, all other user programmable options can be found in INS176-8 Premier Elite Series Installation Manual or later.

NOTE Great care should be taken when using large numbers of Premier Elite SmartKey™, only one Premier Elite SmartKey™ per expander can be used by the system at any one time, and on Multiple expanders systems, or large sites, functionality should be checked in all areas of the site where the device may be used.

Premier Elite SmartKey™ Routing

Premier Elite SmartKey™ should only be learned to the system AFTER all devices have been learned and placed in their final location. Whilst it is possible to learn at any point during the programming of the system, learning and testing the functionality of the Premier Elite SmartKey™ after all devices have been placed will ensure that the Premier Elite SmartKey™ performs as expected, and works in locations where the user would expect it too.

Route By

The Route By function allows you to select which Zones (and therefore expander) the Premier Elite SmartKey™ will use on the system for its routing. This should be selected BEFORE the device has been learned.

In the examples below Fig 1 shows the zones associated with Expander 1, which is a 32XP-W, and Fig 2 shows Expander 2 which is also a 32XP-W, when using 8XP-W there will obviously be less devices that the Premier Elite SmartKey™ can use.

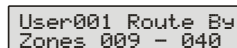

Fig 1

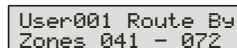

Fig 2

The **(Area)** key is used to select this menu and the **(arrow)** key used to select which expander and associated zones will be used

Once a Premier Elite SmartKey™ has been learned the **(Area)** key will show which zones are being used for routing. It is not possible to alter this once learned. To change the routing the Premier Elite SmartKey™ should be deleted and the process started from the beginning.

Deleting a Premier Elite SmartKey™

Deleting the Premier Elite SmartKey™ from the user is a similar process to learning, at the appropriate point in the menu press **(Menu)** followed by **(Area)**, the Premier Elite SmartKey™ will be removed from the User. To delete all user data see INS176-8 or later.

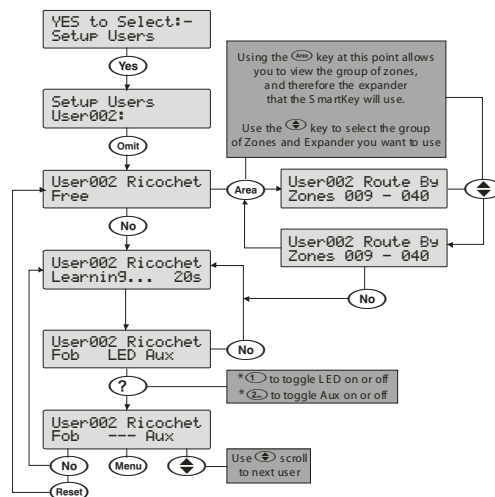

5.9 Engineer Utilities

View Event Log

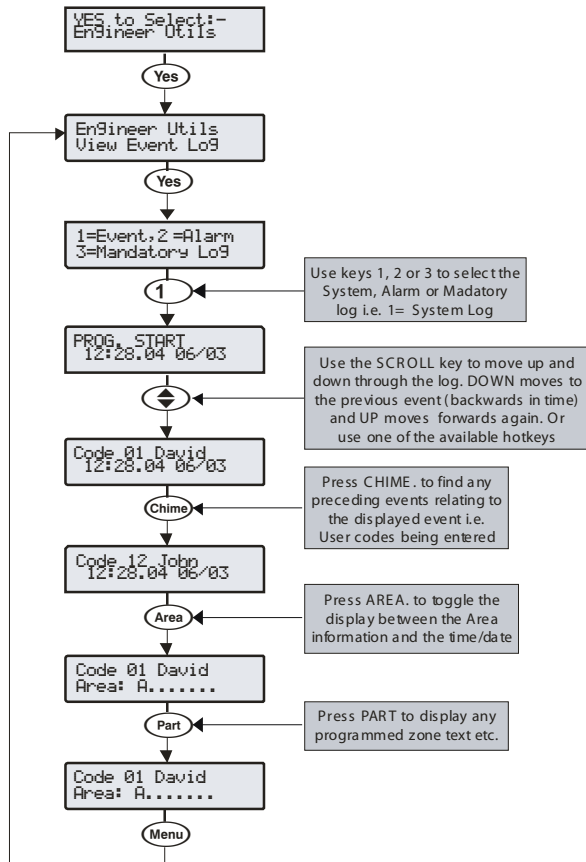

The control panel has three Event Logs, which are time and date stamped. The first log which is a system log, records all events that occur on the system, i.e. Users entering their codes to arm or disarm areas, alarm events, failures to arm etc.

The second log which is an alarm log, only records alarm events that occur on the system.

The third log is the Mandatory Event log which records only events defined as 'mandatory' by **EN50131**.

The **System Log** records the last 500 (48), 1000 (88) or 2000 (168) events.

The **Alarm Log** records the last 32 alarm events.

The **Mandatory Log** records the last 500 mandatory events.

Event Log Hotkeys

When viewing the system log there are 9 hotkeys available. These hotkeys allow certain events to be found easier without the need for searching.

The following hotkeys are available:

- ① = Priority Alarms (PA, Fire etc.)
- ②_{abc} = Normal Alarms (Guard, 24hr, Entry/Exit etc.)
- ③_{def} = Opens and Closings (Arm, Disarm etc.)
- ④_{ghi} = Omits and Reinstates (Zone Omits etc.)
- ⑤_{kl} = Maintenance (System Tests, Engineer Program etc.)
- ⑥_{mno} = Tamperers (Zone, Bell, Aux etc.)
- ⑦_{pqr} = Test Calls (Communicator Active, successful etc.)
- ⑧_{tuv} = Entry/Exit (Entry and Exit Procedures)
- ⑨_{wxy} = User Codes (User codes being used)

Event Log Descriptions

Log Event	Description
### ARM FAILED	An exit fault from Zone ### has caused the system to fail to arm
### Fit Alarm	Zone ### has detected a Fault condition
### Mask Alarm	Zone ### has detected a Mask condition
### Test Failed	Zone ### has activated whilst it has been on soak test
### Tested OK	Zone ### has activated during the walk test
## RESET AREAS -	Area have been reset using keypad #,# following an Intruder alarm
AC Off Alarm	The control panel has detected an AC Mains failure
ALARM ABORT	An Open After Alarm-Abort has occurred for area ?
ALARM Active	An Intruder alarm signal has been activated for area ?
Anti-Code Reset	A reset has been performed using the Anti-code reset procedure
AREA Armed	Area ? has been armed
AREA Disarmed	Area ? has been disarmed
ARMED WITH L/F	The system has been armed with a Line Fault condition present
ARMING FAILED	A Exit Error-Arm Fail has occurred on area ?
ARMING SUITE #	Area Arm Suite # was used to arm the system
ATS FAILED	The Communicator has failed to report to the Alarm Receiving Centre
ATS FLT Alarm	There is a problem with the telephone line
AUTO TEST CALL	An Automatic test call has been initiated
AUX #,# Tamper	An Auxiliary Tamper input from device #,# has been activated
AV CLEARED by ##	The Audio Verification unit has been cleared down by user ##
BELL #,# Tamper	A Bell Tamper input from device #,# has been activated
BELL Active	The Bell output has been activated for area ?
BELL FUSE Alarm	The control panel Bell Fuse has failed
BOX LID Tamper	The control panel lid has been removed causing a Tamper alarm
CHARGER FAULT	Battery Charge Current has Failed
CIE Reset	The internal processor has failed its self checks.
CODE #,# Tamper	Too many invalid key presses have caused a tamper alarm from keypad #,#
Com??? Line Fault	The Com300, 2400 or ISDN has detected a line fault
COM PORT Alarm	A com port has generated an alarm
CONFIRMED ALARM	Two or more detectors have activated, resulting in a confirmed alarm condition
CONFIRMED PA	Two or more PA zones have activated, resulting in a confirmed PA alarm condition
CONFIRMED INTRUDER	Two or more detectors have activated, resulting in a confirmed Intruder condition
CORRUPT EVENT	No event has been stored in memory
CROSS ### Alarm	A Verified Cross Zone (Beam Pair) Alarm has occurred from zone ###
DATA CHANGED	Programming data has been changed
DATE CHANGED	The control panel Time has been changed
DEFAULTS LOADED	The factory default values have been loaded into memory
DEFERRED	The arming mode was deferred for area ?
DOOR #,#	Door #,# has been opened by a user with Door Control
DOWNLOAD START	An Upload/Download has been initiated
DOWNLOAD END	The Upload/Download has finished
DURESS	User ## has entered a Duress Code at a keypad
Engineer Reset	A reset has been performed using an Engineers code
ENTRY Area ##	The Entry mode has been started for area ?
EXIT Area ##	The Exit mode has been started for area ?
EXP #,# Reset	A reset has been performed using the input on expander #,# (programmed as reset)
EXP #,# Line Fault	The Input on expander #,# (programmed as line fault) has been activated
EXP #,# LOST	Expander ## has been lost from the network
EXP #,# Tamper	The cover of expander #,# has been removed
EXP ## Low Voltage	Expander #,# has detected that its supply voltage is low
F_PA ##	A Panic Alarm from a Radio FOB has been generated
Fault Override	The system has been armed with a Fault condition present by a user
FIRE ### Active	Zone ### (programmed as Fire Alarm) has caused an alarm
FIRE ### Tamper	Zone ### (programmed as Fire Alarm) has caused an Tamper alarm
FIRST KNOCK ###	Zone ### (which is programmed as double knock) has activated for the first time
FUSE #,# Alarm	The Auxiliary 12V Fuse in device #,# has failed
GSM MODULE LOST	The GSM Module has lost communications with the control panel
iD Loop# Tamper	There is a short circuit on iD loop # on the iD expander
Key switch Reset	A reset has been performed using a key switch
KSW ### Disarmed	A Keyswitch zone type has been activated (zone number ###)
LOG ALERT	80% of the Event Log has filled (since the last Upload/Download)
LOG CLEARED	The event log has been erased
LOW BAT Alarm	The control panel has registered a low battery condition
LOW V #,# Alarm	Expander #,# has detected that its supply voltage is low
MANUAL TEST CALL	A Manual test call has been initiated
MIC ## TESTED	Microphone ## on the Audio Verification Module has been tested
Monitored Alarm	A zone programmed as key tube has caused an alarm
No RF Signal ###	The Wireless receiver has detected a signal loss from zone ###
PA From Remote FOB	A PA has been generated from a Remote Fob
Panel Line Fault	The control panel line fault input has been activated
PART Armed	Area ? has been Part Armed
PART 1 Armed	Part Arm 1 has been selected
PART 2 Armed	Part Arm 2 has been selected
PART 3 Armed	Part Arm 3 has been selected
POWERED UP	System Power Up (without doing a factory restart)
POWER O/P FAULT	The system has generated a Power Output Fault see Table Power ID Fault on Page 98
POWER UNIT FAILURE	The system has generated a rate of voltage failure
PROG. END	The Engineer has logged out of the Programming menu
PROG. START	An Engineer code has been entered
PSUac ## Alarm	An expander input programmed as PSU Monitor control panel has detected an AC Mains failure
PSUbat## Alarm	An expander input programmed as PSU Monitor control panel has detected a Battery fault
PSUvol## Alarm	An expander input programmed as PSU Monitor control panel has detected a 12V Output failure

Log Event	Description
PSUTam## Alarm	An expander input programmed as PSU Monitor control panel has detected a Tamper condition
QUICK Armed	Quick Arm from keypad #,#
R/Bat ## Alarm	The Wireless receiver has detected a low battery signal from device ##
Radio Jamming	The Wireless receiver has detected an attempt to jam its radio signal
RADIO PAD LOST	The Radio-Pad has no signal or has lost communications with the control panel
REARM LOCK ###	Zone ### has locked out after reaching its re-arm limit (after causing an alarm)
RECENT Armed	Area ? has been armed recently
Redcare Line Fault	The Redcare has detected a line fault
REMOTE Armed	Area ? was armed using the Wintex UDL software
REMOTE Disarmed	Area ? was disarmed using the Wintex UDL software
Remote PC Reset	A reset has been performed by the remote download PC
Remote Reset	A reset has been performed using the 'Remote Reset' input
Redcare Reset	A reset has been performed by the Redcare
RF Device ###Low Battery	RF Device ### has registered a low battery condition
RKP #,# MEDICAL	A Medical alarm (7 & 9) has occurred from keypad number #,#
RKP #,# FIRE	A Fire alarm (4 & 6) has occurred from keypad number #,#
RKP #,# AUD PA	An Audible PA alarm (1 & 3) has occurred from keypad number #,#
RKP #,# SIL PA	A Silent PA alarm (1 & 3) has occurred from keypad number #,#
RKP #,# Tamper	The cover of keypad #,# has been removed
RKP #,# LOST	Keypad ## has been lost from the network
RKP LOCKED #,#	Keypad #,# has been locked out from too many invalid key presses
Site Data Changed	Site Data has been changed e.g. zone ### has been changed
Supervision Fault	A Radio device has failed to poll back to the panel within the Supervision Time
System Over Voltage	The control panel Bell Fuse has failed
TAG ##	User ## has presented their Prox TAG
Test Call Passed	Manual or Periodical Test Call has passed
Test Call Failed	Manual or Periodical Test Call has failed
TESTED ###	Zone ### has been tested
TEST FAIL ###)	Zone ### has failed its Soak test
TAG System Exit (Batt. OK)	The system has been put in to exit via tag and battery voltage is ok
TAG System Exit (Batt. Low)	The system has been put in to exit via tag and battery has low voltage
TAG System Entry (Batt. OK)	The system has been put in to entry via tag and battery voltage is ok
TAG System Entry (Batt. Low)	The system has been put in to entry via tag and battery has low voltage
TIME Armed	Area ? was armed automatically using one of the control timers
TIME CHANGED	The control panel Date has been changed
TIME Disarmed	Area ? was disarmed automatically using one of the control timers
TUBE ### Alarm	Zone ### (programmed as Key Tube) has caused an alarm
USER ##	User ## has entered their code
User Ack	A user has acknowledged a fault to set system
USER CODE CHANGED	A User code has been altered
USER ADDED	A User code has been added
USER DELETED	A User code has been deleted
User Reset	A reset has been performed using a User code
WALK Test Start	The Walk Test mode has been initiated
Zone ### Alarm	Zone ### has been activated
Zone ### Tamper	Zone ### has caused a Tamper alarm
Zone ### Restore	Zone ### has restored to its normal condition
Zone ### Omitted	Zone ### has been omitted
Zone ### Un-Omit	Zone ### has been reinstated
Zone ### Test Start	Zone ### has been put on test
Zone ### Test End	Zone ### has been removed from test
Zone ### Fault	Zone ### has generated a Fault Condition
Zone ### Masked	Zone ### has been Masked

Do Bell Test

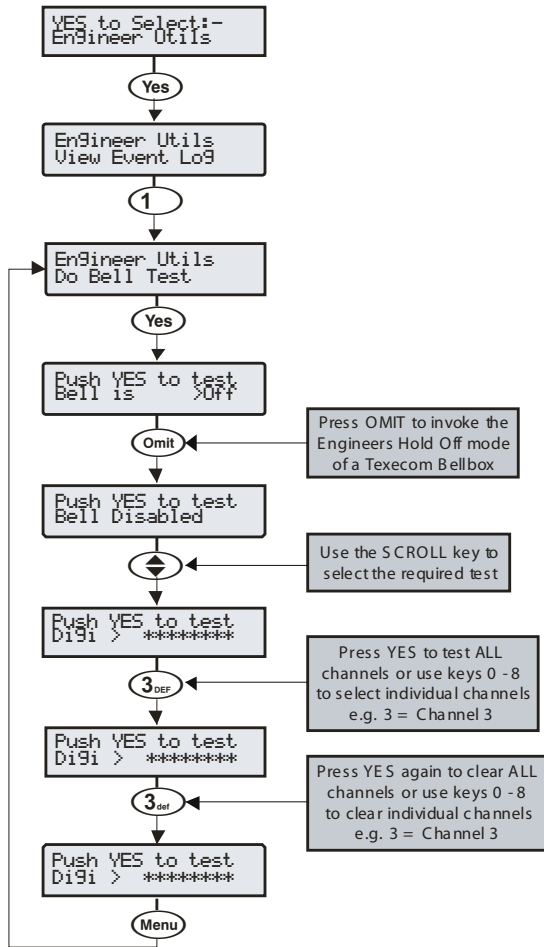

This option allows the Bell, Speaker and various control panel outputs to be tested.

The following outputs can be individually tested:

- Test Bell** The Bell output
- Test Strobe** The Strobe output
- Test Speaker** The Speaker output
- Test Digi** The Hardwired digicom outputs
- Test Panel** The panel outputs
- Test RedCARE** The plug on RedCARE outputs
- Test Com????** The plug on Com 300/2400 digi channels
- LCD Display** The LCD keypad display
- User Outputs** Any outputs that have the 'User Test' attribute (see page 81 for details).

NOTE Pressing OMIT at the Bell or Strobe Test will cause the Strobe output to pulse 3 times, invoking Engineers Hold Off mode if a Texcom bell box is connected.

Do Walk Test 24/48/88/168

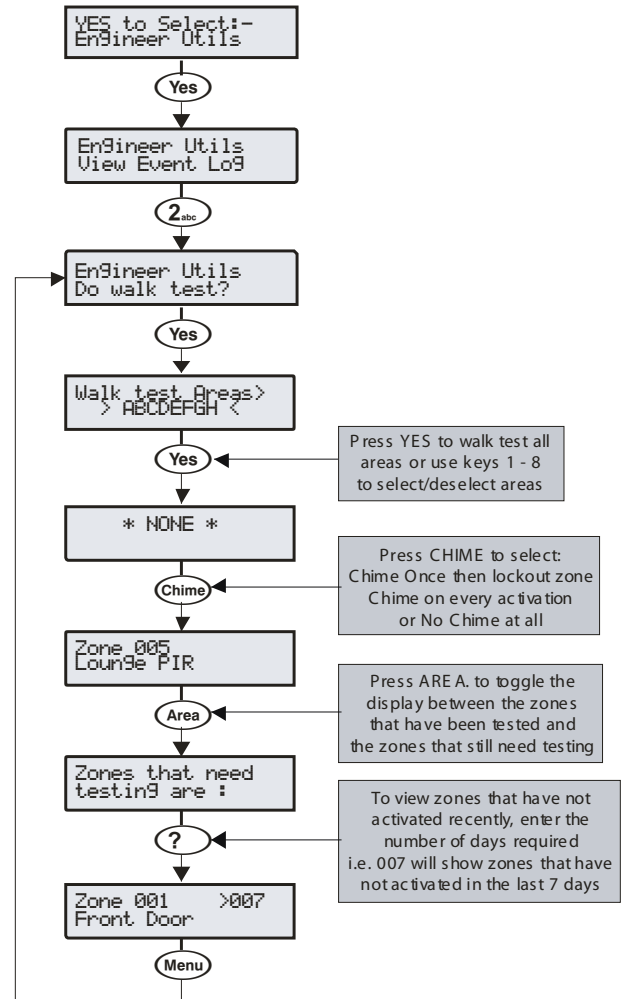

Any of the zones on the system can be walk tested to ensure that they operate correctly. A walk test can only be performed when the system or area is disarmed.

NOTE Once a zone has been activated it will not generate a chime tone again. If however the **Chime** key is pressed, a zone will chime every time it is activated.

The Walk test menu also includes a last activation log that can be recalled when doing a walk test. This log shows zones that have NOT been activated over a period of days.

Pressing the **Area** key will firstly show the zones that still need testing, pressing the **Area** key a second time will display the zones that have not been activated that day, to view zones that have not been activated for 3 days, type in 003 the maximum number of days that can be recalled is 255, pressing the **Area** key a third time will revert back to the standard walk test display.

Do Walk Test 640

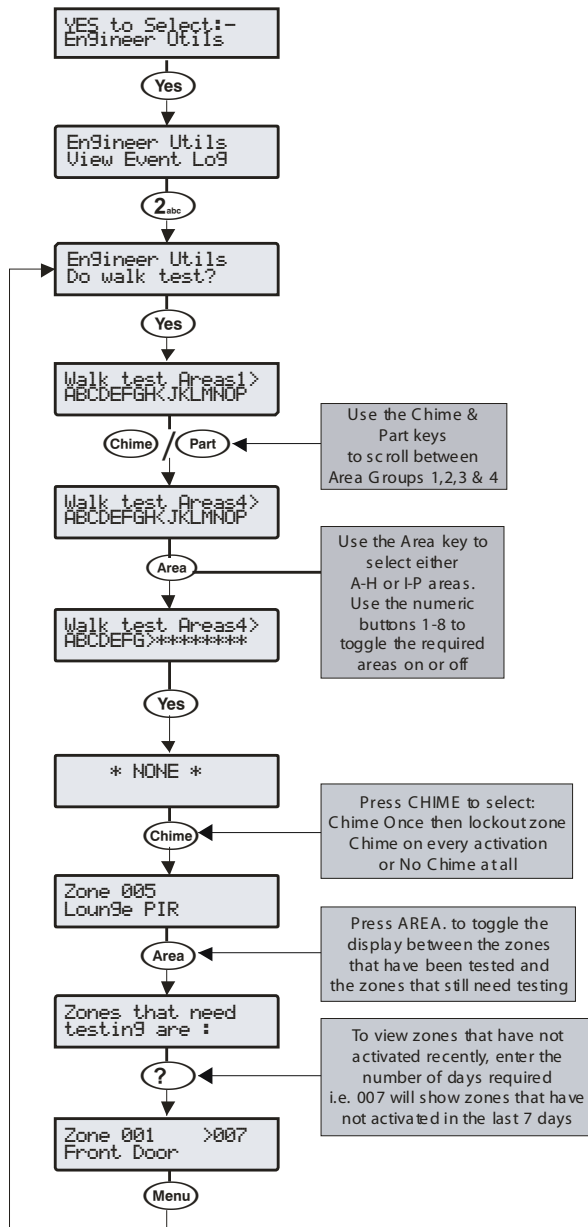

Any of the zones on the system can be walk tested to ensure that they operate correctly. A walk test can only be performed when the system or area is disarmed.

NOTE Once a zone has been activated it will not generate a chime tone again. If however the **Chime** key is pressed, a zone will chime every time it is activated.

The Walk test menu also includes a last activation log that can be recalled when doing a walk test. This log shows zones that have NOT been activated over a period of days.

Pressing the **Area** key will firstly show the zones that still need testing, pressing the **Area** key a second time will display the zones that have not been activated that day, to view zones that have not been activated for 3 days, type in 003 the maximum number of days that can be recalled is 255, pressing the **Area** key a third time will revert back to the standard walk test display.

View Zone Status

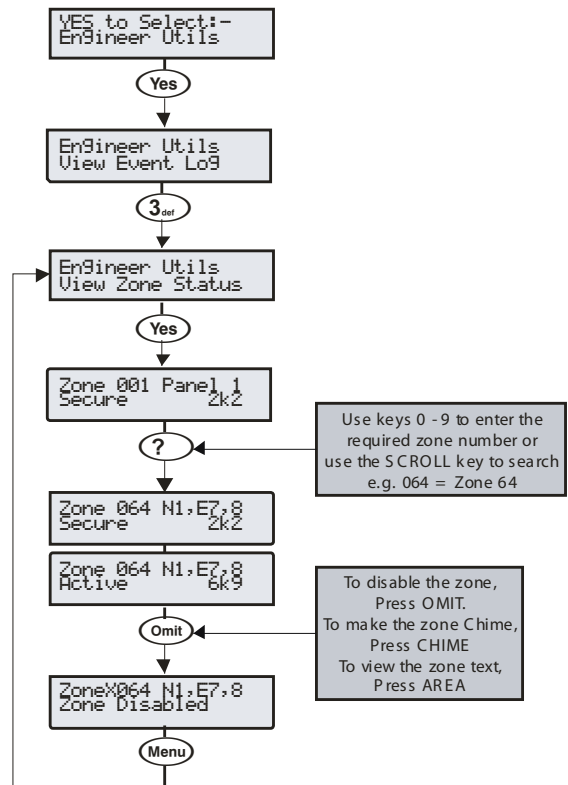

This option can be used to view the status of any zone on the system to see whether it is 'Active', 'Secure', 'Tampered' or 'Shorted'. The selected zone can also be temporarily disabled (zone and tamper) to allow the zone to be worked on or made to chime every time it is activated.

NOTE When leaving the View Zone Status menu, all zones will be automatically reinstated and cleared of Chime.

Do System Tests

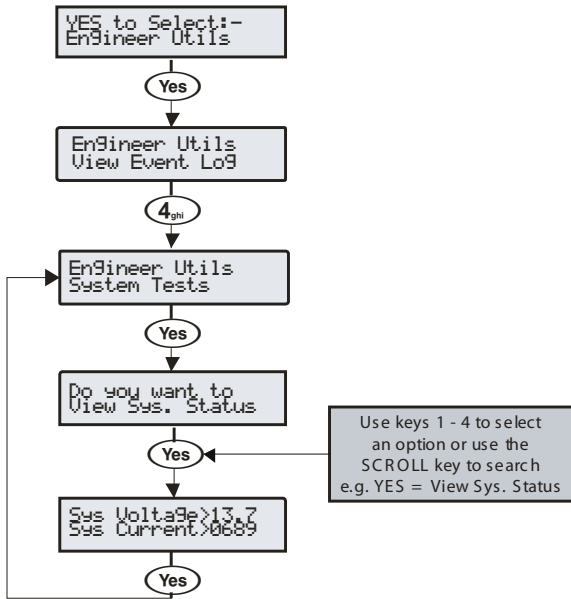

This option allows various control panel features to be tested or reviewed.

1 - View Sys. Status

Allows the system voltage and current to be viewed.

2 - View Batt Status

Allows the battery voltage and charging status to be viewed.

3 - Test Outputs

Allows the Bell, Speaker and system outputs to be tested.

4 - View Version No.

This option allows the control panel software version and serial number to be viewed.

Confirm Devices

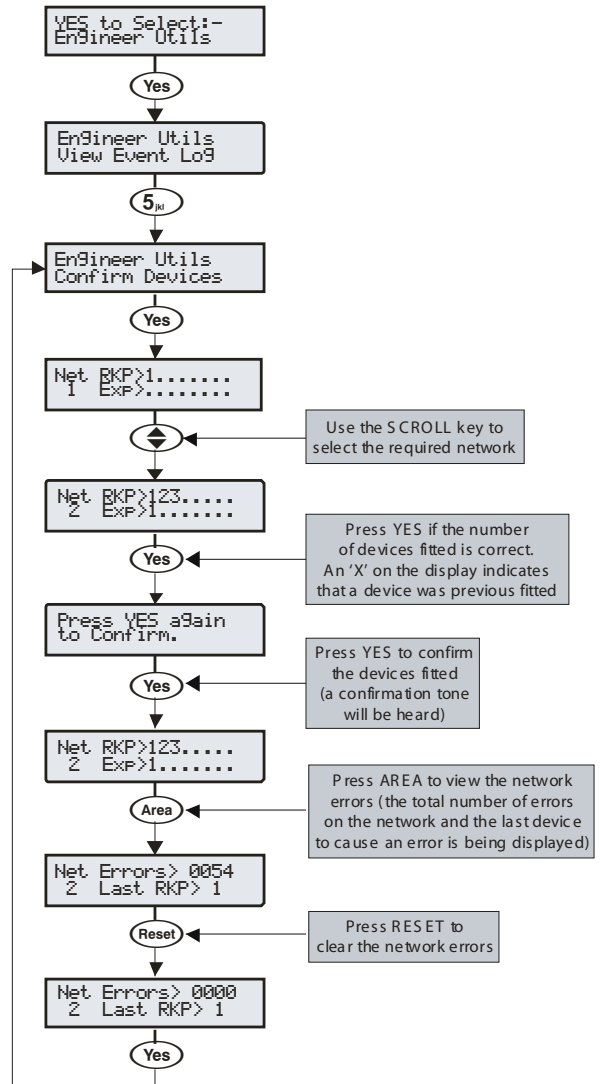

This option allows the networks to be viewed to see what devices are connected and whether there are any problems. Whenever new devices are added to the system, the networks must be checked and confirmed.



If any devices are removed from the system, the networks must be rechecked and reconfirmed.

An 'X' on the display indicates that device that was previous fitted is no longer being seen by the control panel.

View RKP Status

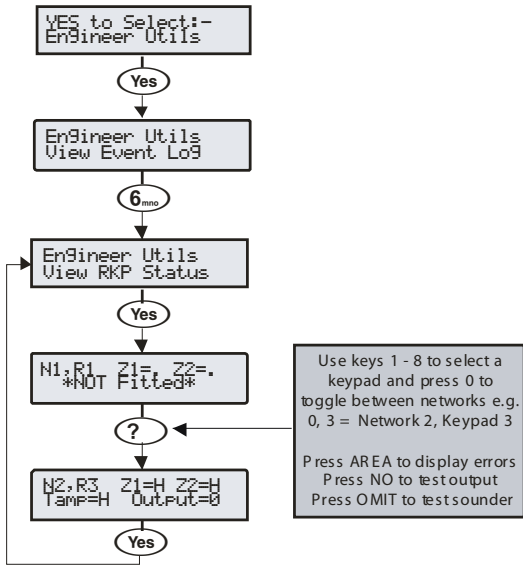

This option allows the status of the keypad, the zones and the output to be viewed.

View Exp. Status

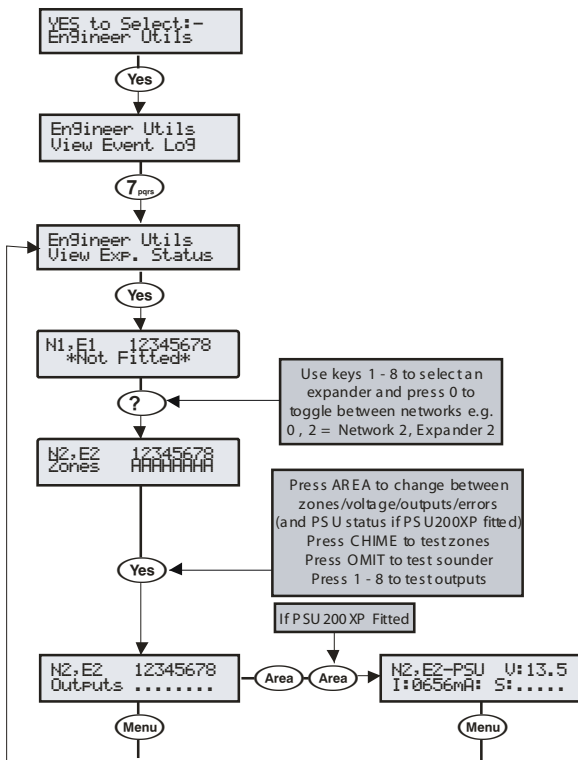

This option allows the status of the expander, the zones, voltage/inputs and outputs and any monitored power supply to be viewed.

NOTE The PSU status shows the following codes:.

- A: AC Mains Fail
- 1: Battery 1 Fault
- 2: Battery 2 Fault
- F: Mains Fuse Blown
- T: PSU Box Tamper

Set System Time

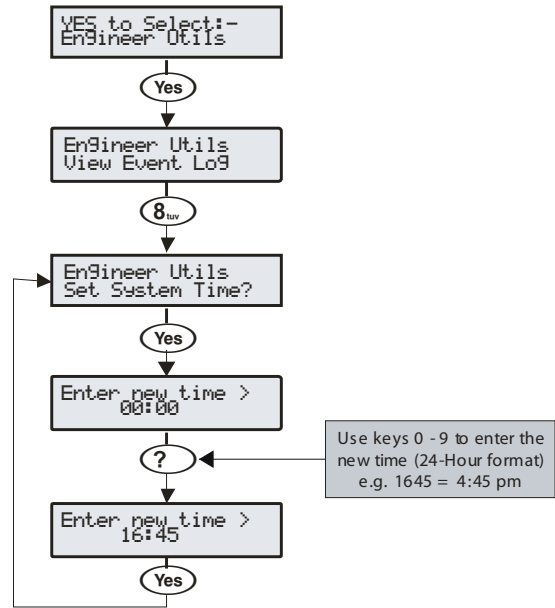

The control panel has a real time clock that is used to date and time stamp events that are recorded within the system log. The option allows you to set the control panel time.

Set System Date

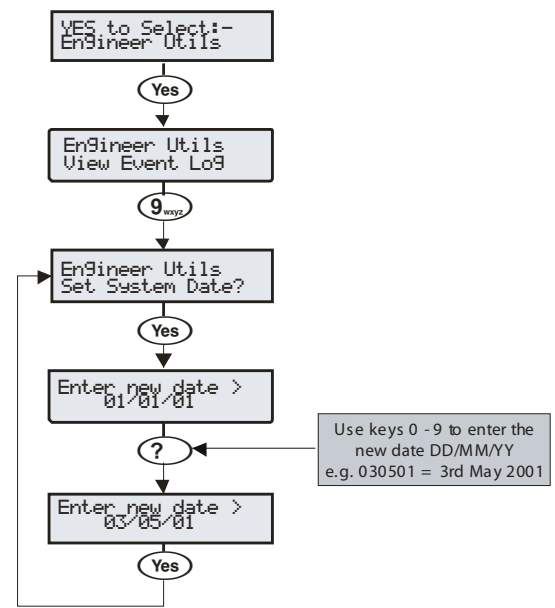

The control panel has a real time clock that is used to date and time stamp events that are recorded within the system log. The option allows you to set the control panel date.

Change Eng. Code

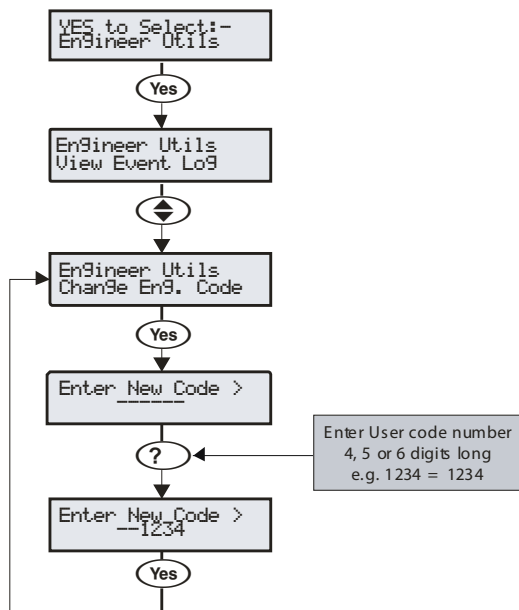

This option allows the Engineer code (User 00) to be changed. This code can be 4, 5 or 6 digits in length. The system will allow a mixture of different length User codes.

Default NVM Data

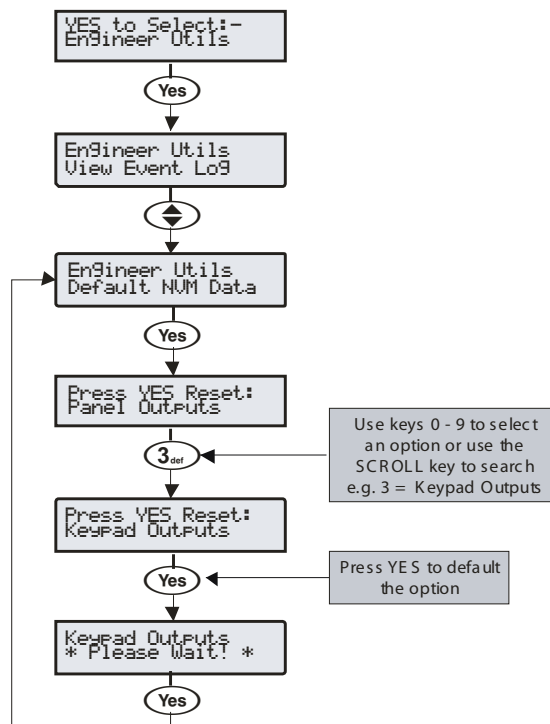

This option allows various parts of the NVM to be defaulted without having to 'Factory Default' the system.

Adjust Volumes

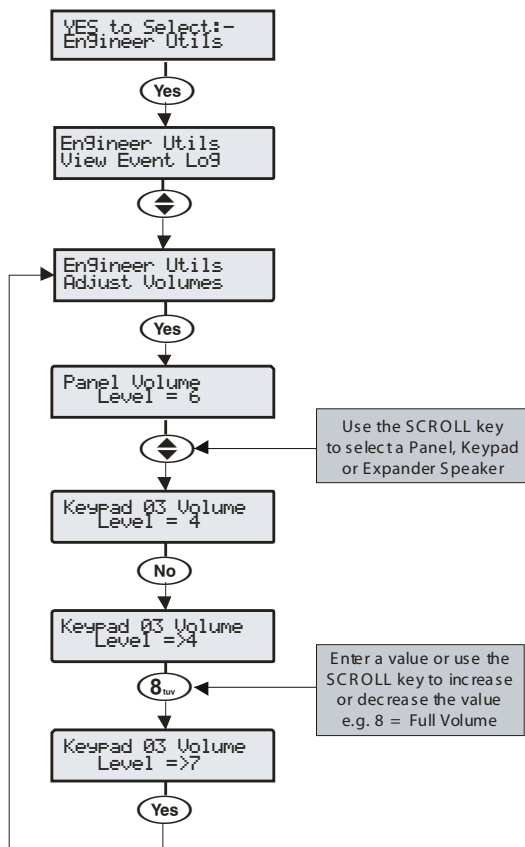

This option is used to adjust the volume level of speakers that are connected to the control panel, keypads and expanders.

NOTE Pressing the **CHIME** key will cause the speaker that is being programmed to generate the exit tone at the selected volume level.

Location Text

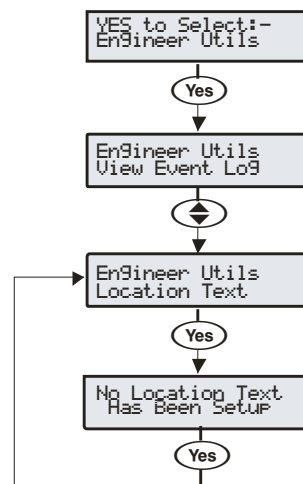

This option allows the 'Panel Location' text that has been programmed in 'System Text' to be displayed (see page 69 for programming details).

NOTE The display will automatically clear after 5 seconds.

Print Log Data

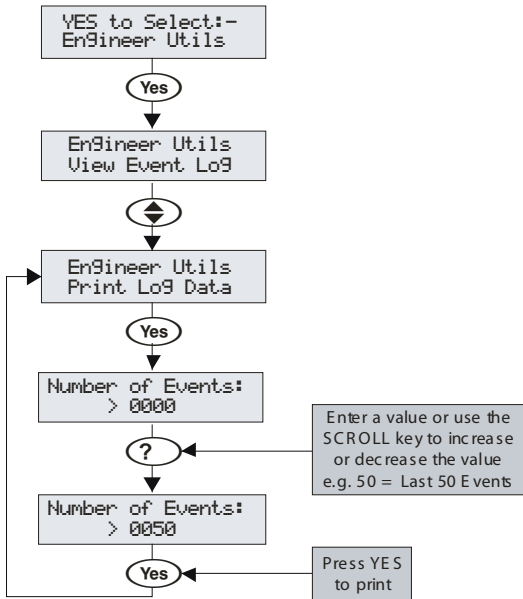

This option allows the 'Event Log' to be printed to a standard RS232 printer (see page 41 for details).

Soak Test Areas 640

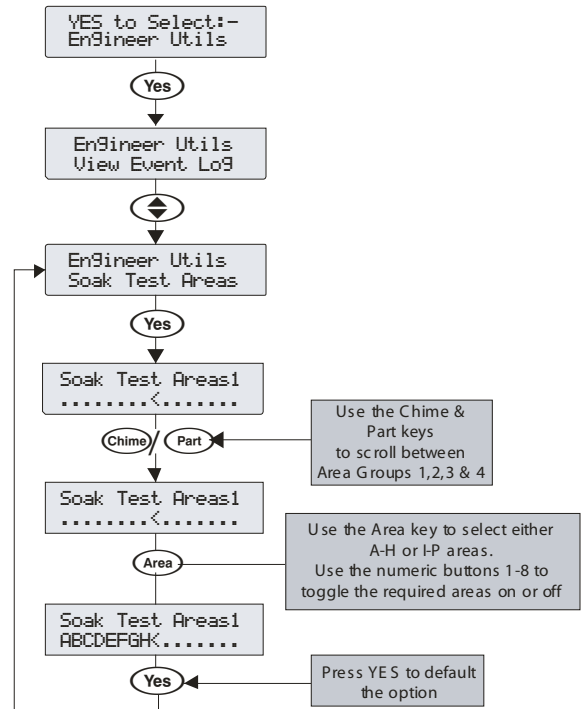

When an area is selected for soak test, the soak test timer is started. Any zones in the selected area with the soak test attribute will be put on soak test for the duration of the soak test timer (see page 62). If the area soak test option is subsequently deselected before the end of the test, all zones are returned to normal operation.

When a zone is on soak test, it will not cause an alarm when activated. However the system will log the event and will notify the user that the zone has failed soak test.

A test failure will not prevent the user arming the system and will be cleared when the engineers code is entered.

At the end of the soak test all zones that have passed the test will be returned to normal operation.

Soak Test Areas 24/48/88/168

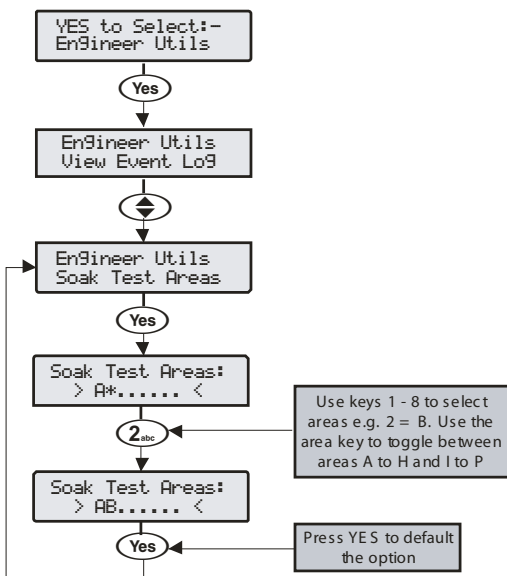

When an area is selected for soak test, the soak test timer is started. Any zones in the selected area with the soak test attribute will be put on soak test for the duration of the soak test timer (see page 62). If the area soak test option is subsequently deselected before the end of the test, all zones are returned to normal operation.

When a zone is on soak test, it will not cause an alarm when activated. However the system will log the event and will notify the user that the zone has failed soak test.

A test failure will not prevent the user arming the system and will be cleared when the engineers code is entered.

At the end of the soak test all zones that have passed the test will be returned to normal operation.

View iD Data

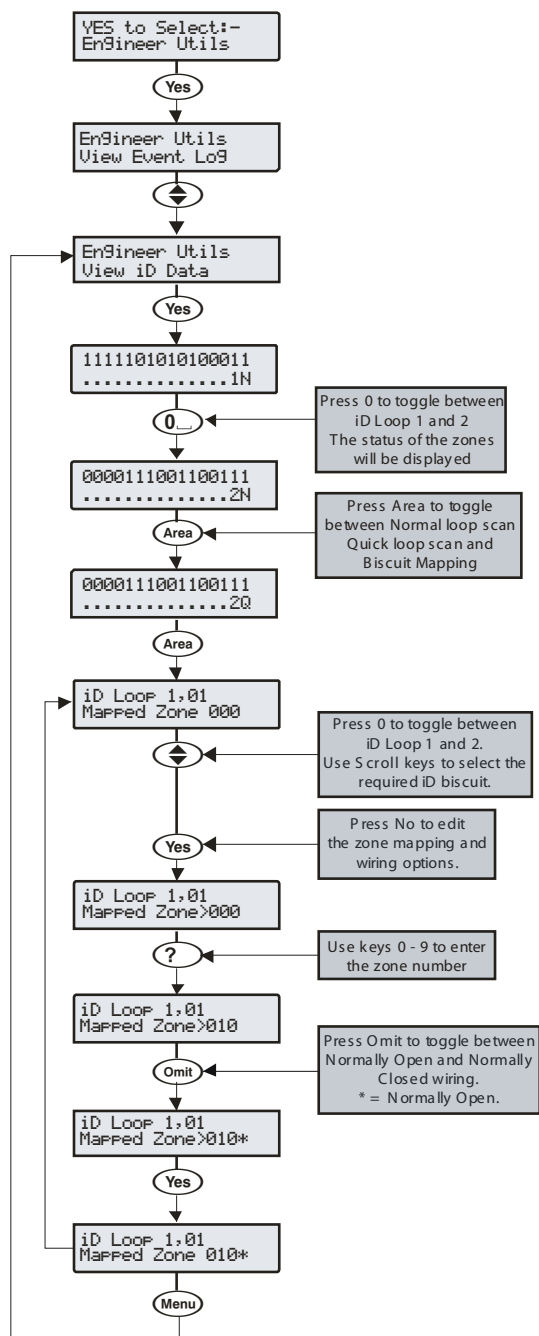

Viewing the iD Data

This option allows the 60IXD expander the iD biscuit data to be viewed to diagnostic purposes. There are two way of viewing the data from the expander:

Normal Scan Mode

This is the normal operation mode of the expander and the data being displayed is the average result of 4 successive scans of the iD loop.

Quick Scan Mode

In this mode the data being displayed is the result of each scan of the iD loop. This mode is useful for identifying problems with biscuits due to interference, high resistance connections etc.

“iD” is a registered trade mark of Chloride Safety System Limited.

Configure Radio

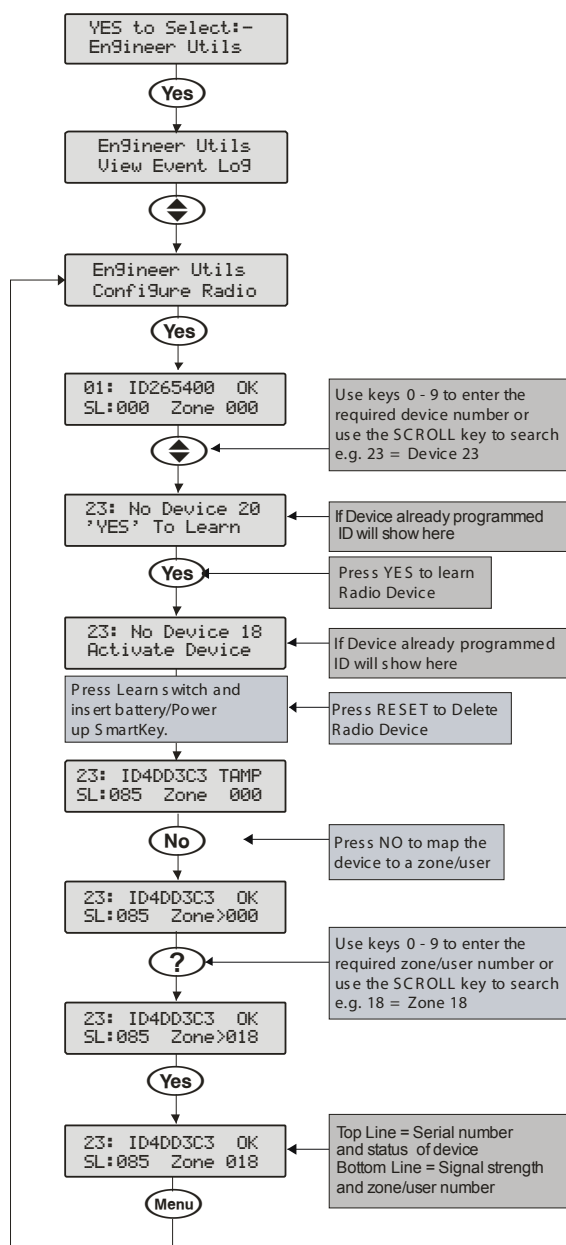

Configuring Radio devices (NOT MT2 Systems)

Up to 32 wireless Radio devices can be learnt on to the system this can be any combination of detectors, mag contacts and remote FOBs. The number of remote FOBs is limited to the maximum number of devices the expander can accept.

Wireless devices can then be mapped on to the system along with conventional detectors.

The top line on the display shows the serial number of the device and also the status i.e. Active, Tamper etc.

The bottom line of the display shows the signal strength and also which zone/user the device is mapped to.

NOTE Signal strength should be greater than 30.
The signal range is between 0 and 90

Deleting Devices

To delete radio devices, select the device number to be deleted then follow the procedure for learning a new device but press the **Reset** button on the keypad when prompted to activate device instead of activating the tamper switch.

Ricochet Diagnostics (MT2 Only)

This menu displays information about the live system, and is split into **Premier Elite SmartKey™** and **Ricochet™** devices via Zones and Users.

Devices

For Devices the following information can be viewed:-

- Routing
- RSSI
- Alarms and Status
- Device visibility
- Time since last message

Premier Elite SmartKey™

For **Premier Elite SmartKey™** the following information can be viewed:-

- Routing
- RSSI
- **Premier Elite SmartKey™** Button
- Status

Interpreting Keypad Displays

Routing

The image below shows that Zone 009 is routing through 14 and then 7 to the expander, for Premier Elite SmartKey™ this may vary depending on where & when the reading is taken. If question marks appear in the display it means the information is not available.

```
Zone 009 PIR
->014->007->XP
```

RSSI

Each value in the image below represents the RSSI levels in dBm at each of the hops. If question marks appear on the display it means the information is not available.

```
Zone 009 PIR
69>> 80>> 57aXP
```

NOTE If question marks appear it could be because either the system has just been powered up and information has not been collected yet, or on large systems the information is not in memory. To populate the display activate the device and the information should appear.

Device Messages

Zone 001 Not Ricochet. The chosen zone does not have a Ricochet device learned to it.

Zone 009 PIR Ms9 ??? mins ago. shows the last time the device communicated this represents the last message and could be a poll, activation or tamper etc.....

Zone 009 PIR >1hr since ms9. This is a warning showing that the last communication from the device was over an hour ago.

Zone 009 PIR No ms9 recvd yet. This display shows that no message has been received yet, this would normally be seen on a recently powered up system, wait 15 minutes from power up before checking the diagnostics information.

Signal Security™

Zone 009 Shock ????. This display shows information relating to signal security on an 8XP-W. 4 windows are available to show information; each window represents two devices, (Odd & Even device slots). Each window could show any of the information detailed in the table below

?	No information is available
_	The chosen device cannot "see" either of the devices
O	The chosen device can see the ODD device(s)
E	The chosen device can see the EVEN device(s)
B	The chosen device can see BOTH devices

Example

```
Zone 009 Shock
_OEB
```

In this example Zone 9 can see the devices as detailed below, use the scroll key to view information about other devices:-

Display	_		O		E		B	
Device	1	2	3	4	5	6	7	8
Can see	x	x	✓	x	x	✓	✓	✓

NOTE On the 32XP-W there are 16 windows to show information from the 32 devices of the system; the format is the same.

Device Status

```
Zone 009 Shock
Status: aaaSpdtt
```

Secure/OK	Active/Fault	Type
a	A	Mag1
a	A	Mag2/Sho
a	A	Reed/PIR
s	S	Poll/Supervision
p	P	Power/Battery
d	D	Device
t	T	Rear
t	T	Front

Premier Elite SmartKey™ Messages

User000 Ricochet Not Ricochet. The chosen user does not have a **Premier Elite SmartKey™** associated with them.

User002 Ricochet Not connected. The **Premier Elite SmartKey™** is not switched on

User002 Ricochet Lo9on Bat OK. Shows the battery is OK and the fob has logged onto the system.

User002 Ricochet Partarm Bat OK. Shows the different messages displayed when the relevant buttons are pressed.

```
User002 Ricochet
Disarm Bat OK
```

```
User002 Ricochet
Fullarm Bat OK
```

User002 Ricochet Aux? Bat OK. Shows which Aux button has been pressed when in Function Mode.

User002 Ricochet Panic Bat OK. Shows the Panic function has been activated

YES to erase unknown keyfobs. Use this option **ONLY** if the panel has been replaced and not all **Premier Elite SmartKey™** are recognised by the new panel, or if the error tone is heard when learning new Premier Elite SmartKey™

NOTE This option **DOES NOT** remove known Premier Elite SmartKey™, use the Delete option in Setup Users.

Ricochet Diagnostics Menu

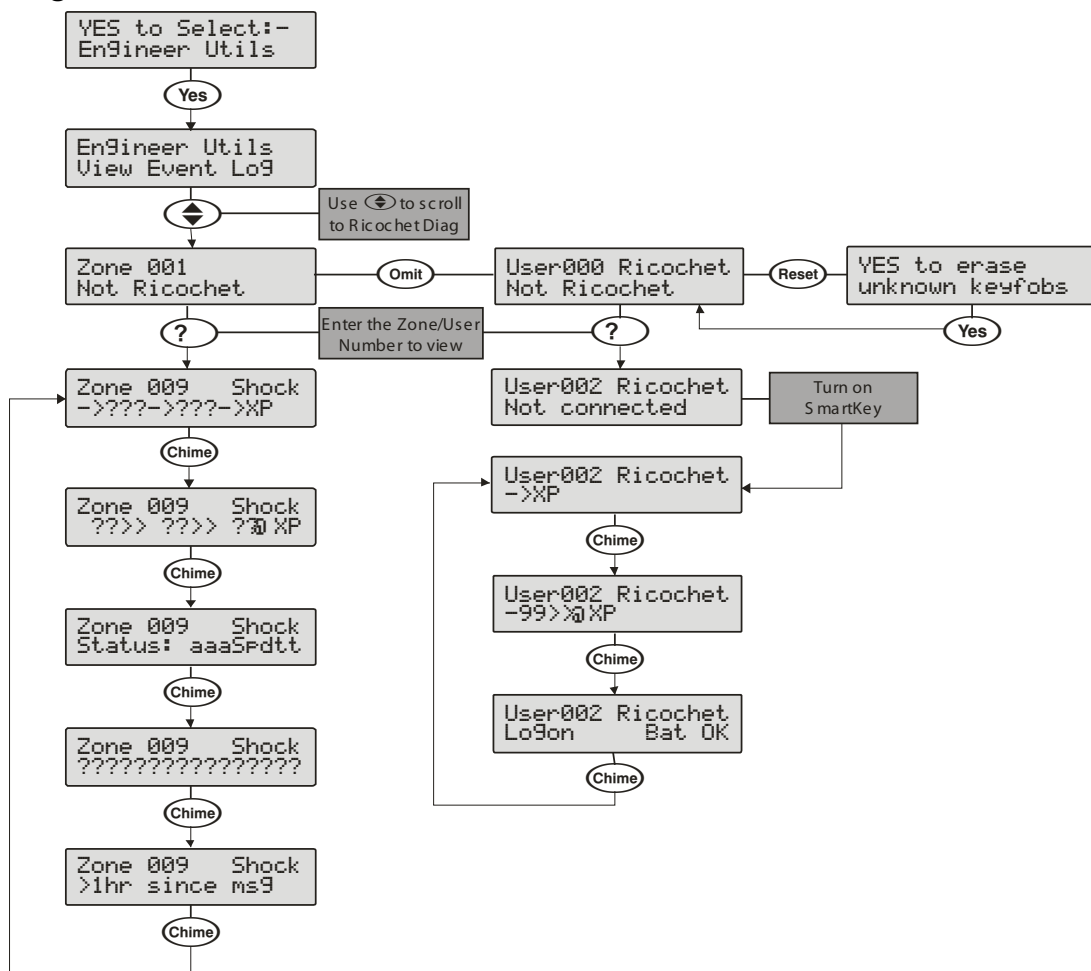

5.10 Programming Part Arms

Alter Part Arms

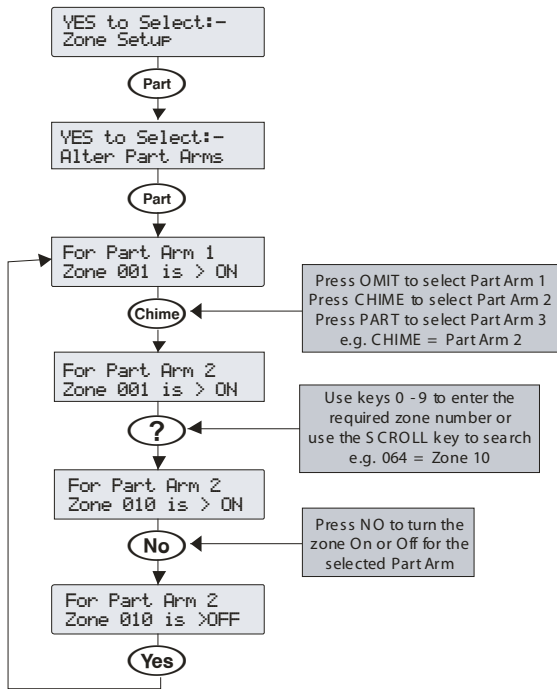

Each area on the system can have up to 3 Part Arms.

When Part Arm 1, 2 or 3 is selected, pre-programmed zones are omitted to allow access to certain parts of the building.

6. Specifications Control Panels

Identifying the Control Panel



Serial Number
Type Code

Type Code	Description
AEO	Premier 24
AEJ	Premier 48
AFG	Premier 48-W 868MHz
AFN	Premier 48-W 433MHz
AEK	Premier 88
AEL	Premier 168
AEZ	Premier 640

Premier Elite 24 (Polymer)

Current

Current Consumption	95mA
Maximum Current Available	
0.3A charge	1.1A

Rated Output

Battery Arrangement	Battery Charge	Rated Output (Amps)	
		12h	24h
1 x 7Ah	0.3A	0.48A	0.19A
	0.75A	1.0A	0.61A

Standby and Recharge Times

EN50131-1	Grade 1	Grade 2
Minimum Standby Period	12h	12h
Maximum Recharge Time	72 Hrs	72 Hrs
PD6662	Grade 1	Grade 2
Standby Period	12 Hrs	12 Hrs
Maximum Recharge Time	72 Hrs	72 Hrs

Power Supply	Type A										
Rated Input:	100V - 240V @ 50/60Hz; 1A										
Rated Output Current @ 55°C:	1.5A MAX										
Rated Output Voltage:	13.&Vdc +/- 2%										
Mains Terminal Block Fuse:	250Vac; 3-3.15A Slow/Medium Blow										
Maximum rating of each power output (note that these are not considered to be "independent power outputs" according to EN50131-6)											
	<table border="1"> <tr> <td>Aux 12V</td> <td>1.0A</td> </tr> <tr> <td>Bell/Strobe</td> <td>1.0A</td> </tr> <tr> <td>Network 1</td> <td>1.0A</td> </tr> <tr> <td>Battery</td> <td>1.6A</td> </tr> <tr> <td>DC+ /DC-</td> <td>1.0A</td> </tr> </table>	Aux 12V	1.0A	Bell/Strobe	1.0A	Network 1	1.0A	Battery	1.6A	DC+ /DC-	1.0A
Aux 12V	1.0A										
Bell/Strobe	1.0A										
Network 1	1.0A										
Battery	1.6A										
DC+ /DC-	1.0A										
Standby Current	95mA										
Output Voltage Range:	13.0V to 13.9V										
Maximum Ripple Voltage:	0.5V pk-pk										
Battery type:	sealed lead acid, up to 7Ah, Maximum recharge time 72h										
Battery Low Voltage Signal:	9.5V										
Power Output Fault signal:	10.5V (with mains present)										
Deep Discharge protection:	8.1V										
Over voltage protection trigger:	16V										
Fuses	F1 (900mA) Auxiliary 12V Power fuse (electronic PTC) F2 (900mA) Digicom Power (electronic PTC) F3 (900mA) Network 1 fuse (electronic PTC) F4 (900mA) Bell/Strobe fuse (electronic PTC) F6 (1.6 Amp) Battery fuse (electronic PTC)										

Housing	3mm Polycarbonate
Dimensions (W x H x D)	305mm x 263mm x 98mm
Battery Compartment	One 12V 7.0Ah battery
Packed Weight	1.5 Kg (Approx)

Premier Elite 24 (Metal)

Current

Current Consumption	95mA
---------------------	------

Maximum Current Available	
0.75A charge	1.0A
0.3A charge	1.9A

Rated Output

Battery Arrangement	Battery Charge	Rated Output (Amps)			
		12h	24h	30h	60h
1 x 7Ah	0.3A	0.48A	0.19A	0.13A	0.021A
	0.75A	1.0A	0.61A	0.47A	0.18A

Standby and Recharge Times

EN50131-1	Grade 1	Grade 2	Grade 3
Minimum Standby Period	12h	12h	30h *
Maximum Recharge Time	72 Hrs	72 Hrs	24 Hrs
PD6662	Grade 1	Grade 2	Grade 3
Standby Period	12 Hrs	12 Hrs	24 Hrs **
Maximum Recharge Time	72 Hrs	72 Hrs	24 Hrs

*30h if MAINS FAIL is reported to ARC, otherwise 60h

**This time may be halved if mains failure is signalled to an ARC

Jumper Settings

Battery Arrangement	Recharge Time	Battery Charge Selector
1 x 7Ah	< 24Hrs	0.3 A
	< 72Hrs	0.3 A

Power Supply	Type A										
Rated Input:	220V - 240V @50/60Hz; 1A										
Rated Output Current@40°C:	2.5A MAX										
Rated Input:	100VV - 120V @50/60Hz; 1A										
Rated Output Current@40°C:	2.3A MAX										
Rated Output Voltage:	13.&Vdc +/- 2%										
Mains Terminal Block Fuse:	250Vac; 3-3.15A Slow/Medium Blow										
Maximum rating of each power output (note that these are not considered to be "independent power outputs" according to EN50131-6)											
	<table border="1"> <tr> <td>Aux 12V</td> <td>1.0A</td> </tr> <tr> <td>Bell/Strobe</td> <td>1.0A</td> </tr> <tr> <td>Network 1</td> <td>1.0A</td> </tr> <tr> <td>Battery</td> <td>1.6A</td> </tr> <tr> <td>DC+ /DC-</td> <td>1.0A</td> </tr> </table>	Aux 12V	1.0A	Bell/Strobe	1.0A	Network 1	1.0A	Battery	1.6A	DC+ /DC-	1.0A
Aux 12V	1.0A										
Bell/Strobe	1.0A										
Network 1	1.0A										
Battery	1.6A										
DC+ /DC-	1.0A										
Standby Current	95mA										
Output Voltage Range:	13.0V to 13.9V										
Maximum Ripple Voltage:	0.5V pk-pk										
Battery type:	sealed lead acid, up to 18Ah, Maximum recharge time 24h (0.75A charge rate) 72h (0.3A charge rate)										
Battery Low Voltage Signal:	9.5V										
Power Output Fault signal:	10.5V (with mains present)										
Deep Discharge protection:	8.1V										
Over voltage protection trigger:	16V										
Fuses	F1 (900mA) Auxiliary 12V Power fuse (electronic PTC) F2 (900mA) Digicom Power (electronic PTC) F3 (900mA) Network 1 fuse (electronic PTC) F4 (900mA) Bell/Strobe fuse (electronic PTC) F6 (1.6 Amp) Battery fuse (electronic PTC)										

Housing	1mm Mild Steel
Dimensions (W x H x D)	315mm x 415mm x 100mm
Battery Compartment	Up tp one 18Ah battery
Packed Weight	4.5 Kg (Approx)

Premier Elite 48-W

Current

Current Consumption	150mA
Maximum Current Available	

0.3A charge	1.0A
-------------	------

Rated Output

Battery Arrangement	Battery Charge	Rated Output (Amps)	
		12h	
1 x 7Ah	0.3A	0.433A	

Standby and Recharge Times

EN50131-1	Grade 1	Grade 2
Minimum Standby Period	12h	12h
Maximum Recharge Time	72 Hrs	72 Hrs
PD6662	Grade 1	Grade 2
Standby Period	12 Hrs	12 Hrs
Maximum Recharge Time	72 Hrs	72 Hrs

Power Supply	Type A	
Rated Input:	100V - 240V @ 50/60Hz; 1A	
Rated Output Current @ 55°C:	1.5A MAX	
Rated Output Voltage:	13.&Vdc +/- 2%	
Mains Terminal Block Fuse:	250Vac; 3-3.15A Slow/Medium Blow	
Maximum rating of each power output (note that these are not considered to be "independent power outputs" according to EN50131-6)		
	Aux 12V	1.0A
	Bell/Strobe	1.0A
	Network 1	1.0A
	Battery	1.6A
	DC+/DC-	1.0A
Standby Current	150mA	
Output Voltage Range:	13.0V to 13.9V	
Maximum Ripple Voltage:	0.5V pk-pk	
Battery type:	sealed lead acid, up to 7Ah, Maximum recharge time 72h	
Battery Low Voltage Signal:	9.5V	
Power Output Fault signal:	10.5V (with mains present)	
Deep Discharge protection:	8.1V	
Over voltage protection trigger:	16V	
Fuses	F6 PTC (0.9A) Auxiliary 12V Power fuse F4 PTC (0.9 A) Network 1 fuse F5 PTC (0.9 A) Bell/Strobe fuse	

Housing	3mm Polycarbonate
Dimensions (W x H x D)	305mm x 263mm x 98mm
Battery Compartment	One 12V 7.0Ah battery
Packed Weight	1.7 Kg (Approx)

Premier Elite 48/88/168

Current

Current Consumption	125mA
Maximum Current Available	
0.75A charge	1.0A
0.3A charge	1.9A

Rated Output

Battery Arrangement	Battery Charge	Rated Output (Amps)			
		12h	24h	30h	60h
1 x 7Ah	0.3A	0.458A	0.166A	0.108A	
1 x 17Ah	0.3A	1.29A	0.583A	0.441A	0.158A
	0.75A	1.0A	0.583A	0.441A	0.1588A

Standby and Recharge Times

EN50131-1	Grade 1	Grade 2	Grade 3
Minimum Standby Period	12h	12h	30h *
Maximum Recharge Time	72 Hrs	72 Hrs	24 Hrs
PD6662	Grade 1	Grade 2	Grade 3
Standby Period	12 Hrs	12 Hrs	24 Hrs **
Maximum Recharge Time	72 Hrs	72 Hrs	24 Hrs

*30h if MAINS FAIL is reported to ARC, otherwise 60h

**This time may be halved if mains failure is signalled to an ARC

Jumper Settings

Battery Arrangement	Recharge Time	Battery Charge Selector
1 x 7Ah	< 24Hrs	0.3 A
1 x 17Ah	< 24Hrs	0.75 A
	< 72Hrs	0.3 A

Power Supply	Type A	
Rated Input:	220V - 240V @50/60Hz; 1A	
Rated Output Current@40°C:	2.5A MAX	
Rated Input:	100VV - 120V @50/60Hz; 1A	
Rated Output Current@40°C:	2.3A MAX	
Rated Output Voltage:	13.&Vdc +/- 2%	
Mains Terminal Block Fuse:	250Vac; 3-3.15A Slow/Medium Blow	
Maximum rating of each power output (note that these are not considered to be "independent power outputs" according to EN50131-6)		
	Aux 12V	1.0A
	Bell/Strobe	1.0A
	Network 1 & 2	1.0A
	Battery	1.6A
	DC+/DC-	1.0A
Standby Current	125mA	
Output Voltage Range:	13.0V to 13.9V	
Maximum Ripple Voltage:	0.5V pk-pk	
Battery type:	sealed lead acid, up to 18Ah, Maximum recharge time 72h	
Battery Low Voltage Signal:	9.5V	
Power Output Fault signal:	10.5V (with mains present)	
Deep Discharge protection:	8.1V	
Over voltage protection trigger:	16V	
Fuses	F1 (1Amp) Auxiliary 12V Power fuse F2 (1.6 Amp) Battery fuse (electronic PTC) F3 (1 Amp) Network 1 fuse F4 (1 Amp) Bell/Strobe fuse F5 (1 Amp) Network 2 fuse (168 only)	

Housing	1mm Mild Steel
Dimensions (W x H x D)	315mm x 415mm x 100mm
Battery Compartment	Up to one 18Ah battery
Packed Weight	4.5 Kg (Approx)

Premier Elite 640

Current

Current Consumption	125mA
Maximum Current Available	
0.75A charge	1.0A

Rated Output

Battery Arrangement	Battery Charge	Rated Output (Amps)			
		12h	24h	30h	60h
1 x 17Ah	0.75A	1.0A	0.558A	0.416A	0.133A

Standby and Recharge Times

EN50131-1	Grade 1	Grade 2	Grade 3
Minimum Standby Period	12h	12h	30h *
Maximum Recharge Time	72 Hrs	72 Hrs	24 Hrs
PD6662	Grade 1	Grade 2	Grade 3
Standby Period	12 Hrs	12 Hrs	24 Hrs **
Maximum Recharge Time	72 Hrs	72 Hrs	24 Hrs

*30h if MAINS FAIL is reported to ARC, otherwise 60h

**This time may be halved if mains failure is signalled to an ARC

Power Supply	Type A	
Rated Input:	220V - 240V @50/60Hz; 1A	
Rated Output Current@40°C:	2.5A MAX	
Rated Input:	100VV - 120V @50/60Hz; 1A	
Rated Output Current@40°C:	2.3A MAX	
Rated Output Voltage:	13.&Vdc +/- 2%	
Mains Terminal Block Fuse:	250Vac; 3-3.15A Slow/Medium Blow	
Maximum rating of each power output (note that these are not considered to be "independent power outputs" according to EN50131-6)		
	Aux 12V	1.0A
	Bell/Strobe	1.0A
	Network 1 & 2	1.0A
	Battery	1.6A
	DC+/DC-	1.0A
Standby Current	150mA	
Output Voltage Range:	13.0V to 13.9V	

Maximum Ripple Voltage:	0.5V pk-pk
Battery type:	sealed lead acid, up to 18Ah, Maximum recharge time 72h
Battery Low Voltage Signal:	9.5V
Power Output Fault signal:	10.5V (with mains present)
Deep Discharge protection:	8.1V
Over voltage protection trigger:	16V
Fuses (Electronic PTC)	F3 (1600 mA) Battery F4 (250mA) Speaker F5 (900mA) Network 1 F6 (900mA) Bell/Strobe F7 (900mA) Network 2 F8 (900mA) Network 3 F9 (900mA) Network 4 F10 (900mA) Network 5 F11 (900mA) Network 6 F12 (900mA) Network 7 F13 (900mA) Network 8 F14 (900mA) Auxiliary 12V

Housing	1mm Mild Steel
Dimensions (W x H x D)	315mm x 415mm x 100mm
Battery Compartment	Up to one 18Ah battery
Packed Weight	4.5 Kg (Approx)

General (All Models)

Data Network	4-wire standard 7/0.2 alarm cable up to 500m Star, Daisy Chain or any combination of the two
Remote Keypads 24 & 48 & 48-W 88 168 640	Up to 4 Up to 8 Up to 16 Up to 64
Expanders 24 48 & 48-W 88 168 640	Up to 2 Up to 4 Up to 8 Up to 16 Up to 64
Output Modules 24 48 & 48-W 88 168 640	1 Up to 2 Up to 4 Up to 8 Up to 32
Zones 24 48 48-W 88 168 640	8 expandable to 24 8 expandable to 48 4 expandable to 48 8 expandable to 88 8 expandable to 168 0 expandable to 640-
EOL Resistor Values EOL Resistor Contact Resistor Fault Resistor 0 - 1k 1k1 to 4k 4k1 to 5k6 5k7 to 8k 8k1 to 20k (30k) 21k+ (30k+)	(Alternatives Available) 2k2 (3k3) 4k7 (3k3) 2k2 Zone Short Zone Secure Zone Fault Zone Active Zone Mask Zone Tamper
Digicom Outputs Outputs 1 to 8	100mA switched to 0V
Panel Outputs PG1 (24 only) Outputs 1 & 2 (48/88/168) Outputs 3 & 4 (88/168) Output 5 (88/168)	100mA -ve 500mA switched to 0V 500mA switched to 12V 3 Amp Relay

Siren Outputs Bell Trigger Strobe Trigger	1A switched to 0V 1A switched to 0V
Speaker Output	Minimum load 8Ω

Environmental (All Models)

Operating Temperature	-10°C to +40°C
Storage Temperature	-20°C o +60°C
Maximum Humidity	95% non-condensing
EMC Environment	Residential Commercial Light Industrial Industrial

Inhibit Functions

For Alarms and Tamper is controlled by the Swinger shutdown counter which is programmable and is defaulted to 3. Please see page 46 and 69.

Minimum Logical Keys

10,000 for 4 digit code*

100,000 for 5 digit code*

1,000,000 for 6 digit code*

The number of disallowed codes = 0*



NOTE

User codes must be programmed as a 6 digit code to comply with INCERT.



NOTE

Dependant on the use of the Black Listed codes function available via Wintex, a maximum of 16 codes may be Black Listed

Calibration Checks & Adjustments

There are no calibration checks or adjustments available on the control panel.

Signal & Message Processing Indications

First alarm indications followed by any other events during the set period will scroll and can be controlled by the  key on the keypad.

Memory Support

A memory support battery is not required.

Compliance Label

If the alarm system is programmed to NOT conform with EN50131-1 or EN50131-3 or is installed to Grade 1 the compliance label MUST be removed.

Engineer Access

Global Options/System Configuration Option 10 see page 64 set to Engineer only EN50131 and User + Engineer for PD6662.

Microprocessor Identification

Premier Elite 24/48/88/168	24LC256I/P
Premier Elite 640	25LC1024I/P

Remote Keypads

Electrical

Operating Voltage	10 - 13.7VDC
ACE Type	B
Current Consumption without Prox	
Quiescent (Not Backlit)	25mA
Alarm (Not Backlit)	45mA
Fully Backlit	100mA
Alarm + Fully Backlit	145mA
Current Consumption with Prox	
Quiescent (Not Backlit)	85mA
Alarm (Not Backlit)	105mA
Fully Backlit	185mA
Alarm + Fully Backlit	205mA
Data Network	4-wire standard 7/0.2 alarm cable up to 500m Star, Daisy Chain or any combination of the two
Keypad Type	
LCD	32 Character LCD
LCDL	32 Character large LCD
LCDP	LCD + Prox Reader
LCDLP	LCDL + Prox Reader
Zones	2
EOL Resistor Values	(Alternatives Available)
EOL Resistor	2k2 (3k3)
Contact Resistor	4k7 (3k3)
Fault Resistor	2k2
0 - 1k	Zone Short
1k1 to 4k	Zone Secure
4k1 to 5k6	Zone Fault
5k7 to 8k	Zone Active
8k1 to 20k (30k)	Zone Mask
21k+ (30k+)	Zone Tamper
Output	100mA switched to 0V
Back Lighting	Fully adjustable
Speaker Output (LCDL/LCDLP)	Minimum load 8Ω
Speaker Volume (LCDL/LCDLP)	Fully adjustable
Proximity Reader (LCDP/LCDLP)	Tag

Environmental

Operating Temperature	-10°C (+14°F) to +55°C (+131°F)
Storage Temperature	-20°C (-4°F) to +60°C (+140°F)
Maximum Humidity	95% non-condensing
EMC Environment	Residential Commercial Light Industrial Industrial

Physical

Dimensions (W x H x D)	145mm x 115mm x 30mm
Packed Weight	260g Approx.

Zone Expanders

Electrical

Operating Voltage	9 - 13.7VDC
ACE Type	B
Current Consumption 4XP 8XP	
Quiescent	65mA
Alarm (Nothing Connected)	65mA
Data Network	4-wire standard 7/0.2 alarm cable up to 500m Star, Daisy Chain or

	any combination of the two
Zones	
8XP	8 DP or EOL zones
60XD	60 iD zones (2 loops)
EOL Resistor Values	(Alternatives Available)
EOL Resistor	2k2 (3k3)
Contact Resistor	4k7 (3k3)
Fault Resistor	2k2
0 - 1k	Zone Short
1k1 to 4k	Zone Secure
4k1 to 5k6	Zone Fault
5k7 to 8k	Zone Active
8k1 to 20k (30k)	Zone Mask
21k+ (30k+)	Zone Tamper
Outputs	
Outputs 1 & 2 (4XP)	100mA switched to 0V
Outputs 1 - 8 (8XP)	100mA switched to 0V
Speaker Output (4XP & 8XP)	Minimum load 8Ω

Environmental

Operating Temperature	-10°C (+14°F) to +55°C (+131°F)
Storage Temperature	-20°C (-4°F) to +60°C (+140°F)
Maximum Humidity	95% non-condensing
EMC Environment	Residential Commercial Light Industrial Industrial

Physical

Dimensions (W x H x D)	170mm x 140mm x 35mm
Packed Weight	200g Approx.

Output Expanders

Electrical

Operating Voltage	9 - 13.7VDC
ACE Type	B
Current Consumption	
Quiescent	65mA
Alarm (Nothing Connected)	65mA
Network	4-wire standard 7/0.2 alarm cable up to 250m Star, Daisy Chain or any combination of the two
Bank 1 Outputs	
Outputs 1 to 8	100mA switched to 0V
Bank 2 Outputs	
Outputs 1 to 8	100mA switched to 0V

Environmental

Operating Temperature	-10°C (+14°F) to +55°C (+131°F)
Storage Temperature	-20°C (-4°F) to +60°C (+140°F)
Maximum Humidity	95% non-condensing
EMC Environment	Residential Commercial Light Industrial Industrial

Physical

Dimensions (W x H x D)	170mm x 140mm x 35mm
Packed Weight	200g Approx.

Standards



2004/108/EC (CE directive): Hereby, Texecom declares that this device is in compliance with the essential requirements and other relevant provisions of Directive 2004/108/EC.



WEEE Directive: 2002/96/EC (WEEE directive): Products marked with this symbol cannot be disposed of as unsorted municipal waste in the European Union. For proper recycling, return this product to your local supplier upon the purchase of equivalent new equipment, or dispose of it at designated collection points. For more information see: www.recyclethis.info.

RoHS Directive: 2002/95/EC RoHS Compliant. Hereby, Texecom declares that this device does not contain lead, mercury, cadmium, hexavalent chromium, polybrominated biphenyls (PBB) or polybrominated diphenyl ethers (PBDE) in more than the percentage specified by EU directive 2002/95/EC, except exemptions stated in EU directive 2002/95/EC annex.

This product is suitable for use in systems designed to comply with EN 50131-1, EN50131-3 and PD6662 at Grade 3 and Environmental Class II.

Warranty

All Texecom products are designed for reliable, trouble free operation. Quality is carefully monitored by extensive computerised testing. As a result the control panel is covered by a two-year warranty against defects in materials or workmanship.

As the control panel is not a complete alarm system but only a part thereof, Texecom cannot accept responsibility or liability for any damages whatsoever based on a claim that the control panel failed to function correctly.

Due to our policy of continuous improvements Texecom reserve the right to change specification without prior notice.

Keypads and Expanders are protected by UK & International Registered Design. Registered Design Numbers: 2089016 and 3004996.

Premier & Premier Elite are trademarks of Texecom.

Notes:

Notes

Texecom

Designed to Perform

Texecom Limited, Bradwood Court, St. Crispin Way, Haslingden, Lancashire BB4 4PW,
England.

Technical Support:

UK Customers Tel: 08456 300 600

(Calls charged at local rate from a BT landline. Calls from other networks may vary.)

International Customers Tel: +44 1706 233875

Email: techsupport@texe.com

© Texecom Limited 2012

INS176-9



Certificate Number : FM 35285